

Moxa Managed DSL Ethernet Extender User's Manual

First Edition, March 2013

www.moxa.com/product

MOXA®

© 2013 Moxa Inc. All rights reserved.

Moxa Managed DSL Ethernet Extender User's Manual

The software described in this manual is furnished under a license agreement and may be used only in accordance with the terms of that agreement.

Copyright Notice

© 2013 Moxa Inc. All rights reserved.

Trademarks

The MOXA logo is a registered trademark of Moxa Inc.
All other trademarks or registered marks in this manual belong to their respective manufacturers.

Disclaimer

Information in this document is subject to change without notice and does not represent a commitment on the part of Moxa.

Moxa provides this document as is, without warranty of any kind, either expressed or implied, including, but not limited to, its particular purpose. Moxa reserves the right to make improvements and/or changes to this manual, or to the products and/or the programs described in this manual, at any time.

Information provided in this manual is intended to be accurate and reliable. However, Moxa assumes no responsibility for its use, or for any infringements on the rights of third parties that may result from its use.

This product might include unintentional technical or typographical errors. Changes are periodically made to the information herein to correct such errors, and these changes are incorporated into new editions of the publication.

Technical Support Contact Information

www.moxa.com/support

Moxa Americas

Toll-free: 1-888-669-2872
Tel: +1-714-528-6777
Fax: +1-714-528-6778

Moxa Europe

Tel: +49-89-3 70 03 99-0
Fax: +49-89-3 70 03 99-99

Moxa India

Tel: +91-80-4172-9088
Fax: +91-80-4132-1045

Moxa China (Shanghai office)

Toll-free: 800-820-5036
Tel: +86-21-5258-9955
Fax: +86-21-5258-5505

Moxa Asia-Pacific

Tel: +886-2-8919-1230
Fax: +886-2-8919-1231

Table of Contents

1. About this Manual	1-1
2. Getting Started.....	2-1
Serial Console Configuration (115200, None, 8, 1, VT100).....	2-2
Configuration via Telnet Console.....	2-4
Configuration via Web Browser.....	2-6
Disabling Telnet and Browser Access.....	2-7
3. Featured Functions	3-1
Product Overview	3-2
Wiring the Devices	3-2
Getting Started	3-2
4. Diagnostics, Management, and Performance.....	4-1
On-site Troubleshooting	4-2
Remote Management	4-3
Performance	4-4
A. MIB Groups	A-1

About this Manual

Thank you for purchasing Moxa's managed DSL Ethernet extender. Read this user's manual to learn how to connect your DSL Ethernet extender to Ethernet-enabled devices in industrial applications.

The following two chapters are covered in this user manual:

❑ **Getting Started**

This chapter explains the initial installation process for the DSL Ethernet extender. There are three ways to access configuration settings: serial console, Telnet console, and web console.

❑ **Featured Functions**

This chapter explains how to access various configuration, monitoring, and administration functions. These functions can be accessed via serial, Telnet, or web console. The web console is the most user-friendly way to configure the DSL Ethernet extender. In this chapter, we will use the web console interface to introduce the functions.

2

Getting Started

This chapter explains how to install a Moxa DSL Ethernet extender for the first time. There are three ways to access the configuration settings: serial console, Telnet console, and web console. If you do not know the DSL Ethernet extender's IP address, you can open the serial console by connecting the DSL Ethernet extender to a PC's COM port with a short serial cable. You can open the Telnet or web console over an Ethernet LAN or over the Internet.

The following topics are covered in this chapter:

- ❑ **Serial Console Configuration (115200, None, 8, 1, VT100)**
- ❑ **Configuration via Telnet Console**
- ❑ **Configuration via Web Browser**
- ❑ **Disabling Telnet and Browser Access**

Serial Console Configuration (115200, None, 8, 1, VT100)

- NOTE**
- You cannot connect to the serial and Telnet console at the same time.
 - You can connect to the web console and another console (serial or Telnet) at the same time. However, we strongly recommend that you do NOT do so. Following this advice will allow you to maintain better control over the Moxa DSL Ethernet extender's configuration.

- NOTE** We recommend **using PComm Terminal Emulator** when opening the serial console. This software can be downloaded free of charge from the Moxa website.

Before running PComm Terminal Emulator, use an RJ45 to DB9-F (or RJ45 to DB25-F) cable to connect the Moxa DSL Ethernet extender's console port to your PC's COM port (generally COM1 or COM2, depending on how your system is set up).

After installing PComm Terminal Emulator, open the Moxa DSL Ethernet extender's serial console as follows:

1. From the Windows desktop, click **Start → Programs → PComm Lite 1.3 → Terminal Emulator**.

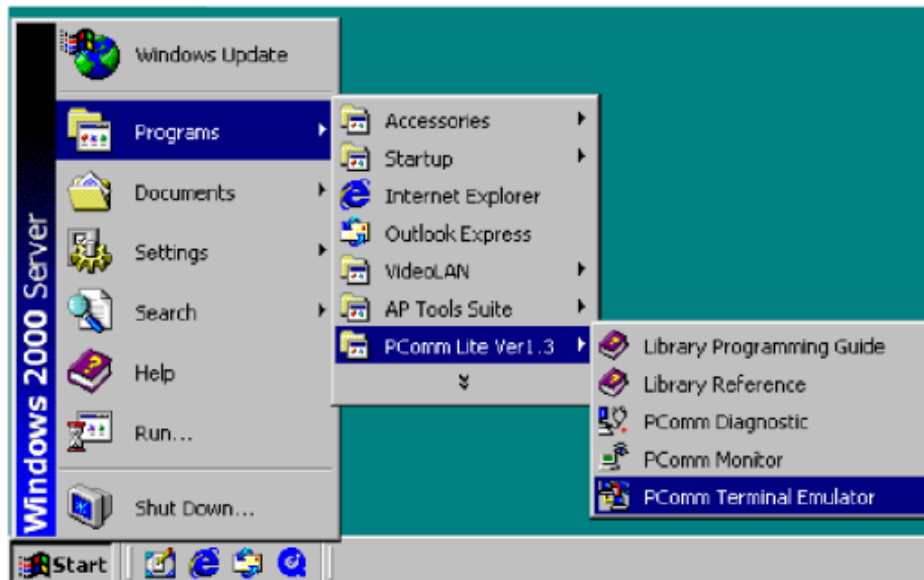

2. Select **Open** under the **Port Manager** menu to open a new connection.

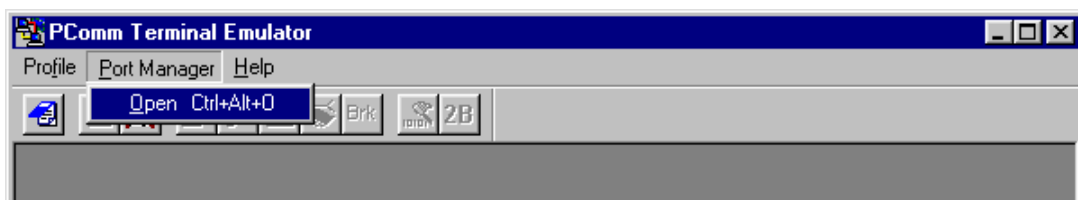

3. The **Property** window should open. On the **Communication Parameter** tab for **Ports**, select the COM port that is being used for the console connection. Set the other fields as follows: **115200** for **Baud Rate**, **8** for **Data Bits**, **None** for **Parity**, and **1** for **Stop Bits**.

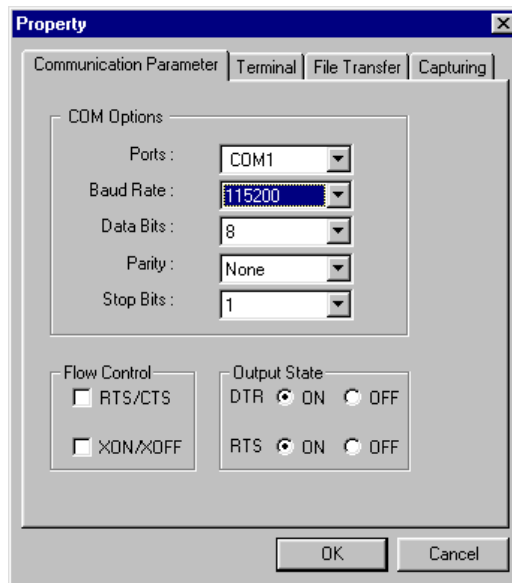

4. On the **Terminal** tab, select **VT100** for **Terminal Type**, and then click **OK** to continue.

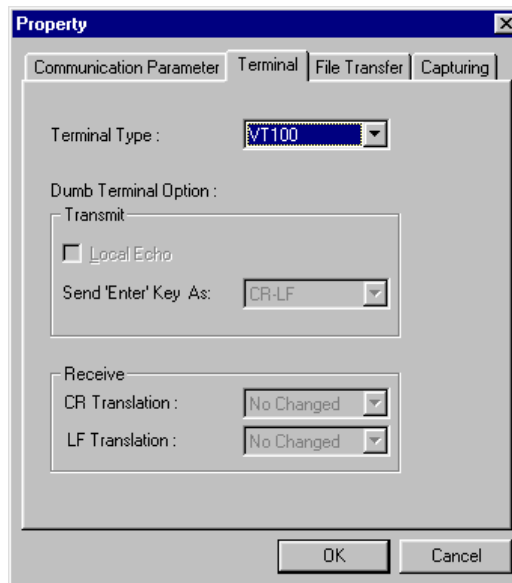

5. In the terminal window, the Moxa DSL Ethernet extender will prompt you to select a terminal type. Enter **1** to select **ansi/vt100** and then press **Enter**.

```
MOXA EtherDevice Switch IKS-6726
Console terminal type (1: ansi/vt100, 2: vt52) : 1
```

6. The serial console will prompt you to log in. Press **Enter** and select **admin** or **user**. Use the down arrow key on your keyboard to select the **Password** field and enter a password if desired. This password will be required to access any of the consoles (web, serial, Telnet). If you do not wish to create a password, leave the **Password** field blank and press **Enter**.

```

Model :          IEX-402-VDSL2
Name :          Industrial Ethernet Extender 00002
Location :      Extender Location

Firmware Version : V1.0
Serial No :     00001
IP :           192.168.127.252
MAC Address :   00-00-00-00-00-01
Product Revision : 1+-----+
+-----+-----+ | admin | |-----+
| Account : [admin] | user | |
| Password : +-----+ |
+-----+-----+

```

7. The **Main Menu** of the Moxa DSL Ethernet extender's serial console should appear. (In PComm Terminal Emulator, you can adjust the font by selecting **Font...** from the **Edit** menu.)

```

1.Basic Settings - Basic settings for network and system parameter.
2.SNMP Settings - The settings for SNMP.
3.Link Fault Pass-Thru - The settings for Link Fault Pass-Through.
4.Diagnosis - Ping command and the settings for Mirror port, LLDP.
5.Monitor - Monitor a port and network status.
6.System log - The settings for Syslog and Event log.
7.Exit - Exit
- Use the up/down arrow keys to select a category,
and then press Enter to select. -

```

8. Use the following keys on your keyboard to navigate through the Moxa DSL Ethernet extender's serial console:

Key	Function
Up, down, right, left arrow keys,Tab	Move the onscreen cursor
Enter	Display and select options
Space	Toggle options
Esc	Previous menu

Configuration via Telnet Console

Opening the Moxa DSL Ethernet extender's Telnet or web console over a network requires that the PC host and the Moxa DSL Ethernet extender are on the same logical subnet. You may need to adjust your PC host's IP address and subnet mask. By default, the Moxa DSL Ethernet extender's IP address is 192.168.127.253 and the subnet mask is 255.255.255.0 (referred to as a Class B network). Your PC's IP address must be set to 192.168.xxx.xxx if the subnet mask is 255.255.0.0, or to 192.168.127.xxx if the subnet mask is 255.255.255.0.

NOTE To connect to the Moxa DSL Ethernet extender's Telnet or web console, your PC host and the Moxa DSL Ethernet extender must be on the same logical subnet.

NOTE When connecting to the Moxa DSL Ethernet extender's Telnet or web console, first connect one of the Moxa DSL Ethernet extender's Ethernet ports to your Ethernet LAN, or directly to your PC's Ethernet port. You may use either a straight-through or a cross-over Ethernet cable.

NOTE The Moxa DSL Ethernet extender's default IP address is 192.168.127.253.

After making sure that the Moxa DSL Ethernet extender is connected to the same LAN and logical subnet as your PC, open the Moxa DSL Ethernet extender's Telnet console as follows:

1. Click **Start → Run** from the Windows Start menu and then Telnet to the Moxa DSL Ethernet extender's IP address from the Windows **Run** window. You may also issue the Telnet command from a DOS prompt.

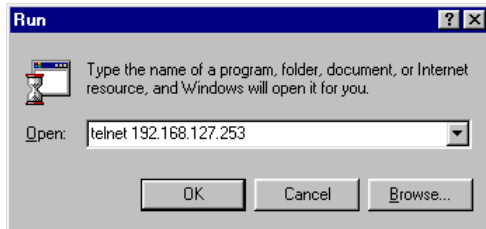

2. In the terminal window, the Telnet console will prompt you to select a terminal type. Type **1** to choose **ansi/vt100**, and then press **Enter**.

```
Moxa EtherDevice Switch IEX-402-VDSL2
Console terminal type (1: ansi/vt100, 2: vt52) : 1|
```

3. The Telnet console will prompt you to log in. Press **Enter** and then select **admin** or **user**. Use the down arrow key on your keyboard to select the **Password** field and enter a password if desired. This password will be required to access any of the consoles (web, serial, Telnet). If you do not wish to create a password, leave the **Password** field blank and press **Enter**.

```
Model : IEX-402-VDSL2
Name : Industrial Ethernet Extender 00002
Location : Extender Location

Firmware Version : V1.0
Serial No : 00001
IP : 192.168.127.252
MAC Address : 00-00-00-00-00-01
Product Revision : 1+-----+
+-----+ | admin | |-----+
| Account : [admin] | user | |
| Password : +-----+ |
+-----+ |-----+
```

4. The **Main Menu** of the Moxa DSL Ethernet extender's Telnet console should appear.

```
1.Basic Settings - Basic settings for network and system parameter.
2.SNMP Settings - The settings for SNMP.
3.Link Fault Pass-Thru - The settings for Link Fault Pass-Through.
4.Diagnosis - Ping command and the settings for Mirror port, LLDP.
5.Monitor - Monitor a port and network status.
6.System log - The settings for Syslog and Event log.
7.Exit - Exit
- Use the up/down arrow keys to select a category,
and then press Enter to select. -
```

5. In the terminal window, select **Preferences...** from the **Terminal** menu on the menu bar.
6. The **Terminal Preferences** window should appear. Make sure that **VT100 Arrows** is checked.

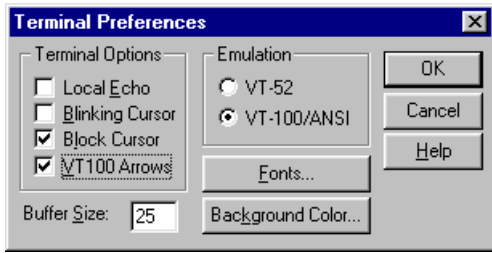

- 7. Use the following keys on your keyboard to navigate through the Moxa DSL Ethernet extender’s Telnet console:

Key	Function
Up, down, right, left arrow keys, Tab	Move the onscreen cursor
Enter	Display and select options
Space	Toggle options
Esc	Previous menu

NOTE The Telnet console looks and operates in precisely the same manner as the serial console.

Configuration via Web Browser

The Moxa DSL Ethernet extender’s web console is a convenient platform for modifying device configuration and accessing the built-in monitoring and network administration functions. You can open the Moxa DSL Ethernet extender’s web console using a standard web browser, such as Internet Explorer.

NOTE To connect to the Moxa DSL Ethernet extender’s Telnet or web console, your PC host and the Moxa DSL Ethernet extender must be on the same logical subnet.

NOTE If the Moxa DSL Ethernet extender is configured for other VLAN settings, you must make sure that your PC host is on the management VLAN.

NOTE When connecting to the Moxa DSL Ethernet extender’s Telnet or web console, first connect one of the Moxa DSL Ethernet extender’s Ethernet ports to your Ethernet LAN, or directly to your PC’s Ethernet port. You may use either a straight-through or a cross-over Ethernet cable.

NOTE The Moxa DSL Ethernet extender’s default IP address is 192.168.127.253.

After making sure that the Moxa DSL Ethernet extender is connected to the same LAN and logical subnet as your PC, open the Moxa DSL Ethernet extender’s web console as follows:

- 1. Connect your web browser to the Moxa DSL Ethernet extender’s IP address by entering it in the **Address** or **URL** field.

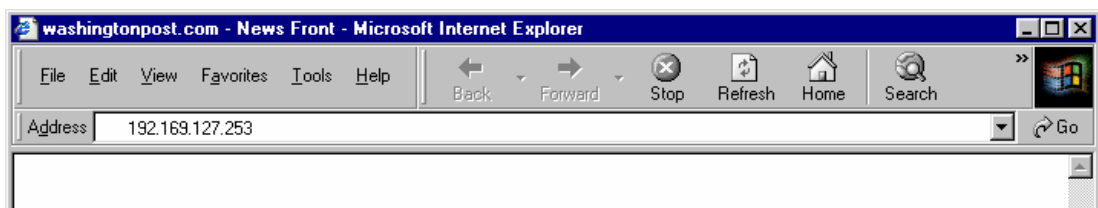

- The Moxa DSL Ethernet extender’s web console will open, and you will be prompted to log in. Select the login account (admin or user) and enter the **Password**. This password will be required to access any of the consoles (web, serial, Telnet). If you do not wish to create a password, leave the **Password** field blank and press **Enter**.

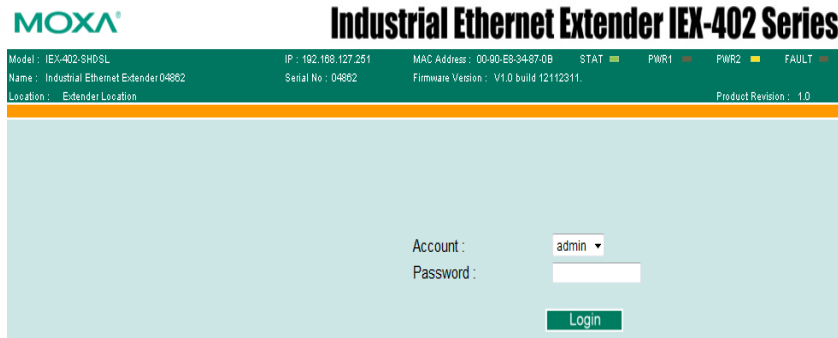

NOTE By default, no password is assigned to the Moxa DSL Ethernet extender’s web, serial, and Telnet consoles.

- After logging in, you may need to wait a few moments for the web console to appear. Use the folders in the left navigation panel to navigate between different pages of configuration options.

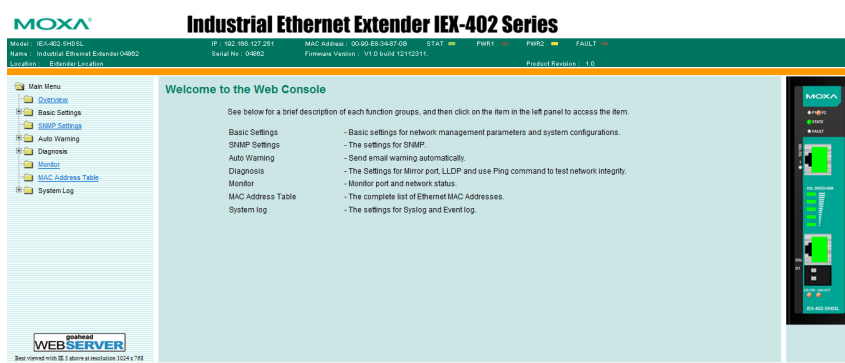

Disabling Telnet and Browser Access

If you are connecting the Moxa DSL Ethernet extender to a public network but do not intend to manage it over the network, we suggest disabling both the Telnet and web consoles. This is done from the serial console by navigating to **System Identification** under **Basic Settings**. Disable or enable the **Telnet Console** and **Web Configuration** as shown below:

```

MOXA EtherDevice Switch IEX-402-VDSL2
Basic Settings
[System] [Password] [Accessible IP] [Port] [Network] [Time] [Backup Media]
[Restart] [Factory default] [Upgrade] [Activate] [Main menu]

System Identification
ESC: Previous menu  Enter: Select  Space bar: Toggle

Switch Name          [Industrial Ethernet Extender 00002  ]
Switch Location      [Extender Location                    ]
Switch Description   [MOXA IEX-402-VDSL2                  ]
Maintainer Contact Info [                                       ]

Serial NO.           00001
Firmware Version     V1.0
MAC Address          00-00-00-00-00-01

Telnet Console       [Enable ]
Web Configuration    [http or https]
Web Auto-logout (s) [0      ]
Age-time (s)        [300   ]
    
```

Featured Functions

In this chapter, we explain how to access the Moxa DSL Ethernet extender's various configuration, monitoring, and administration functions. These functions can be accessed by serial, Telnet, or web console. The serial console can be used if you do not know the Moxa DSL Ethernet extender's IP address and requires that you connect the Moxa DSL Ethernet extender to a PC COM port. The Telnet and web consoles can be opened over an Ethernet LAN or the Internet.

The web console is the most user-friendly interface for configuring a Moxa DSL Ethernet extender. In this chapter, we use the web console interface to introduce the functions. There are only a few differences between the web console, serial console, and Telnet console.

The following topics are covered in this chapter:

▣ **Product Overview**

- Wiring the Devices
- Getting Started

Product Overview

MOXA's IEX series are entry-level managed DSL Ethernet extenders that allow you to extend the point-to-point Ethernet connections over DSL technology in a cost-effective way. With the IEX series, networks can be set up without additional fiber upgrades or reconstruction by leveraging existing copper wiring resources. Compliant with G.SHDSL.bis and VDSL2 standards, the IEX-402-SHDSL series supports data rates of up to 15.3 Mbps across distances of up to 8 km. The IEX-402-VDSL2 series fulfill high bandwidth requirements of up to 100 Mbps across distances of up to 3 km (transmission data rate depends on cable quality, environmental noise, and connection distance).

For simple installation, the following configuration steps allow you to effectively reduce deployment time, simplify maintenance, and enhance manageability.

Wiring the Devices

MOXA's IEX series have two ports. The upper port is a 10/100BaseT(x) port for connecting to an Ethernet-enabled device such as a switch or a PLC. The lower port is designed to connect both DSL extenders through a twisted-pair copper wire.

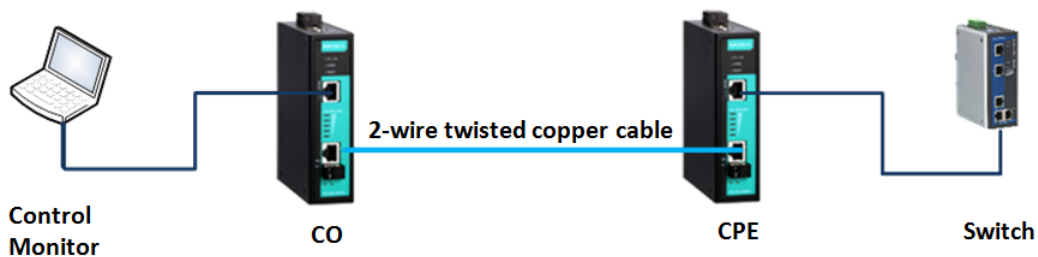

Getting Started

Step 1: DIP Switch Settings

Both extenders need to have the same DIP switch settings (except when manually configuring CO/CPE designations).

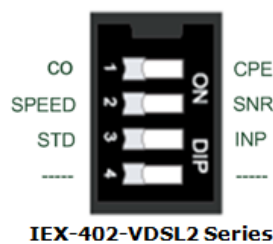
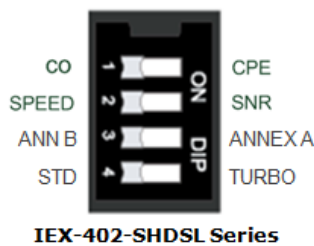

1st DIP switch: CO/CPE Assignment

The DSL Ethernet extenders need to work in pairs with one unit designated as a CO (central office) device and the other as a CPE (customer premise equipment) device. In addition to manual configuration by selecting the DIP switch settings (CO/CPE) on both devices, the IEX series can also perform automatic CO/CPE designation when both extenders are set as CO devices (all IEX series extenders are set as CO by default). The system will auto-negotiate to assign CPE to one of the devices in each connected pair and will decide the maximum transmission data rate based on line conditions.

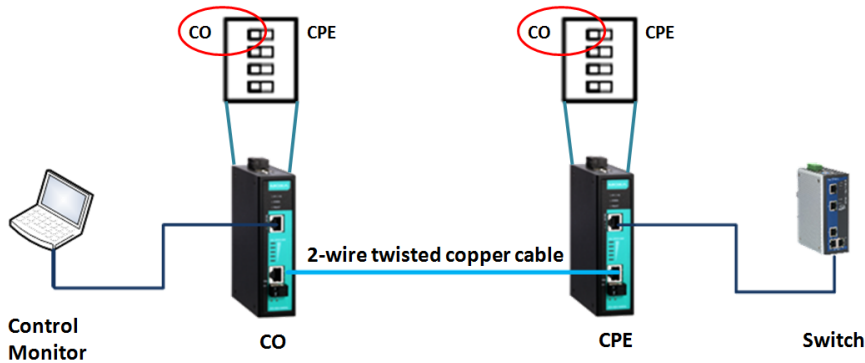

NOTE

- Time from device boot-up to connection-ready status: 70 seconds to 6 minutes, depending on line conditions.
- The DSL port is designed to be used on private communication lines for point-to-point connections only and is not able to be connected to the Public Switched Telephone Networks (PSTN).

NOTE

- For the IEX-402-SHDSL series, the Auto CO/CPE negotiation is only available under STD mode.
- The system-ready time with auto CO/CPE negotiation takes approximately 20 seconds to 3 minutes longer (depending on line conditions) than when manually pre-defining the devices (one as a CO and the other as a CPE device) using the with DIP switch settings.

2nd DIP Switch: SNR/Speed Display Information

The second DIP switch is used to select whether the transmission speed or the SNR (signal-to-noise ratio) is displayed on the DSL Speed/SNR LED indicator. More signal bars means higher DSL speed or SNR.

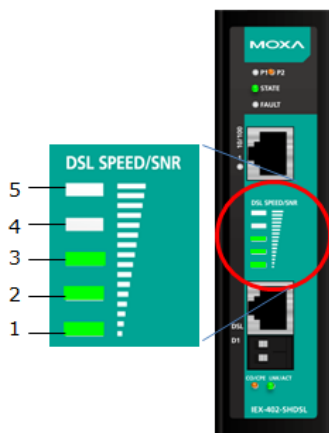

IEX-402-SHDSL Series

	Turbo Speed (K bits)	STD Speed (K bits)	SNR (dB)
5	10297 - 15304	4609 - 5760	18 - 30
4	5697 - 10296	3073 - 4608	14 - 17
3	3457 - 5696	2049 - 3072	10 - 13
2	1025 - 3456	769 - 2048	6 - 9
1	192 - 1024	192 - 768	3 - 5

IEX-402-VDSL2 Series

	Asymmetric TX Speed (Kbps)	Symmetric TX Speed (Kbps)	SNR (dB)
5	80001 - 100000	60001 - 100000	21-30
4	55001 - 80000	30001 - 60000	13-20
3	20001 - 55000	15001 - 30000	6-12
2	5001 - 20000	4001 - 15000	5
1	256 - 5000	256 - 4000	3-4

3rd DIP Switch: Annex A/Annex B Assignment (IEX-402-SHDSL Series Only)

Generally, DSL supports different band plans and modulations for transmission over POTS or ISDN. For point-to-point applications, the Annex A/Annex B selection refers to the cable type between DSL ports of both devices. If the cable is US-Type/0.5mm, please configure as ANNEX A. Otherwise, please set as default ANNEX B.

NOTE The DSL link can still to be established if the cable type and DIP switch settings do not match. However, there will be a slight performance difference of less than 100kbps at the same transmission distance.

4th DIP Switch:

STD/Turbo Speed Selection(IEX-402-SHDSL Series Only)

The IEX-402-SHDSL series supports 2 transmission speed settings; STD (standard) mode and TURBO mode. STD mode supports speeds from 192 kbps to 5696 kbps and the maximum speed supported by TURBO mode is 15.3 Mbps. The shorter the connection distance between DSL ports, the faster the transmission speed (not taking environmental noises into consideration). If Turbo mode is enabled, the unit will step through the different rates of speed until the best bit-rate is decided based on the line conditions. During the speed training process, the DSL connection will constantly disconnect and connect again. It takes less than 6 minutes to complete the training process.

NOTE

- TURBO mode supports higher transmission speeds when the DSL connection distance is less than 1.5 kilometers.
- Auto CO/CPE assignment is not valid when TURBO mode is enabled. Please manually assign one as a CO device and the other as a CPE device.
- Under Turbo mode, when DSL disconnects during a stable connection because of external factors (e.g., reduced SNR, cable unplugged and plugged in again), the system will try to re-establish the link and keep the connection speed less or equal to 5696 kbps in order to provide a stable transmission quality.

STD/INP Mode Selection (IEX-402-VDSL2 Series Only)

The IEX-402-VDSL2 supports two transmission modes; STD (standard) mode and INP (impulse noise protection) mode. STD mode means that data is transmitted directly between two connected points with 2 ms latency. INP mode is used for applications which can encounter frequent man-made or natural electromagnetic interference, e.g. communication equipment, electrical appliances, lightening discharges, etc. When INP mode is enabled, DSL communication is protected from impulse noise with a duration of less than 500 μ s and has a maximum end-to-end transmission latency of 8 ms.

NOTE For reliable DSL connections, the throughput of INP mode is 3 Mbps slower than STD mode.

Step2: Advanced Settings

The **Advanced Settings** section includes the most common settings required by administrators to maintain and control a Moxa DSL Ethernet extender.

System Identification

System Identification items are displayed at the top of the web console and will be included in alarm emails. You can configure the System Identification items to make it easier to identify different DSL Ethernet extenders that are connected to your network.

System Identification

Product Name	<input type="text" value="Industrial Ethernet Extender 0"/>
Product Location	<input type="text" value="Extender Location"/>
Product Description	<input type="text" value="MOXA IEX-402-SHDSL"/>
Maintainer Contact Info	<input type="text"/>
Web Configuration	<input type="text" value="http or https"/>
Web Auto-logout (s)	<input type="text" value="0"/>
Age Time (s)	<input type="text" value="300"/>
CPU Loading (past 5 seconds)	1 %
CPU Loading (past 30 seconds)	1 %
CPU Loading (past 5 minutes)	0 %
Free Memory	9202556 Bytes

DSL Ethernet Extender Name

Setting	Description	Factory Default
Max. 30 characters	This option is useful for differentiating between the roles or applications of different units. Example: Factory DSL Ethernet extender 1.	Industrial Ethernet DSL Ethernet extender [Serial no. of this DSL DSL Ethernet extender]

DSL Ethernet Extender Location

Setting	Description	Factory Default
Max. 80 characters	This option is useful for differentiating between the locations of different units. Example: production line 1.	DSL Ethernet extender Location

DSL Ethernet Extender Description

Setting	Description	Factory Default
Max. 30 characters	This option is useful for recording a more detailed description of the unit.	MOXA [Model name of this DSL DSL Ethernet extender]

Maintainer Contact Info

Setting	Description	Factory Default
Max. 30 characters	This option is useful for providing information about who is responsible for maintaining this unit and how to contact this person.	None

Web Auto-logout (S)

Setting	Description	Factory Default
60 to 86400 (seconds)	Disable or extend the auto-logout time for the web management console.	0 (disabled)

Age Time (S)

Setting	Description	Factory Default
15 to 3825 (seconds)	The length of time that a MAC address entry can remain in the Moxa DSL Ethernet extender. When an entry reaches its aging time, it "ages out" and is purged from the DSL Ethernet extender, effectively cancelling frame forwarding to that specific port.	300

CPU Loading

Setting	Description	Factory Default
Read-only	The CPU usage volume in the past 5 seconds, 30 seconds, and 5 minutes	None

Free Memory

Setting	Description	Factory Default
Read-only	The immediately free memory of the DSL Ethernet extender	None

Password

The Moxa DSL Ethernet extender provides two levels of configuration access. The **admin** account has read/write access of all configuration parameters, and the **user** account has read access only. A **user** account can view the configuration, but will not be able to make modifications.

**ATTENTION**

By default, a password is not assigned to the Moxa DSL Ethernet extender's web, Telnet, and serial consoles. If a password is assigned, you will be required to enter the password when you open the serial console, Telnet console, or web console.

Account

Setting	Description	Factory Default
Admin	This account can modify the Moxa DSL Ethernet extender's configuration.	admin
User	This account can only view the Moxa DSL Ethernet extender's configurations.	

Password

Setting	Description	Factory Default
Old password (max. 16 characters)	Enter the current password	None
New password (Max. 16 characters)	Enter the desired new password. Leave it blank if you want to remove the password.	None
Retype password (Max. 16 characters)	Enter the desired new password again. Leave it blank if you want to remove the password.	None

Accessible IP List

The Moxa DSL Ethernet extender uses an IP address-based filtering method to control access.

Accessible IP List

Enable the accessible IP list ("Disable" will allow all IP's connection)

Index	IP	NetMask
1	<input type="text"/>	<input type="text"/>
2	<input type="text"/>	<input type="text"/>
3	<input type="text"/>	<input type="text"/>
4	<input type="text"/>	<input type="text"/>
5	<input type="text"/>	<input type="text"/>
6	<input type="text"/>	<input type="text"/>
7	<input type="text"/>	<input type="text"/>
8	<input type="text"/>	<input type="text"/>
9	<input type="text"/>	<input type="text"/>
10	<input type="text"/>	<input type="text"/>

Activate

You may add or remove IP addresses to limit access to the Moxa DSL Ethernet extender. When the accessible IP list is enabled, only addresses on the list will be allowed access to the Moxa DSL Ethernet extender. Each IP address and netmask entry can be tailored for different situations:

- **Grant access to one host with a specific IP address**
For example, enter the IP address 192.168.1.1 with netmask 255.255.255.255 to allow access from 192.168.1.1 only.
- **Grant access to any host on a specific subnetwork**
For example, enter the IP address 192.168.1.0 with netmask 255.255.255.0 to allow access from all IPs on the subnet defined by this IP address/subnet mask combination.
- **Grant access to all hosts**
Make sure the accessible IP list is not enabled. Remove the checkmark from **Enable the accessible IP list**.

The following table shows additional configuration examples:

Hosts That Need Access	Input Format
Any host	Disable
192.168.1.120	192.168.1.120 / 255.255.255.255
192.168.1.1 to 192.168.1.254	192.168.1.0 / 255.255.255.0
192.168.0.1 to 192.168.255.254	192.168.0.0 / 255.255.0.0
192.168.1.1 to 192.168.1.126	192.168.1.0 / 255.255.255.128
192.168.1.129 to 192.168.1.254	192.168.1.128 / 255.255.255.128

Port Settings

Ethernet Port Settings

Port settings include port transmission speed, flow control, and port type (MDI or MDIX).

Port Settings
LAN Port Setting

Port	Description	Name	Speed	FDX Flow Ctrl	MDI/MDIX
1	100TX,RJ45	<input type="text"/>	Auto ▾	Disable ▾	Auto ▾

Description

Setting	Description	Factory Default
Media type	Displays the media type for each module's port	N/A

Name

Setting	Description	Factory Default
Max. 63 characters	Specifies an alias for the port to help administrators differentiate between different ports. Example: PLC 1	None

Speed

Setting	Description	Factory Default
Auto	Allows the port to use the IEEE 802.3u protocol to negotiate with connected devices. The port and connected devices will determine the best speed for that connection.	Auto
1G-Full	Choose one of these fixed speed options if the connected Ethernet device has trouble auto-negotiating for line speed.	
100M-Full		
100M-Half		
10M-Full		
10M-Half		

FDX Flow Ctrl

This setting enables or disables flow control for the port when the port Speed is set to Auto. The final result will be determined by the Auto process between the Moxa DSL Ethernet extender and connected devices.

Setting	Description	Factory Default
Enable	Enables flow control for this port when the port's Speed is set to Auto.	Disabled
Disable	Disables flow control for this port when the port's Speed is set to Auto.	

MDI/MDIX

Setting	Description	Factory Default
Auto	Allows the port to auto-detect the port type of the connected Ethernet device and change the port type accordingly.	Auto
MDI	Choose MDI or MDIX if the connected Ethernet device has trouble auto-negotiating for port type.	
MDIX		

DSL Port Settings

DSL port settings provide the interface to configure the port transmission speed

IEX-402-SHDSL Series

xDSL Port Setting							
Port	Description	Name	Mode (SET/ACT)	Turbo	Speed	Annex	LED Status
D1	G.SHDSL.bis	<input type="text"/>	CO/CO	Disable	Auto ▾	B (EU)	SNR

Description

Setting	Description	Factory Default
Standard	Display the standard of DSL port	G.SHDSL.bis

Name

Setting	Description	Factory Default
Max. 63 characters	Specifies an alias for the port to help administrators differentiate between different devices. Example: Site_A	None

Mode (SET/ACT)

Setting	Description	Factory Default
Device type	SET: The value same as CO/CPE DIP switch configuration ACT: The value after connected pairs negotiation	CO/CO or CPE after negotiation

Turbo

The IEX-402-SHDSL series support two communication modes; Standard (STD) and Turbo. The difference is the transmission data rate, highest up to 5.7Mbps and 15.3Mbps for standard and turbo mode respectively. The higher the transmission data rate, the shorter the connection distance. In other words, lower data rates can extend the transmission over a longer distance.

In standard mode, the connection speed is decided once the connection is established between the CO and the CPE based on line conditions, including distance, SNR (signal-to-noise ratio) and cable quality. However, the transmission speed of Turbo mode will be auto detected from 5696 Kbps to 15.3 Mbps gradually. It should take less than 7 minutes to complete the training process.

Setting	Description	Factory Default
Turbo mode status	Indicates whether turbo mode is enabled or not based on DIP switch configuration	Disabled

Speed

Transmission speed can only be configured while Turbo mode is disabled. It shows the list of configurable transmission speeds.

Setting	Description	Factory Default
Transmission speed	Auto: Allows the DSL ports to negotiate the best transmission speed based on line conditions. Fixed speed: Manually assigning one of these fixed speed options: 192K, 384K, 512K, 768K, 1024K, 1280K, 2048K, 2304K, 2688K, 3072K, 3456K, 4224K, 4608K, 4992K, 5376K, 5696K	Auto

NOTE Device will try to attain the set speed. If line condition degrades (reducing SNR) but the device is able to keep the link, the DSL SNR/SPEED LED is the indicator to notify user of the reduced SNR. However, if the line condition is too poor to maintain the link, the connection will be very unstable or disabled to re-establish connection, MOXA recommends manually assigning a lower transmission speed or to auto mode until the link is able to be established.

Annex

Description	Factory Default
Display the ANNEX A/ANNEX B DIP switch configuration	ANNEX B (EU)

LED Status

The DSL Ethernet extender can display two parameters types on the DSL SPEED/SNR LED indicator. One is the transmission speed and the other is the signal-to-noise ratio (SNR) of the connection. Selecting the hardware DIP switch on the DSL Ethernet extender determines what will be displayed for DSL SPEED/SNR LED indicator on device front panel.

Setting	Description	Factory Default
LED indicator status	Displays SPEED/SNR DIP switch configuration	SNR

IEX-402-VDSL2 Series

xDSL Port Setting

Port	Description	Name	CO/CPE Mode (SET/ACT)	Rate Control	Speed (DS/US)	INP	Speed/SNR Status
D1	VDSL2	<input type="text"/>	CO/CO	Asymmetric ▾	Auto ▾	Disabled	SPEED

Description

Setting	Description	Factory Default
Standard	Display the standard of DSL port	VDSL2

Name

Setting	Description	Factory Default
Max. 63 characters	Specifies an alias for the port to help administrators differentiate between different devices. Example: Site_A	None

CO/CPE Mode (SET/ACT)

Setting	Description	Factory Default
Device type	SET: The value same as CO/CPE DIP switch configuration ACT: The value after connected pairs negotiation	CO/CO or CO/CPE after negotiation

Rate Control

Data flow from CO to CPE is designated as downstream while upstream is defined as data flow from CPE to CO.

Setting	Description	Factory Default
Downstream and upstream transmission rate	Asymmetric: downstream rate is higher than upstream rate. Symmetric: downstream rate is similar to upstream rate. Asymmetric can provide a longer transmission distance than symmetric.	Asymmetric

Speed (DS/US)

For the IEX-402-VDSL2 series, the CO device dictates the line configuration settings to the CPE device. Therefore, please change the speed setting on the CO device.

Setting	Description	Factory Default
Transmission speed	Auto: Allows the DSL ports to negotiate the best transmission speed based on line conditions. Fixed Speed: Manually assigning one of these fixed speed options. <ul style="list-style-type: none"> • Asymmetric speed: <ul style="list-style-type: none"> 100M/100M, 100M/70M, 80M/50M, 60M/30M, 55/15M, 50M/8M, 40M/5M, 30M/2.5M, 20M/1.5M, 10M/1M, 8M/1M, 5M/768K, 3M/512K, 1M/256K 	Auto

	<ul style="list-style-type: none"> Symmetric speed: 100M/100M, 75M/75M, 60M/60M, 40M/40M, 30M/30M, 25M/25M, 20M/20M, 15M/15M, 10M/10M, 5M/5M, 4M/4M, 3M/3M, 2M/2M, 1M/1M 	
--	---	--

NOTE Device will try to attain the set speed. If line condition degrades (reducing SNR) but the device is able to maintain the link, the DSL SNR/SPEED LED is the indicator to notify user of the reduced SNR. However, if the line condition is too poor to maintain the link, the connected pairs will try to maintain the speed at 256 kbps under acceptable line conditions. Users can check the actual connection speed from 'Monitor page'. If the speed is set to 256 kbps, it means that the fixed speed can't be maintained based on the line conditions.

INP

The IEX-402-VDSL2 series supports two communication modes; STD (standard) and INP (impulse noise protection). Both are configured by DIP switch.

According to the ITU-993.2 standard, INP is an error correction algorithm as the number of consecutive DMT symbols or fractions, as seen at the input to the de-interleaver, for which errors can be completely corrected by the error correcting code.

In STD (standard) mode, the packet will be directly transmitted with latency under 2 ms while INP mode has under 8 ms transmission latency with 500 μ s interleave DMT.

Setting	Description	Factory Default
INP mode status	Indicates whether INP mode is enabled or disabled based on DIP switch configuration	Disabled

SPEED/SNR Status

The IEX-402-VDSL2 series supports two parameters displayed on the DSL SPEED/SNR LED indicator. One is transmission speed and the other is the signal-to-noise ratio (SNR) of the connection. By selecting the hardware DIP switch, SNR/SPEED reflects what will be displayed for DSL SPEED/SNR LED indicator on device front panel.

Setting	Description	Factory Default
LED indicator status	Displays SPEED/SNR DIP switch configuration	SPEED

Link Fault Pass-Through

If the Ethernet or DSL connection is down, the device will not be notified that the connection has been terminated. The device will continue to transmit packets and wait idly for a response that never arrives—and the longer the wait, the higher the possibility that packets will be lost.

With link fault pass through (LFP), a troubleshooting function that drastically reduces the waiting time, enables Moxa IEX series products to force Ethernet link down to prevent data loss.



Ethernet Link-Down Mode

If either the CO or CPE Ethernet link is down, the IEX series will disable the corresponding Ethernet connection so that data can no longer be sent but keeps the DSL connection alive. As a result, Ethernet-enabled devices such as the switch or end devices connected to the DSL Ethernet extenders will be notified about the failed connection. Once the Ethernet link is up again, the IEX series will try to fast recover the connection without DSL re-training. The system logs will record link up/down events.

DSL Link-Down Mode

When the DSL connection is down, the IEX series will immediately disable both CO and CPE Ethernet connections to avoid packets being sent through the failed path. The IEX series will try to re-establish the Ethernet link when the DSL connection is stable again. The system logs will record link up/down events.

Network Parameters

Network configuration allows users to configure both IPv4 and IPv6 parameters for management access over the network. The Moxa DSL Ethernet extender supports both IPv4 and IPv6, and can be managed through either of these address types.

A brief explanation of each configuration item is given below.

The screenshot shows the 'Network Parameters' configuration page. Under 'General Settings', there are two sections: IPv4 and IPv6. The IPv4 section includes a dropdown for 'Auto IP Configuration' (set to 'Disable'), and input fields for 'IP Address' (192.168.127.253), 'Subnet Mask' (255.255.255.0), 'Default Gateway', '1st DNS Server IP Address', and '2nd DNS Server IP Address'. The IPv6 section includes input fields for 'Global Unicast Address Prefix', 'Global Unicast Address', and 'Link-Local Address' (fe80::290:e8ff:fed1:212). An 'Activate' button is located at the bottom right.

IPv4

The IPv4 settings include the DSL Ethernet extender's IP address and subnet mask, as well as the IP address of the default gateway. In addition, input cells are provided for the IP addresses of a 1st and 2nd DNS server.

Auto IP Configuration

Setting	Description	Factory Default
Disable	The Moxa DSL Ethernet extender's IP address must be set manually.	Disable
By DHCP	The Moxa DSL Ethernet extender's IP address will be assigned automatically by the network's DHCP server.	
By BootP	The Moxa DSL Ethernet extender's IP address will be assigned automatically by the network's BootP server.	

DSL Ethernet Extender IP Address

Setting	Description	Factory Default
IP address for the Moxa DSL Ethernet extender	Assigns the Moxa DSL Ethernet extender's IP address on a TCP/IP network.	192.168.127.253

DSL Ethernet Extender Subnet Mask

Setting	Description	Factory Default
Subnet mask for the Moxa DSL Ethernet extender	Identifies the type of network the Moxa DSL Ethernet extender is connected to (e.g., 255.255.0.0 for a Class B network, or 255.255.255.0 for a Class C network).	255.255.255.0

Default Gateway

Setting	Description	Factory Default
IP address for gateway	Specifies the IP address of the router that connects the LAN to an outside network.	None

DNS IP Address

Setting	Description	Factory Default
IP address for DNS server	Specifies the IP address of the DNS server used by your network. After specifying the DNS server IP address, you can use the Moxa DSL Ethernet extender's URL (e.g., www.PT.company.com) to open the web console, instead of entering the IP address.	None
IP address for 2nd DNS server	Specifies the IP address of the secondary DNS server used by your network. The Moxa DSL Ethernet extender will use the secondary DNS server if the first DNS server fails to connect.	None

DHCP Retry Periods

Setting	Description	Factory Default
1 to 30	Users can configure the DHCP retry period manually	1

***Only valid for IEX-402-VDSL2 Series**

DHCP Retry Times

Setting	Description	Factory Default
0 to 65535	Users can manually configure the number of DHCP retries	0

***Only valid for IEX-402-VDSL2 Series**

IP6

The IPv6 settings include two distinct address types—Link-Local Unicast addresses and Global Unicast addresses. A Link-Local address makes the DSL Ethernet extender accessible over IPv6 for all devices attached to the same local subnet. To connect to a larger network with multiple segments, the DSL Ethernet extender must be configured with a Global Unicast address.

Global Unicast Address Prefix (Prefix Length: 64 bits) Default Gateway

Setting	Description	Factory Default
Global Unicast Address Prefix	The prefix value must be formatted according to the RFC 2373 "IPv6 Addressing Architecture," using 8 colon-separated 16-bit hexadecimal values. One double colon may be used in the address to indicate the appropriate number of zeros required to fill the undefined fields.	None

Global Unicast Address

Setting	Description	Factory Default
None	Displays the IPv6 Global Unicast address. The network portion of the Global Unicast address can be configured by specifying the Global Unicast Prefix and using an EUI-64 interface ID in the low order 64 bits. The host portion of the Global Unicast address is automatically generated using the modified EUI-64 form of the interface identifier (DSL Ethernet extender's MAC address).	None

Link-Local Address

Setting	Description	Factory Default
None	The network portion of the Link-Local address is FE80 and the host portion of the Link-Local address is automatically generated using the modified EUI-64 form of the interface identifier (DSL Ethernet extender’s MAC address)	None

Neighbor Cache

IPv6 Address	Link Layer (MAC) Address	State
fe80::290:e8ff:fed1:212	00-90-e8-d1-02-12	Reachable

Neighbor Cache

Setting	Description	Factory Default
None	The information in the neighbor cache that includes the neighboring node’s IPv6 address, the corresponding Link-Layer address, and the current state of the entry.	None

System Time Settings

System Time Settings

Current Time: -- : -- : -- (ex: 04:00:04)

Current Date: --- / -- / -- (ex: 2002/11/13)

Daylight Saving Time: Month Week Day Hour

Start Date: -- -- -- --

End Date: -- -- -- --

Offset: 0 hour(s)

Activate

System Up Time: 0d0h37m57s

Time Zone: (GMT)Greenwich Mean Time: Dublin, Edinburgh, Lisbon, London

1st Time Server IP/Name: time.nist.gov

2nd Time Server IP/Name:

Activate

The Moxa DSL Ethernet extender has a time calibration function based on information from an NTP server or user specified time and date. Functions such as automatic warning emails can therefore include time and date stamp.

NOTE The Moxa DSL Ethernet extender does not have a real time clock. The user must update the Current Time and Current Date to set the initial time for the Moxa DSL Ethernet extender after each reboot, especially when there is no NTP server on the LAN or Internet connection.

Current Time

Setting	Description	Factory Default
User-specified time	Allows configuration of the local time in local 24-hour format.	None

Current Date

Setting	Description	Factory Default
User-specified date	Allows configuration of the local date in yyyy-mm-dd format.	None

Daylight Saving Time

The Daylight Saving Time settings are used to automatically set the Moxa DSL Ethernet extender's time forward according to national standards.

Start Date

Setting	Description	Factory Default
User-specified date	Specifies the date that Daylight Saving Time begins.	None

End Date

Setting	Description	Factory Default
User-specified date	Specifies the date that Daylight Saving Time ends.	None

Offset

Setting	Description	Factory Default
User-specified hour	Specifies the number of hours that the time should be set forward during Daylight Saving Time.	None

System Up-Time

Indicates how long the Moxa DSL Ethernet extender remained up since the last cold start. The up time is indicated in seconds.

Time Zone

Setting	Description	Factory Default
Time zone	Specifies the time zone, which is used to determine the local time offset from GMT (Greenwich Mean Time).	GMT (Greenwich Mean Time)

NOTE Changing the time zone will automatically correct the current time. Be sure to set the time zone before setting the time.

Time Server IP/Name

Setting	Description	Factory Default
IP address or name of time server	The IP or domain address (e.g., 192.168.1.1, time.stdtime.gov.tw, or time.nist.gov).	None
IP address or name of secondary time server	The Moxa DSL Ethernet extender will try to locate the secondary NTP server if the first NTP server fails to connect.	

System File Update

Update System Files by Remote TFTP

The Moxa DSL Ethernet extender supports saving your configuration or log file to a remote TFTP server or local host. Other Moxa DSL Ethernet extenders can also load the configuration at a later time. The Moxa DSL Ethernet extender also supports loading firmware or configuration files from the TFTP server or a local host.

TFTP Server IP/Name

Setting	Description	Factory Default
IP address of TFTP server	Specifies the IP address or name of the remote TFTP server. Must be specified before downloading or uploading files.	None

Configuration Files Path and Name

Setting	Description	Factory Default
Max. 40 characters	Specifies the path and file name of the Moxa DSL Ethernet extender’s configuration file on the TFTP server.	None

Firmware Files Path and Name

Setting	Description	Factory Default
Max. 40 characters	Specifies the path and file name of the Moxa DSL Ethernet extender’s firmware file.	None

Log Files Path and Name

Setting	Description	Factory Default
Max. 40 characters	Specifies the path and file name of the Moxa DSL Ethernet extender’s log file.	None

After setting the desired paths and file names, click **Download** to download the prepared file from the remote TFTP server, or click **Upload** to upload the desired file to the remote TFTP server.

Update System Files from Local PC

Configuration File

Click **Export** to save the Moxa DSL Ethernet extender’s configuration file to the local host.

Log File

Click **Export** to save the Moxa DSL Ethernet extender’s log file to the local host.

NOTE Some operating systems will open the configuration file and log file directly in the web page. In such cases, right click the Export button to save the file.

Upgrade Firmware

To import a new firmware file into the Moxa DSL Ethernet extender, click **Browse** to select the firmware file that is saved on your computer. The upgrade procedure will proceed automatically after clicking **Import**.

Upload Configure Data

To import a configuration file into the Moxa DSL Ethernet extender, click **Browse** to select the configuration file already saved on your computer. The upgrade procedure will proceed automatically after clicking **Import**.

ABC (Auto-Backup Configurator) Configuration

You can use Moxa's Automatic Backup Configurator to save and load the Moxa DSL Ethernet extender's configurations through the DSL Ethernet extender's RS-232 console port.

ABC (Auto-Backup Configurator) Configuration

Auto load ABC's system configurations when system boots up Activate

Save the current configurations to ABC Save

Load the ABC's configurations to Switch Load

Restart

This function provides users with a quick way to restart the system.

Restart

This function will restart the system.

Activate

Reset to Factory Default

Reset to Factory Default

This function will reset all settings to their factory default values.
Be aware that previous settings will be lost.

Activate

This function provides users with a quick way of restoring the Moxa DSL Ethernet extender's configuration to factory defaults. The function is available in the serial, Telnet, and web consoles.

NOTE After restoring the factory default configuration, you will need to use the default network settings to re-establish the web or Telnet console connection with the Moxa DSL Ethernet extender.

Configuring SNMP

The Moxa DSL Ethernet extender supports SNMP V1, V2c, and V3. SNMP V1 and SNMP V2c use a community string match for authentication, which means that SNMP servers access all objects with read-only or read/write permissions using the community strings *public* and *private* by default. SNMP V3 requires that you select an authentication level of MD5 or SHA, and is the most secure protocol. You can also enable data encryption to enhance data security.

Supported SNMP security modes and levels are shown in the following table. Select the security mode and level that will be used to communicate between the SNMP agent and manager.

Protocol Version	UI Setting	Authentication	Encryption	Method
SNMP V1, V2c	V1, V2c Read Community	Community string	No	Uses a community string match for authentication.
	V1, V2c Write/Read Community	Community string	No	Uses a community string match for authentication.
SNMP V3	No-Auth	No	No	Uses an account with admin or user to access objects
	MD5 or SHA	Authentication based on MD5 or SHA	No	Provides authentication based on HMAC-MD5, or HMAC-SHA algorithms. 8-character passwords are the minimum requirement for authentication.
	MD5 or SHA	Authentication based on MD5 or SHA	Data encryption key	Provides authentication based on HMAC-MD5 or HMAC-SHA algorithms, and data encryption key. 8-character passwords and a data encryption key are the minimum requirements for authentication and encryption.

These parameters are configured on the SNMP page. A more detailed explanation of each parameter is given below the figure.

SNMP

SNMP Read/Write Settings

SNMP Versions V1, V2c ▾

V1,V2c Read Community

V1,V2c Write/Read Community

Admin Auth. Type No-Auth ▾

Admin Data Encryption Key

User Auth. Type No-Auth ▾

User Data Encryption Key

Trap Settings

1st Trap Server IP/Name

1st Trap Community

2nd Trap Server IP/Name

2nd Trap Community

Trap Mode

Trap ▾

Retries (1~99)

Timeout (1~300s)

Private MIB information

Switch Object ID enterprise.8691.7.17

SNMP Read/Write Settings

SNMP Versions

Setting	Description	Factory Default
V1, V2c, V3, or V1, V2c, or V3 only	Specifies the SNMP protocol version used to manage the DSL Ethernet extender.	V1, V2c

V1, V2c Read Community

Setting	Description	Factory Default
Max. 30 characters	Specifies the community string to authenticate the SNMP agent for read-only access. The SNMP agent will access all objects with read-only permissions using this community string.	Public

V1, V2c Write/Read Community

Setting	Description	Factory Default
Max. 30 characters	Specifies the community string to authenticate the SNMP agent for read/write access. The SNMP server will access all objects with read/write permissions using this community string.	Private

For SNMP V3, two levels of privilege are available accessing the Moxa DSL Ethernet extender. **Admin** privilege provides access and authorization to read and write the MIB file. **User** privilege allows reading of the MIB file only.

Admin Auth. Type (for SNMP V1, V2c, V3, and V3 only)

Setting	Description	Factory Default
No-Auth	Allows the admin account to access objects without authentication.	No
MD5-Auth	Authentication will be based on the HMAC-MD5 algorithms. 8-character passwords are the minimum requirement for authentication.	No
SHA-Auth	Authentication will be based on the HMAC-SHA algorithms. 8-character passwords are the minimum requirement for authentication.	No

Admin Data Encryption Key (for SNMP V1, V2c, V3, and V3 only)

Setting	Description	Factory Default
Enable	Enables data encryption using the specified data encryption key (between 8 and 30 characters).	No
Disable	Specifies that data will not be encrypted.	No

User Auth. Type (for SNMP V1, V2c, V3 and V3 only)

Setting	Description	Factory Default
No-Auth	Allows the admin account and user account to access objects without authentication.	No
MD5-Auth	Authentication will be based on the HMAC-MD5 algorithms. 8-character passwords are the minimum requirement for authentication.	No
SHA-Auth	Authentication will be based on the HMAC-SHA algorithms. 8-character passwords are the minimum requirement for authentication.	No

User Data Encryption Key (for SNMP V1, V2c, V3 and V3 only)

Setting	Description	Factory Default
Enable	Enables data encryption using the specified data encryption key (between 8 and 30 characters).	No
Disable	No data encryption	No

Trap Settings

SNMP traps allow an SNMP agent to notify the NMS of a significant event. The DSL Ethernet extender supports two SNMP modes, **Trap** mode and **Inform** mode.

SNMP Trap Mode—Trap

In Trap mode, the SNMP agent sends a SNMPv1 trap PDU to the NMS. No acknowledgment is sent back from the NMS so the agent has no way of knowing if the trap reached the NMS.

Trap Mode

Trap ▼

Retries (1~99)

Timeout (1~300s)

SNMP Trap Mode—Inform

SNMPv2 provides an inform mechanism. When an inform message is sent from the SNMP agent to the NMS, the receiver sends a response to the sender acknowledging receipt of the event. This behavior is similar to that of the get and set requests. If the SNMP agent does not receive a response from the NMS for a period of time, the agent will resend the trap to the NMS agent. The maximum timeout time is 300 sec (default is 10 sec), and the maximum number of retries is 99 times (default is 3 time). When the SNMP agent receives acknowledgement from the NMS, it will stop resending the inform messages.

Trap Mode

Inform ▼

Retries (1~99)

Timeout (1~300s)

1st Trap Server IP/Name

Setting	Description	Factory Default
IP or name	Specifies the IP address or name of the primary trap server used by your network.	None

1st Trap Community

Setting	Description	Factory Default
Max. 30 characters	Specifies the community string to use for authentication.	Public

2nd Trap Server IP/Name

Setting	Description	Factory Default
IP or name	Specifies the IP address or name of the secondary trap server used by your network.	None

2nd Trap Community

Setting	Description	Factory Default
Max. 30 characters	Specifies the community string to use for authentication.	Public

Private MIB Information

DSL Ethernet extender Object ID

Setting	Description	Factory Default
Specific Moxa DSL Ethernet extender ID	Indicates the Moxa DSL Ethernet extender's enterprise value.	Depends on DSL Ethernet extender model type

NOTE: The DSL Ethernet extender Object ID cannot be changed.

Using Auto Warning

Since industrial Ethernet devices are often located at the endpoints of a system, these devices will not always know what is happening elsewhere on the network. This means that an industrial DSL Ethernet extender that connects to these devices must provide system maintainers with real-time alarm messages. Even when control engineers are out of the control room for an extended period of time, they can still be informed of the status of devices almost instantaneously when exceptions occur. The MOXA DSL Ethernet extender supports system warning by email with the event triggered.

Configuring Email Warning

The Auto Email Warning function uses e-mail to alert the user when certain user-configured events take place. Three basic steps are required to set up the Auto Warning function:

Configure Email Event Types

Select the desired **Event types** from the Console or Web Browser Event type page (a description of each event type is given later in the *Email Alarm Events setting* subsection).

Configure Email Settings

To configure a Moxa DSL Ethernet extender's email setup from the serial, Telnet, or web console, enter your Mail Server IP/Name (IP address or name), Account Name, Account Password, Retype New Password, and the email address to which warning messages will be sent.

Activate your settings and if necessary, test the email

After configuring and activating your Moxa DSL Ethernet extender's Event Types and Email Setup, you can use the **Test Email** function to see if your e-mail addresses and mail server address have been properly configured.

Configuring Event Types

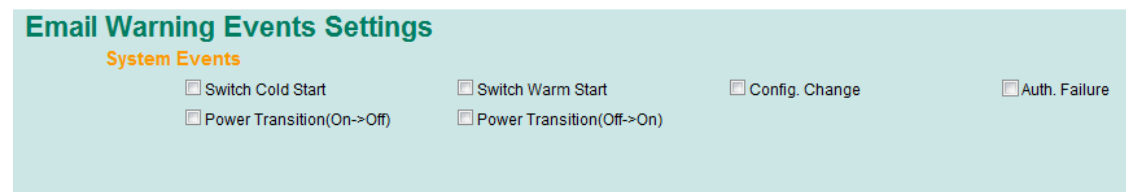

System Events	Warning e-mail is sent when...
DSL Ethernet extender Cold Start	Power is cut off and then reconnected.
DSL Ethernet extender Warm Start	Moxa DSL Ethernet extender is rebooted, such as when network parameters are changed (IP address, subnet mask, etc.).
Power Transition (On→Off)	Moxa DSL Ethernet extender is powered down.
Power Transition (Off→On)	Moxa DSL Ethernet extender is powered up.
Configuration Change Activated	Any configuration item has been changed.
Authentication Failure	An incorrect password was entered.

NOTE The sender of warning e-mail messages will have the following form:

Managed-DSL Ethernet extender-00000@DSL Ethernet extender_Location

Where Managed-DSL Ethernet extender-00000 is the default DSL Ethernet extender Name, 00000 is the Moxa DSL Ethernet extender's serial number and DSL Ethernet extender_Location is the default Server Location. Refer to the Basic Settings section to see how to modify DSL Ethernet extender Name and DSL Ethernet extender Location.

Configuring Email Settings

Email Warning Events Settings

Mail Server IP/Name:

SMTP Port:

Account Name :

Account Password :

Change Account Password

Old Password :

New Password :

Retype Password :

1st email address :

2nd email address :

3rd email address :

4th email address :

Mail Server IP/Name

Setting	Description	Factory Default
IP address	The IP Address of your email server.	None

SMTP Port

Setting	Description	Factory Default
SMTP port	Display the SMTP port number	25

Account Name

Setting	Description	Factory Default
Max. 45 of charters	Your email account.	None

Password Setting

Setting	Description	Factory Default
Disable/Enable to change password	To reset the password from the Web Browser interface, click the Change password check-box, type the Old password, type the New password, retype the New password, and then click Activate (Max. of 45 characters).	Disable
Old password	Type the current password when changing the password	None
New password	Type new password when enabled to change password; Max. 45 characters.	None
Retype password	If you type a new password in the Password field, you will be required to retype the password in the Retype new password field before updating the new password.	None

Email Address

Setting	Description	Factory Default
Max. of 30 characters	You can set up to 4 email addresses to receive alarm emails from the Moxa DSL Ethernet extender.	None

Send Test Email

After you complete the email settings, you should first click **Activate** to activate those settings, and then press the **Send Test Email** button to verify that the settings are correct.

NOTE Auto warning e-mail messages will be sent through an authentication protected SMTP server that supports the CRAM-MD5, LOGIN, and PAIN methods of SASL (Simple Authentication and Security Layer) authentication mechanism.

We strongly recommend not entering your Account Name and Account Password if auto warning e-mail messages can be delivered without using an authentication mechanism.

Using Diagnostics

The Moxa DSL Ethernet extender provides three important tools for administrators to diagnose network systems.

Ping

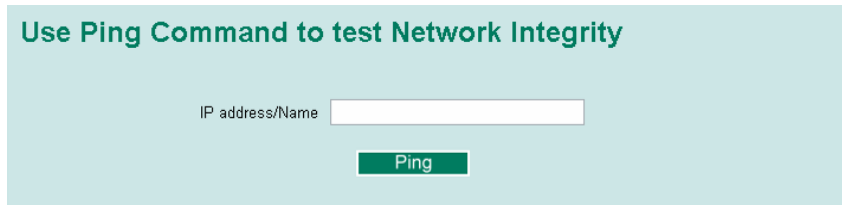

The **Ping** function uses the *ping* command to give users a simple but powerful tool for troubleshooting network problems. The function's most unique feature is that even though the ping command is entered from the user's PC keyboard, the actual ping command originates from the Moxa DSL Ethernet extender itself. In this way, the user can essentially sit on top of the Moxa DSL Ethernet extender and send ping commands out through its ports.

To use the Ping function, type in the desired IP address, and then press **Enter** from the Console utility, or click **Ping** when using the Web Browser interface.

LLDP Function

Overview

LLDP is an OSI Layer 2 protocol defined by IEEE 802.11AB. LLDP standardizes the self-identification advertisement method, and allows each networking device, such as a Moxa managed DSL Ethernet extender, to periodically send its system and configuration information to its neighbors. Because of this, all LLDP devices are kept informed of each other’s status and configuration, and with SNMP, this information can be transferred to Moxa’s MXview for auto-topology and network visualization.

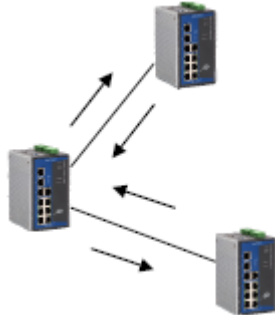

From the DSL Ethernet extender’s web interface, you can enable or disable LLDP, and set the LLDP transmit interval. In addition, you can view each DSL Ethernet extender’s neighbor-list, which is reported by its network neighbors. Most importantly, enabling the LLDP function allows Moxa’s MXview to automatically display the network’s topology and system setup details, such as VLAN and Trunking, for the entire network.

Configuring LLDP Settings

LLDP Settings
General Settings

LLDP Enable ▾
 Message Transmit Interval (5~32768secs)
Activate

LLDP Table

Port	Neighbor ID	Neighbor Port	Neighbor Port Description	Neighbor System
2	00:90:e8:34:87:22	2	G.SHDSL.bis	Industrial Ethernet Extender 04885

General Settings

LLDP

Setting	Description	Factory Default
Enable or Disable	Enables or disables the LLDP function.	Enable

Message Transmit Interval

Setting	Description	Factory Default
5 to 32768 sec.	Sets the transmit interval of LLDP messages, in seconds.	30 (seconds)

LLDP Table

The LLDP Table displays the following information:

Port	The port number that connects to the neighbor device.
Neighbor ID	A unique entity (typically the MAC address) that identifies a neighbor device.
Neighbor Port	The port number of the neighbor device.
Neighbor Port Description	A textual description of the neighbor device’s interface.
Neighbor System	Hostname of the neighbor device.

Using Monitor

You can monitor statistics in real time from the Moxa DSL Ethernet extender’s web console and serial console.

Monitor by DSL Ethernet extender

Access the Monitor by selecting **System** from the left selection bar. Monitor by System allows the user to view a graph that shows the combined data transmission activity of all of the Moxa DSL Ethernet extender’s 18 ports. Click one of the four options—**Total Packets**, **TX Packets**, **RX Packets**, or **Error Packets**—to view transmission activity of specific types of packets. Recall that TX Packets are packets sent out from the Moxa DSL Ethernet extender, RX Packets are packets received from connected devices, and Error Packets are packets that did not pass TCP/IP’s error checking algorithm. The Total Packets option displays a graph that combines TX, RX, and TX Error, RX Error Packets activity. The graph displays data transmission activity by showing **Packets/s** (i.e., packets per second, or pps) versus **sec.** (seconds). In fact, three curves are displayed on the same graph: **Uni-cast** packets (in red color), **Multi-cast** packets (in green color), and **Broad-cast** packets (in blue color). The graph is updated every few seconds, allowing the user to analyze data transmission activity in real-time.

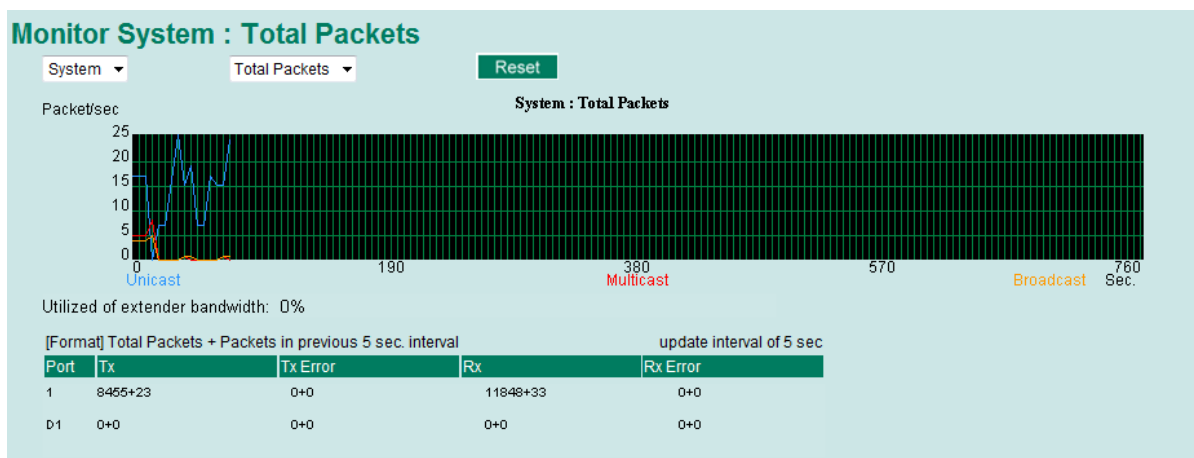

Monitor by DSL Port (D1)

Access the Monitor by selecting D1 from the pull-down list. By selecting this, users can view graphs that show all Packets, TX Packets, RX Packets, or Error Packets activity. The height of the bar represents Packets/s for the type of packet. That is, as time progresses, the height of the bar moves up or down so that the user can view the change in the rate of packet transmission. The blue colored bar shows Uni-cast packets, the red colored bar shows Multi-cast packets, and the orange colored bar shows Broad-cast packets. The graph is updated every few seconds, allowing the user to analyze data transmission activity in real-time. The table shows below the graph chart displays the actual link status, data rate, SNR (signal-to-noise ratio) and terminal type (CO/CPE) after negotiation.

IEX-402-SHDSL Series

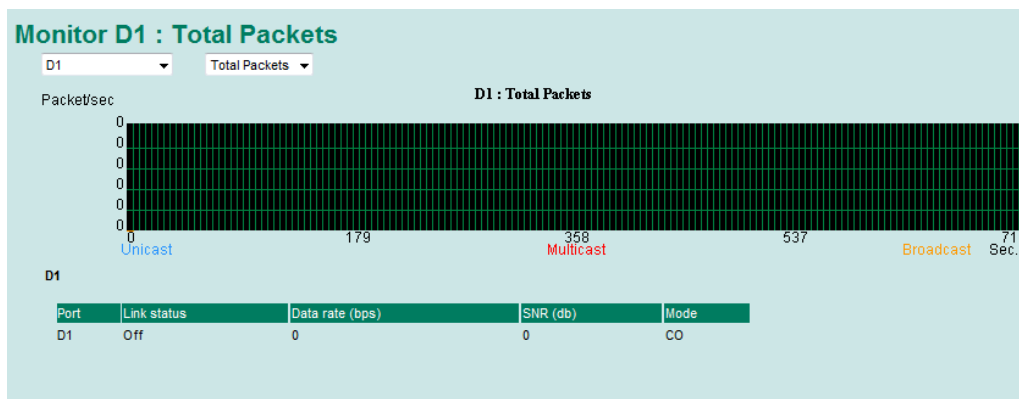

IEX-402-VDSL2 Series

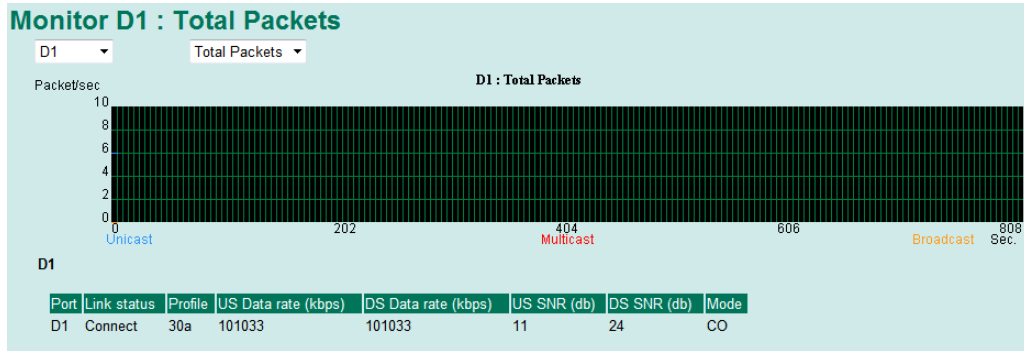

Using the MAC Address Table

This section explains the information provided by the Moxa DSL Ethernet extender’s MAC address table.

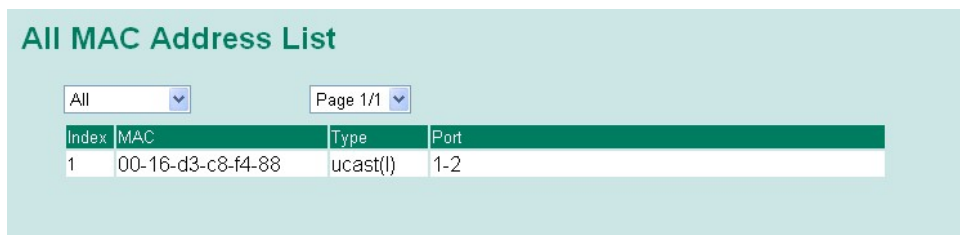

The MAC Address table can be configured to display the following Moxa DSL Ethernet extender MAC address groups, which are selected from the drop-down list:

ALL	Select this item to show all of the Moxa DSL Ethernet extender’s MAC addresses.
ALL Learned	Select this item to show all of the Moxa DSL Ethernet extender’s Learned MAC addresses.
ALL Static Lock	Select this item to show all of the Moxa DSL Ethernet extender’s Static Lock MAC addresses.
Port x	Select this item to show all of the MAC addresses dedicated ports.

The table displays the following information:

MAC	This field shows the MAC address.
Type	This field shows the type of this MAC address.
Port	This field shows the port that this MAC address belongs to.

4

Diagnostics, Management, and Performance

The following topics are covered in this chapter:

- ❑ **On-site Troubleshooting**
- ❑ **Remote Management**
- ❑ **Performance**

On-site Troubleshooting

The LED indicators of IEX series provides complete system and link status for quick on-site troubleshooting. When the system boots up, the connected pairs will start the CO/CPE detection before negotiating the connection speed over the DSL link. The CO/CPE LEDs will alternate colors (between green and amber) until both devices have finalized the setting. Then the devices will determine the best transmission rate and the LINK/ACT LED will blink slowly. After the training process is complete, the SPEED/SNR LED will indicate the connection quality of DSL link. Fewer bars on the LED display means a poor SNR or low connection speed. The device will try to maintain a speed for best transmission quality.

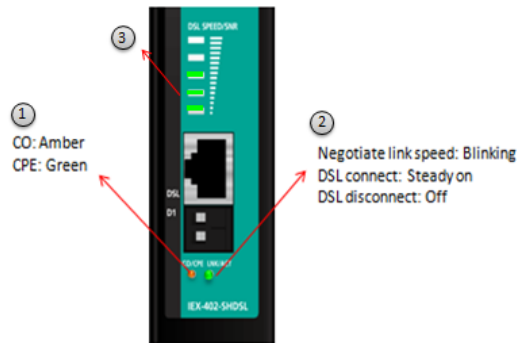

NOTE If the DSL link can't be finalized within 7 minutes, please check line conditions and configurations: e.g. distance, speed setting, environmental noises, etc.

The IEX series is designed for point-to-point Ethernet transmission over a DSL link. The connection distance between connected pairs can be many kilometers and on-site troubleshooting can be difficult to perform with insufficient visual information. The STATE LED helps to indicate the location of segment failure, allowing network operators to immediately determine the location and quickly recover from a link failure

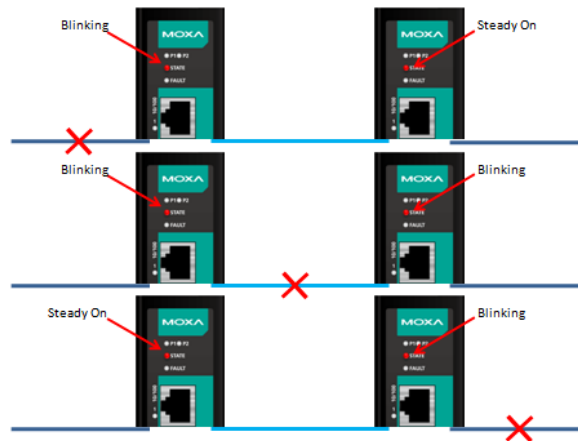

Remote Management

The virtual panel in the web-based browser and SNMP protocols allows the IEX series to be remotely managed at a glance and allows the devices to be managed by Moxa's MXview network management software for total network manageability.

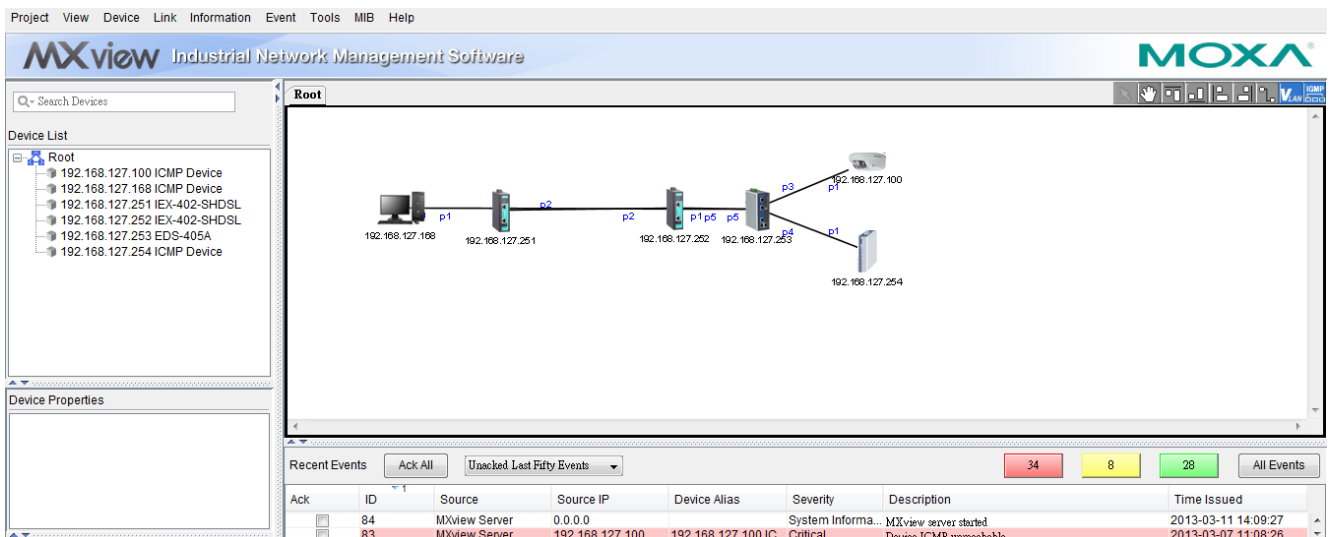
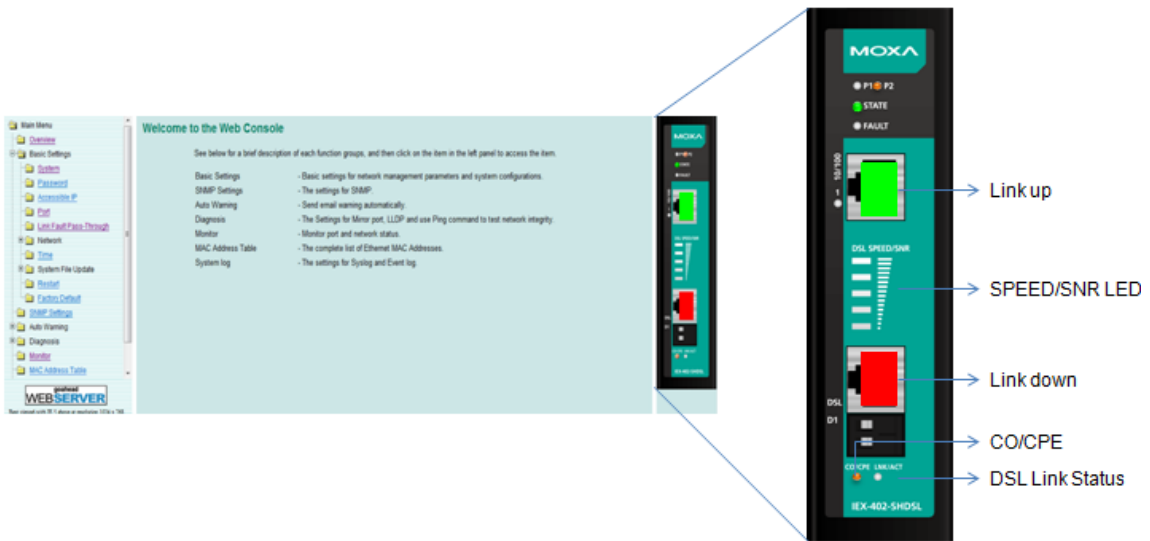

NOTE Please download the IEX MXview plug-in for MXview 2.2 or older versions.

Performance

The IEX series is the ideal solution to extend point-to-point Ethernet connections over 2-wire copper cables. Many factors will affect the DSL performance, including connection distance, environmental noises, and cable quality. The tables below show performance results when tested under noise-free conditions with a line simulator.

IEX-402-SHDSL Series

Distance		Data Rate (kbps)
meter	feet	Annex B & PE.04
500	1640	15304
900	2953	13112
1100	3609	11320
1500	4921	9272
1900	6234	6712
2300	7546	5696
2800	9100	3840
3000	9800	2688
3200	10490	2048
3750	12300	1024
4500	14750	512
5700	18700	384
8000	26240	192

IEX-402-VDSL2 Series

Asymmetric		
Distance		Data Rate
meter	feet	26AWG
200	650	100M/100M
300	980	100M/70M
400	1310	80M/50M
500	1640	60M/30M
600	1960	55/15M
700	2290	50M/8M
900	2900	40M/5M
1100	3600	30M/2.5M
1400	4590	20M/1.5M
2000	6560	10M/1M
2200	7200	8M/1M
2500	8200	5M/768K
2800	9100	3M/512K
3400	11150	1M/256K

Symmetric		
Distance		Data Rate
meter	feet	26AWG
200	650	100M/100M
300	980	75M/75M
400	1310	60M/60M
500	1640	40M/40M
600	1960	30M/30M
700	2290	25M/25M
800	2620	20M/20M
1100	3600	15M/15M
1200	3900	10M/10M
1400	4590	5M/5M
1500	4920	4M/4M
1700	5570	3M/3M
2400	7870	2M/2M
2900	9500	1M/1M

MIB Groups

The Moxa DSL Ethernet extender comes with built-in SNMP (Simple Network Management Protocol) agent software that supports cold/warm start trap, line up/down trap, and RFC 1213 MIB-II.

The standard MIB groups that the Moxa DSL Ethernet extender supports are as follows

MIB II.1—System Group

sysORTable

MIB II.2—Interfaces Group

ifTable

MIB II.4 – IP Group

ipAddrTable

ipNetToMediaTable

IpGroup

IpBasicStatsGroup

IpStatsGroup

MIB II.5—ICMP Group

IcmpGroup

IcmpInputStatus

IcmpOutputStats

MIB II.6—TCP Group

tcpConnTable

TcpGroup

TcpStats

MIB II.7—UDP Group

udpTable

UdpStats

MIB II.10—Transmission Group

dot3

dot3StatsTable

MIB II.11—SNMP Group

SnmpBasicGroup

SnmpInputStats

SnmpOutputStats

The Moxa DSL Ethernet extender also provides a private MIB file, located in the file Moxa-[DSL Ethernet extender's model name]-MIB.my on the Moxa DSL Ethernet extender utility CD-ROM.

Public Traps

- Cold Start

- Link Up
- Link Down
- Authentication Failure

Private Traps

- Configuration Changed
- Power On
- Power Off