

MSM-6226

User's Manual

24-Port L2 Plus Managed Fast Ethernet Switch
+ 2 TP/SFP Gigabit Dual Media

Release 1.0

The information in this document is subject to change without notice. Unless the explicit written permission of ICPDAS Manufacture Corporation, this document in whole or in part shall not be replicated or modified or amended or transmitted, in any form, or by any means manual, electric, electronic, electromagnetic, mechanical, optical or otherwise for any purpose.

DURATION OF HARDWARE WARRANTY

HARDWARE: In accordance with the provisions described under, ICPDAS Manufacture Corporation (hereinafter called "ICPDAS Manufacture") warrants its hardware products (hereinafter referred to as "Product") specified herein to be for a period of twelve (12) months from the date of shipment.

Should a Product fail to perform during the effective warranty period as described above, ICPDAS Manufacture shall replace the defective Product or part, or delivering a functionally equivalent Product or part in receipt of customer's request, provided that the customer complies with the return material authorization (RMA) procedures and returns all defective Product prior to installation of the replacements to ICPDAS Manufacture.

All defective Products must be returned to ICPDAS Manufacture with issuance of a Return Material Authorization number (RMA number) assigned to the reseller from whom the end customer originally purchased the Product. The reseller is responsible for ensuring the shipments are insured, with the transportation charges prepaid and the RMA number clearly marked on the outside of the package. ICPDAS Manufacture will not accept collect shipments or those returned without an RMA number.

ICPDAS Manufacture shall not be responsible for any software, firmware, information or memory data contained in, stored on or integrated with any Product returned to ICPDAS Manufacture pursuant to any warranty.

EXCLUSIONS. The warranty as mentioned above does not apply to the following conditions, in ICPDAS Manufacture's judgment, it contains (1) customer does not comply with the manual instructions offered by ICPDAS Manufacture in installation, operation, repair or maintenance, (2) Product fails due to damage from unusual external or electrical stress, shipment, storage, accident, abuse or misuse, (3) Product is used in an extra hazardous environment or activities, (4) any serial number on the Product has been removed or defaced, (5) this warranty will be of no effect if the repair is via anyone other than ICPDAS Manufacture or the approved agents, or (6) In the event of any failures or delays by either party hereto in the performance of all or any part of this agreement due to acts of God, war, riot, insurrection, national emergency, strike, embargo, storm, earthquake, or other natural forces, or by the acts of anyone not a party to this agreement, or by the inability to secure materials or transportation, then the party so affected shall be executed from any further performance for a period of time after the occurrence as may reasonably be necessary to remedy the effects of that occurrence, but in no event more than sixty (60) days. If any of the stated events should occur, Party A shall promptly notify Party B in writing as soon as commercially practicable, but in no event more than twenty (20) business days and provide documentation evidencing such occurrence. In no event shall the maximum liability of ICPDAS Manufacture under this warranty exceed the purchase price of the Product covered by this warranty.

DISCLAIMER. EXCEPT AS SPECIFICALLY PROVIDED ABOVE AS REQUIRED "AS IS" AND THE WARRANTIES AND REMEDIES STATED ABOVE ARE EXCLUSIVE AND IN LIEU OF ALL OTHERS, ORAL OR WRITTEN, EXPRESS OR IMPLIED. ANY AND ALL OTHER WARRANTIES, INCLUDING IMPLIED WARRANTIES OF MERCHANTABILITY, FITNESS FOR A PARTICULAR PURPOSE AND NONINFRINGEMENT OR THIRD PARTY RIGHTS ARE EXPRESSLY EXCLUDED.

ICPDAS MANUFACTURE SOFTWARE LICENSE AGREEMENT

NOTICE: Please carefully read this Software License Agreement (hereinafter referred to as this "Agreement") before copying or using the accompanying software or installing the hardware unit with pre-enabled software or firmware (each of which is referred to as "Software" in this Agreement). BY COPYING OR USING THE SOFTWARE, YOU ACCEPT ALL OF THE PROVISIONS AND CONDITIONS OF THIS AGREEMENT. THE PROVISIONS EXPRESSED IN THIS AGREEMENT ARE THE ONLY PROVISION UNDER WHICH ICPDAS MANUFACTURE WILL PERMIT YOU TO USE THE SOFTWARE. If you do not accept these provisions and conditions, please immediately return the unused software, manual and the related product. Written approval is **NOT** a prerequisite to the validity or enforceability of this Agreement and no solicitation of any such written approval by or on behalf of ICPDAS Manufacture shall be deemed as an inference to the contrary.

LICENSE GRANT. The end user (hereinafter referred to as "Licensee") of the Software is granted a personal, non-sublicensable, nonexclusive, nontransferable license by ICPDAS Manufacture Corporation ("ICPDAS Manufacture"): (1) To use the ICPDAS Manufacture's software ("Software") in object code form solely on a single central processing unit owned or leased by Licensee or otherwise embedded in the equipment offered by ICPDAS Manufacture. (2) To copy the Software only for backup purposes in support of authorized use of the Software. (3) To use and copy the documentation related to the Software solely in support of authorized use of the Software by Licensee. The License applies to the Software only except other ICPDAS Manufacture's software or hardware products. Without the prior written consent of ICPDAS Manufacture, Licensee has no right to receive any source code or design documentation with respect to the Software.

RESTRICTIONS ON USE; RESERVATION OF RIGHTS. The Software and related documentation are protected under copyright laws. ICPDAS Manufacture and/or its licensors retain all title and ownership in both the Software and its related documentation, including any revisions made by ICPDAS Manufacture. The copyright notice must be reproduced and included with any copy of any portion of the Software or related documentation. Except as expressly authorized above, Licensee shall not copy or transfer the Software or related documentation, in whole or in part. Licensee also shall not modify, translate, decompile, disassemble, use for any competitive analysis, reverse compile or reverse assemble all or any portion of the Software, related documentation or any copy. The Software and related documentation embody ICPDAS Manufacture's confidential and proprietary intellectual property. Licensee is not allowed to disclose the Software, or any information about the operation, design, performance or implementation of the Software and related documentation that is confidential to ICPDAS Manufacture to any third party. Software and related documentation may be delivered to you subject to export authorization required by governments of Taiwan and other countries. You agree that you will not export or re-export any Software or related documentation without the proper export licenses required by the governments of affected countries.

LIMITED SOFTWARE WARRANTY. ICPDAS Manufacture warrants that any media on which the Software is recorded will be free from defects in materials under normal use for a period of twelve (12) months from date of shipment. If a defect in any such media should occur during the effective warranty period, the media may be returned to ICPDAS Manufacture, then ICPDAS Manufacture will replace the media. ICPDAS Manufacture shall not be responsible for the replacement of media if the failure of the media results from accident, abuse or misapplication of the media.

EXCLUSIONS. The warranty as mentioned above does not apply to the Software, which (1) customer does not comply with the manual instructions offered by ICPDAS Manufacture in installation, operation, or maintenance, (2) Product fails due to damage from unusual

external or electrical stress, shipment, storage, accident, abuse or misuse, (3) Product is used in an extra hazardous environment or activities, (4) any

serial number on the Product has been removed or defaced, or (5) this warranty will be of no effect if the repair is via anyone other than Manufacture or the authorized agents. The maximum liability of ICPDAS Manufacture under this warranty is confined to the purchase price of the Product covered by this warranty.

DISCLAIMER. EXCEPT AS PROVIDED ABOVE, THE SOFTWARE IS PROVIDED "AS IS " AND ICPDAS MANUFACTURE AND ITS LICENSORS MAKE NO WARRANTIES, EXPRESS OR IMPLIED, WITH REPECT TO THE SOFTWARE AND DOCUMENTAITON. ICPDAS MANUFACTURE AND ITS LICENSORS DISCLAIM ALL OTHER WARRANTIES, INCLUSIVE OF WITHOUT LIMITATION, IMPLIED WARRANTIES OR MERCHANTABILITY, FITNESS FOR A PARTICULAR PURPOSE AND NONINFRINGEMENT. FURTHER, ICPDAS MANUFACTURE DOES NOT WARRANT, GUARANTEE, OR MAKE ANY REPRESENTATIONS REGARDING THE USE, OR THE RESULTS OF THE USE, OF THE SOFTWARE OR RELATED WRITTEN DOCUMENTAITON IN TERMS OF CORRECTNESS, ACCURACY, RELIABILITY, OR OTHERWISE.

CONSEQUENTIAL DAMAGES. IN NO EVENT SHALL ICPDAS MANUFACTURE OR ITS AUTHORIZED RESELLER BE LIABLE TO LICENSEE OR ANY THIRD PARTY FOR (A) ANY MATTER BEYOND ITS REASONABLE CONTROL OR (B) ANY CONSEQUENTIAL, SPECIAL, INDIRECT OR INCIDENTAL DAMAGES ARISING OUT OF THIS LICENSE OR USE OF THE SOFTWARE PROVIDED BY ICPDAS MANUFACTURE, EVEN IF ICPDAS MANUFACTURE HAS BEEN NOTIFIED OF THE POSSIBILITY OF SUCH DAMAGES IN ADVANCE. IN NO EVENT SHALL THE LIABILITY OF ICPDAS MANUFACTURE IN CONNECTION WITH THE SOFTWARE OR THIS AGREEMENT EXCEED THE PRICE PAID TO ICPDAS MANUFACTURE FOR THE LICENSE.

TERM AND TERMINATION. The License is effective until terminated; however, all of the restrictions in regard to ICPDAS Manufacture's copyright in the Software and related documentation will cease being effective at the date of expiration; Notwithstanding the termination or expiration of the term of this agreement, it is acknowledged and agreed that those obligations relating to use and disclosure of ICPDAS Manufacture's confidential information shall survive. Licensee may terminate this License at any time by destroying the software together with all copies thereof. This License will be immediately terminated if Licensee fails to comply with any term and condition of the Agreement. Upon any termination of this License for any reason, Licensee shall discontinue to use the Software and shall destroy or return all copies of the Software and the related documentation.

GENERAL. This License shall be governed by and construed pursuant to the laws of Taiwan. If any portion hereof is held to be invalid or unenforceable, the remaining provisions of this License shall remain in full force and effect. Neither the License nor this Agreement is assignable or transferable by Licensee without ICPDAS Manufacture's prior written consent; any attempt to do so shall be void. This License constitutes the entire License between the parties with respect to the use of the Software.

LICENSEE ACKNOWLEDGES THAT LICENSEE HAS READ THIS AGREEMENT, UNDERSTANDS IT, AND AGREES TO BE BOUND BY ITS TERMS AND CONDITIONS. LICENSEE FURTHER AGREES THAT THIS AGREEMENT IS THE ENTIRE AND EXCLUSIVE AGREEMENT BETWEEN ICPDAS MANUFACTURE AND LICENSEE.

Table of Contents

CAUTION	IV
ELECTRONIC EMISSION NOTICES	IV
1. Introduction.....	1
1-1. OVERVIEW OF MSM-6226	1
1-2. CHECKLIST	4
1-3. FEATURES	4
1-4. VIEW OF MSM-6226	6
1-4-1. User Interfaces on the Front Panel (Button, LEDs and Plugs).....	6
1-4-2. User Interfaces on the Rear Panel.....	7
2. Installation	8
2-1. STARTING MSM-6226 UP	8
2-1-1. Hardware and Cable Installation	8
2-1-2. Installing Chassis to a 19-Inch Wiring Closet Rail	10
2-1-3. Cabling Requirements	10
2-1-3-1. Cabling Requirements for TP Ports.....	10
2-1-3-2. Cabling Requirements for 1000SX/LX SFP Module	10
2-1-3-3. Switch Cascading in Topology	11
2-1-4. Configuring the Management Agent of MSM-6226.....	14
2-1-4-1. Configuring the Management Agent of MSM-6226 through the Serial RS-232 Port	14
2-1-4-2. Configuring the Management Agent of MSM-6226 through the Ethernet Port.....	16
2-1-5. IP Address Assignment	17
2-2. TYPICAL APPLICATIONS	21
3. Operation of Web-based Management.....	23
3-1. WEB MANAGEMENT HOME OVERVIEW.....	25
3-1-1. System Information.....	28
3-1-2. IP Configuration.....	30
3-1-3. Time Configuration.....	32
3-1-4. Account Configuration	35
3-1-5. Management Security	36
3-1-6. Virtual Stack.....	39
3-2. DHCP SNOOPING	41
3-2-1. DHCP Snooping Config	41
3-2-2. Trust Group.....	42
3-2-3. Lease List.....	44
3-2-4. Counter.....	45
3-3. DHCP RELAY.....	46
3-4. IP-MAC BINDING.....	48
3-5. PORT CONFIGURATION	50
3-5-1. Port Status	50
3-5-2. Port Configuration	54
3-5-3. Port Description	56
3-5-4. Simple Counter	57
3-5-5. Detail Counter	58
3-6. LOOP DETECTION.....	61
3-7. SNMP CONFIGURATION	62
3-8. DHCP BOOT.....	64
3-9. MULTICAST.....	65

3-9-1. IGMP Setting	65
3-9-2. IGMP VLAN	66
3-9-3. Group Allow	68
3-9-4. MVR Setting.....	69
3-9-5. Multicast Status	70
3-9-6. RADIUS IGMP.....	71
3-10. LLDP	73
3-10-1 . LLDP State	73
3-10-2 . LLDP Entry	75
3-10-3 . LLDP Statistics	77
3-11. VLAN.....	79
3-11-1. VLAN Mode	79
3-11-2. Tag-based Group.....	82
3-11-3. PVID	84
3-11-4. Port-based Group	86
3-11-5. Management VLAN.....	88
3-12. MAC TABLE.....	89
3-13. GVRP CONFIGURATION.....	96
3-14. STP CONFIGURATION	101
3-14-1. STP Status.....	101
3-14-2. STP Configuration.....	103
3-14-3. STP Port Configuration.....	105
3-15. MSTP CONFIGURATION	108
3-15-1 Status	108
3-15-2 Region Config.....	109
3-15-3 Instance View.....	110
3-16. TRUNKING CONFIGURATION	118
3-17. 802.1X CONFIGURATION	124
3-18. ALARM CONFIGURATION	134
3-19. CONFIGURATION	136
3-19-1. Save/Restore	137
3-19-2. Config File.....	140
3-20. SECURITY	141
3-21. BANDWIDTH	143
3-22. QoS(QUALITY OF SERVICE CONFIGURATION).....	147
3-23. ACL	151
3- 24. DIAGNOSTICS	160
3- 25. TFTP SERVER	165
3-26. LOG	166
3-27. FIRMWARE UPGRADE.....	167
3-28. REBOOT.....	168
3-29. LOGOUT.....	169
4. Operation of CLI Management	170
4-1. CLI MANAGEMENT	170
4-2. COMMANDS OF CLI	172
4-2-1. Global Commands of CLI.....	173
4-2-2. Local Commands of CLI.....	179
5. Maintenance.....	278
5-1. RESOLVING NO LINK CONDITION	278
5-2. Q&A.....	278
Appendix A Technical Specifications.....	279

Revision History

Release	Date	Revision
<i>1.0</i>	<i>2011/03/21</i>	<i>A1</i>

Caution

Circuit devices are sensitive to static electricity, which can damage their delicate electronics. Dry weather conditions or walking across a carpeted floor may cause you to acquire a static electrical charge.

To protect your device, always:

- Touch the metal chassis of your computer to ground the static electrical charge before you pick up the circuit device.
- Pick up the device by holding it on the left and right edges only.
- **If you need using outdoor device connect to this device with cable then you need to addition an arrester on the cable between outdoor device and this device.**

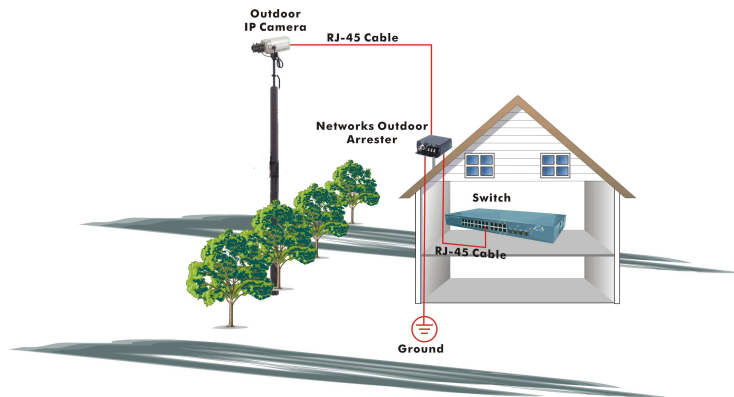

Fig. Addition an arrester between outdoor device and this switch

Electronic Emission Notices

Federal Communications Commission (FCC) Statement

This equipment has been tested and found to comply with the limits for a class A computing device pursuant to Subpart J of part 15 of FCC Rules, which are designed to provide reasonable protection against such interference when operated in a commercial environment.

European Community (CE) Electromagnetic Compatibility Directive

This equipment has been tested and found to comply with the protection requirements of European Emission Standard EN55022/EN61000-3 and the Generic European Immunity Standard EN55024.

EMC:

EN55022(2003)/CISPR-2(2002)	class A
IEC61000-4-2 (2001)	4K V CD, 8KV, AD
IEC61000-4-3(2002)	3V/m
IEC61000-4-4(2001)	1KV – (power line), 0.5KV – (signal line)

Warning:

- Self-demolition on Product is strictly prohibited. Damage caused by self-demolition will be charged for repairing fees.
- Do not place product at outdoor or sandstorm.
- Before installation, please make sure input power supply and product specifications are compatible to each other.
- ***Before importing / exporting configuration please make sure the firmware version is always the same.***
- ***After firmware upgrade, the switch will remove the configuration automatically to latest firmware version.***

About this user's manual

In this user's manual, it will not only tell you how to install and connect your network system but configure and monitor the MSM-6226 through the built-in CLI and web by RS-232 serial interface and Ethernet ports step-by-step. Many explanation in detail of hardware and software functions are shown as well as the examples of the operation for web-based interface and command-line interface (CLI).

Overview of this user's manual

- Chapter 1 "Introduction" describes the features of MSM-6226
- Chapter 2 "Installation"
- Chapter 3 "Operation of Web-based Management"
- Chapter 4 "Operation of CLI Management"
- Chapter 5 "Maintenance"

1. Introduction

1-1. Overview of MSM-6226

MSM-6226, a 24 Fast Ethernet + 2 Gigabit L2 Managed Switch, which implemented 24 10/100Mbps TP + 2 Gigabit dual media ports with TP/SFP(or GBIC), is a standard switch that meets all IEEE 802.3/u/x/z Gigabit, Fast Ethernet and Ethernet specifications. The switch can be managed through RS-232 serial port via directly connection, or through Ethernet port using Telnet or Web-based management unit, associated with SNMP agent. With the SNMP agent, the network administrator can logon the switch to monitor, configure and control each port's activity in a friendly way. The overall network management is enhanced and the network efficiency is also improved to accommodate high bandwidth applications. In addition, the switch features comprehensive and useful function such as DHCP Option 82, QoS (Quality of Service), Spanning Tree, VLAN, Port Trunking, Bandwidth Control, Port Security, SNMP/RMON and IGMP Snooping capability via the intelligent software. It is suitable for both metro-LAN and office application.

Others the new FW increase support the Power saving for reduce the power consumption with "ActiPHY Power Management" and "PerfectReach Power Management" two technique. The device also support DHCP Relay function The DHCP Relay Agent makes it possible for DHCP broadcast messages to be sent over routers that do not support forwarding of these types of messages. The DHCP Relay Agent is therefore the routing protocol that enables DHCP clients to obtain IP addresses from a DHCP server on a remote subnet, or which is not located on the local subnet.

The switch also supports the IEEE Standard——802.1AB (Link Layer Discovery Protocol) · Provide more easy debug tool and enhance the networking management availability, Others it can provide auto-discovery device and topology providing.

• Model Description

Model	Port 25, 26 Configurations
MSM-6226	Two types of media --- TP and SFP Fiber

10/100/1000Mbps TP is a standard Ethernet port that meets all IEEE 802.3/u/x/z Gigabit, Fast Ethernet specifications. 1000Mbps SFP Fiber transceiver is a Gigabit Ethernet port that fully complies with all IEEE 802.3z and 1000Base-SX/LX standards.

1000Mbps Single Fiber WDM (BiDi) transceiver is designed with an optic Wavelength Division Multiplexing (WDM) technology that transports bi-directional full duplex signal over a single fiber simultaneously.

For upgrading firmware, please refer to the Section 3-20 or Section 4-2-2 for more details. The switch will not stop operating while upgrading firmware and after that, the configuration keeps unchanged.

• Key Features in the Device

DHCP Snooping:

This feature enables the DHCP Snooping (MSM-6226 switch) to include information about client when forwarding DHCP requests from a DHCP client to a DHCP server via Trust Port. DHCP snooping can be configured on LAN switches to harden the security on the LAN to only allow clients with specific IP/MAC addresses to have access to the network. In short, DHCP snooping ensures IP integrity on a Layer 2 switched domain.

QoS:

Support Quality of Service by the IEEE 802.1P standard. There are two priority queue and packet transmission schedule using Weighted Round Robin (WRR). User-defined weight classification of packet priority can be based on either VLAN tag on packets or user-defined port priority.

Link Layer Discovery Protocol (LLDP):

IEEE Standard——802.1AB (Link Layer Discovery Protocol) · Provide more easy debug tool and enhance the networking management availability, Others it can provide auto-discovery device and topology providing

Spanning Tree:

Support IEEE 802.1D, IEEE 802.1w (RSTP: Rapid Spanning Tree Protocol) standards.

VLAN:

Support Port-based VLAN and IEEE802.1Q Tag VLAN. Support 4K active VLANs and VLAN ID 1~4094.

Port Trunking:

Support static port trunking and port trunking with IEEE 802.3ad LACP.

Bandwidth Control:

Support ingress and egress per port bandwidth control.

Port Security:

Support allowed, denied forwarding and port security with MAC address.

SNMP/RMON:

SNMP agent and RMON MIB. In the device, SNMP agent is a client software which is operating over SNMP protocol used to receive the command from SNMP manager (server site) and echo the corresponded data, i.e. MIB object. Besides, SNMP agent will actively issue TRAP information when happened.

RMON is the abbreviation of Remote Network Monitoring and is a branch of the SNMP MIB.

The device supports MIB-2 (RFC 1213), Bridge MIB (RFC 1493), RMON MIB (RFC 1757)-statistics Group 1,2,3,9, Ethernet-like MIB (RFC 1643) and so on.

IGMP Snooping:

Support IGMP version 2 (RFC 2236): The function IGMP snooping is used to establish the multicast groups to forward the multicast packet to the member ports, and, in nature, avoid wasting the bandwidth while IP multicast packets are running over the network.

- When queried, sends group membership reports to the group.
- When one of its hosts joins a multicast address group to which none of its other hosts belong, sends unsolicited group membership reports to that group.
- When the last of its hosts in a particular multicast group leaves the group, sends an unsolicited leave group membership report to the all-routers group (244.0.0.2).

Power Saving:

The Power saving using the "ActiPHY Power Management" and "PerfectReach Power Management" two techniques to detect the client idle and cable length automatically and provides the different power. It could efficient to save the switch power and reduce the power consumption.

Access Control List (ACL):

The ACLs are divided into EtherTypes. IPv4, ARP protocol, MAC and VLAN parameters etc. Here we will just go over the standard and extended access lists for TCP/IP. As you create ACEs for ingress classification, you can assign a policy for each port, the policy number is 1-8, however, each policy can be applied to any port. This makes it very easy to determine what type of ACL policy you will be working with.

IP-MAC-Port Binding:

The IP network layer uses a four-byte address. The Ethernet link layer uses a six-byte MAC address. Binding these two address types together allows the transmission of data between the layers. The primary purpose of IP-MAC binding is to restrict the access to a switch to a number of authorized users. Only the authorized client can access the Switch's port by checking the pair of IP-MAC Addresses and port number with the pre-configured database. If an unauthorized user tries to access an IP-MAC binding enabled port, the system will block the access by dropping its packet.

Q-in-Q VLAN for performance & security:

The VLAN feature in the switch offers the benefits of both security and performance. VLAN is used to isolate traffic between different users and thus provides better security. Limiting the broadcast traffic to within the same VLAN broadcast domain also enhances performance. Q-in-Q, the use of double VLAN tags is an efficient method for enabling Subscriber Aggregation. This is very useful in the MAN.

MVR:

Multicast VLAN Registration (MVR) can support carrier to serve content provider using multicast for Video streaming application in the network. Each content provider Video streaming has a dedicated multicast VLAN. The MVR routes packets received in a multicast source VLAN to one or more receive VLANs. Clients are in the receive VLANs and the multicast server is in the source VLAN.

1-2. Checklist

Before you start installing the switch, verify that the package contains the following:

- MSM-6226 24 Fast Ethernet + 2 Gigabit L2 Managed Switch
- Modules (optional)
- Mounting Accessory (for 19" Rack Shelf)
- This User's Manual in CD-ROM
- AC Power Cord
- RS-232 Cable

Please notify your sales representative immediately if any of the aforementioned items is missing or damaged.

1-3. Features

The MSM-6226, a standalone off-the-shelf switch, provides the comprehensive features listed below for users to perform system network administration and efficiently and securely serve your network.

• Hardware

- Supports 24-port 10/100M TP ports with Nway and auto MDIX function
- In MSM-6226, it supports 2 Gigabit dual media ports(TP/SFP) and 2 slots for removable SFP module supporting 1000M SFP fiber module
- In MSM-6226D, it supports 2 Gigabit dual media ports(TP/GBIC) and 2 slots for removable GBIC module supporting 1000M GBIC fiber module
- Power Saving with "ActiPHY Power Management" and "PerfectReach Power Management" techniques.
- Supports on-line pluggable fiber transceiver modules
- Supports 256KB packet buffer and 128KB control memory
- Maximal packet length can be up to 1536 bytes
- Full-duplex flow control (IEEE802.3x) and half-duplex backpressure
- Extensive front-panel diagnostic LEDs; System: Power, CPURUN, ACT / FDX / SPD(LEDSET), 10/100Mbps TP Port1-24:LINK/ACT, FDX, SPD, 10/100/1000Mbps/Fiber port 25, 26: LINK/ACT, FDX, SPD

• Management

- Supports concisely the status of port and easily port configuration
- Supports per port traffic monitoring counters
- Supports a snapshot of the system Information when you login
- Supports port mirror function
- Supports the static trunk function

- Supports 802.1Q VLAN with 4K entries.
- Supports user management and limits three users to login
- Supports DHCP Broadcasting Suppression to avoid network suspended or crashed
- Supports to send the trap event while monitored events happened
- Supports Link Layer Discovery Protocol (LLDP, IEEE802.1AB)
- Supports default configuration which can be restored to overwrite the current configuration which is working on via web browser and CLI
- Supports on-line plug/unplug SFP/GBIC modules
- Supports 5 kinds of QoS, are as follows, MAC Priority, 802.1p Priority, IP TOS Priority, and DiffServ DSCP Priority.
- Built-in web-based management and CLI management, providing a more convenient UI for the user
- Supports port mirror function with ingress/egress traffic
- Supports rapid spanning tree (802.1w RSTP)
- Supports 802.1X port security on a VLAN
- Supports user management and only first login administrator can configure the device. The rest of users can only view the switch
- SNMP access can be disabled and prevent from illegal SNMP access
- Supports Ingress, Non-unicast and Egress Bandwidth rating management
- The trap event and alarm message can be transferred via e-mail and mobile phone short message
- Supports diagnostics to let administrator knowing the hardware status
- Supports external loopback test to check if the link is ok
- TFTP for firmware upgrade, system log upload and config file import/export
- Supports remote boot the device through user interface and SNMP
- Supports network time synchronization and daylight saving
- Supports 120 event log records in the main memory and display on the local console

1-4. View of MSM-6226



Fig. 1-1 Full View of MSM-6226D with SFP Module

1-4-1. User Interfaces on the Front Panel (Button, LEDs and Plugs)

There are 24 TP Fast Ethernet ports and 2 slots for optional removable modules on the front panel of the switch. LED display area, locating on the front panel, contains a CPURUN, Power LED and 26 ports working status of the switch.

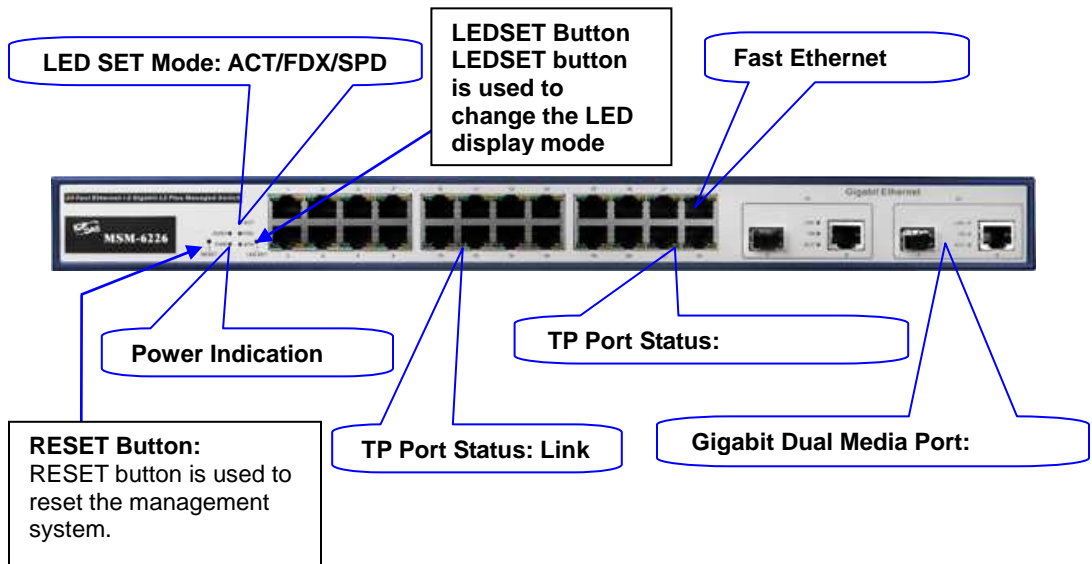

Fig. 1-2 Front View of MSM-6226 with SFP Module

- LED Indicators

LED	Color	Function
System LED		
CPURUN	Green	Lit when CPU is on and good
POWER	Green	Lit when AC power is on and good
ACT	Green	Lit when LEDSET set on active mode
FDX	Green	Lit when LEDSET set on full-duplex mode
SPD	Green	Lit when LEDSET set on speed mode
10/100Mbps Ethernet TP Port 1 to 24 LED		
LNK	Green	Lit when connection with remote device is good Off when cable connection is not good
ACT/FDX/ SPD	Amber (TP Port 1 to 24 LED)	a. LEDSET set on ACT (active) mode: Blinks when any traffic is present b. LEDSET set on FDX (full-duplex) mode: Lit when full-duplex mode is active Blinks when any collision is present c. LEDSET set on SPD (speed) mode: Lit when 100Mbps speed is active Off when 10Mbps speed is active
10/100/1000Mbps Gigabit TP/Fiber Port 25, 26 LED		
LNK	Green	Lit when connection with remote device is good Off when cable connection is not good
FB	Green	Lit when Fiber port is active Off when TP port is active
ACT/FDX/ SPD	Green (Port 25, 26 LED)	a. LEDSET set on ACT (active) mode: Blinks when any traffic is present b. LEDSET set on FDX (full-duplex) mode: Lit when full-duplex mode is active Blinks when any collision is present c. LEDSET set on SPD (speed) mode: Lit when 1000Mbps speed is active Off when 10/100Mbps speed is active

Table1-1

1-4-2. User Interfaces on the Rear Panel

One RS-232 DB-9 interface is offered for configuration or management. And there is one AC power input socket for having the switch powered on or off.

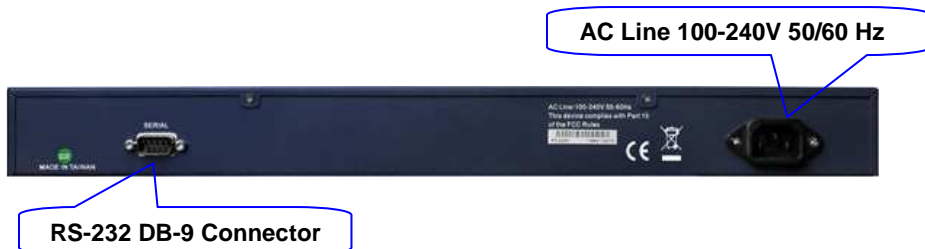

Fig. 1-3 Rear View of MSM-6226/D

2. Installation

2-1. Starting MSM-6226 Up

This section will give users a quick start for:

- Hardware and Cable Installation
- Management Station Installation
- Software booting and configuration

2-1-1. Hardware and Cable Installation

At the beginning, please do first:

⇒ Wear a grounding device to avoid the damage from electrostatic discharge

- **Installing Optional SFP/GBIC Fiber Transceivers to the MSM-6226 Managed Switch**

Note: If you have no modules, please skip this section.

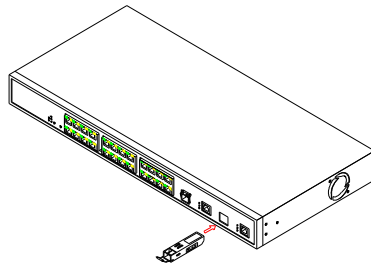

Fig. 2-1 Installation of Optional SFP Fiber Transceiver

- **Connecting the SFP Module to the Chassis:**

The optional SFP modules are hot swappable, so you can plug or unplug it before or after powering on.

1. Verify that the SFP module is the right model and conforms to the chassis
2. Slide the module along the slot. Also be sure that the module is properly seated against the slot socket/connector
3. Install the media cable for network connection
4. Repeat the above steps, as needed, for each module to be installed into slot(s)
5. Have the power ON after the above procedures are done

- **TP Port and Cable Installation**

- ⇒ In the switch, TP port supports MDI/MDI-X auto-crossover, so both types of cable, straight-through (Cable pin-outs for RJ-45 jack 1, 2, 3, 6 to 1, 2, 3, 6 in 10/100M TP; 1, 2, 3, 4, 5, 6, 7, 8 to 1, 2, 3, 4, 5, 6, 7, 8 in Gigabit TP) and crossed-over (Cable pin-outs for RJ-45 jack 1, 2, 3, 6 to 3, 6, 1, 2) can be used. It means you do not have to tell from them, just plug it.
- ⇒ Use Cat. 5 grade RJ-45 TP cable to connect to a TP port of the switch and the other end is connected to a network-aware device such as a workstation or a server.
- ⇒ Repeat the above steps, as needed, for each RJ-45 port to be connected to a Gigabit 10/100/1000 TP device.

Now, you can start having the switch in operation.

- **Power On**

The switch supports 100-240 VAC, 50-60 Hz power supply. The power supply will automatically convert the local AC power source to DC power. It does not matter whether any connection plugged into the switch or not when power on, even modules as well. After the power is on, all LED indicators will light up immediately and then all off except the power LED still keeps on. This represents a reset of the system.

- **Firmware Loading**

After resetting, the bootloader will load the firmware into the memory. It will take about 30 seconds, after that, the switch will flash all the LED once and automatically performs self-test and is in ready state.

2-1-2. Installing Chassis to a 19-Inch Wiring Closet Rail

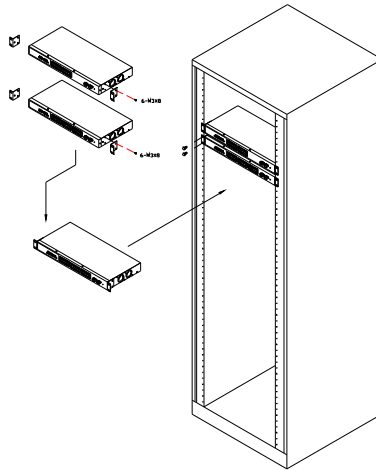

Fig. 2-2

Caution: Allow a proper spacing and proper air ventilation for the cooling fan at both sides of the chassis.

- ⇒ Wear a grounding device for electrostatic discharge.
- ⇒ Screw the mounting accessory to the front side of the switch (See Fig. 2-2).
- ⇒ Place the Chassis into the 19-inch wiring closet rail and locate it at the proper position. Then, fix the Chassis by screwing it.

2-1-3. Cabling Requirements

To help ensure a successful installation and keep the network performance good, please take a care on the cabling requirement. Cables with worse specification will render the LAN to work poorly.

2-1-3-1. Cabling Requirements for TP Ports

- ⇒ For Fast Ethernet TP network connection
 - The grade of the cable must be Cat. 5 or Cat. 5e with a maximum length of 100 meters.
- ⇒ Gigabit Ethernet TP network connection
 - The grade of the cable must be Cat. 5 or Cat. 5e with a maximum length of 100 meters. Cat. 5e is recommended.

2-1-3-2. Cabling Requirements for 1000SX/LX SFP Module

It is more complex and comprehensive contrast to TP cabling in the fiber media. Basically, there are two categories of fiber, multi mode (MM) and single mode (SM). The later is categorized into several classes by the distance it supports. They are SX, LX, LHX, XD, and ZX. From the viewpoint of connector type, there mainly are LC and BiDi LC.

- Gigabit Fiber with multi-mode LC SFP module
- Gigabit Fiber with single-mode LC SFP module

- Gigabit Fiber with BiDi LC 1310nm SFP module
- Gigabit Fiber with BiDi LC 1550nm SFP module

The following table lists the types of fiber that we support and those else not listed here are available upon request.

Multi-mode Fiber Cable and Modal Bandwidth				
IEEE 802.3z Gigabit Ethernet 1000SX 850nm	Multi-mode 62.5/125μm		Multi-mode 50/125μm	
	Modal Bandwidth	Distance	Modal Bandwidth	Distance
	160MHz-Km	220m	400MHz-Km	500m
	200MHz-Km	275m	500MHz-Km	550m
1000Base- LX/LHX/XD/ZX	SFP. LC.S10/30/50/70/B0 Km (or GBIC.SC.S10/30/50 Km)			
	Single-mode Fiber 9/125μm			
	Single-mode transceiver 1310nm 10Km			
	Single-mode transceiver 1550nm 30, 50, 70, 110Km			
1000Base-LX Single Fiber WDM Module	SFP.BL3.S20 (or GBIC.BS3.S20)	Single-Mode *20Km	TX(Transmit)	1310nm
			RX(Receive)	1550nm
	SFP.BL5.S20 (or GBIC.BS5.S20)	Single-Mode *20Km	TX(Transmit)	1550nm
			RX(Receive)	1310nm

Table2-1

2-1-3-3. Switch Cascading in Topology

- **Takes the Delay Time into Account**

Theoretically, the switch partitions the collision domain for each port in switch cascading that you may up-link the switches unlimitedly. In practice, the network extension (cascading levels & overall diameter) must follow the constraint of the IEEE 802.3/802.3u/802.3z and other 802.1 series protocol specifications, in which the limitations are the timing requirement from physical signals defined by 802.3 series specification of Media Access Control (MAC) and PHY, and timer from some OSI layer 2 protocols such as 802.1d, 802.1q, LACP and so on.

The fiber, TP cables and devices' bit-time delay (round trip) are as follows:

1000Base-X TP, Fiber		100Base-TX TP		100Base-FX Fiber	
Round trip Delay: 4096		Round trip Delay: 512			
Cat. 5 TP Wire:	11.12/m	Cat. 5 TP Wire:	1.12/m	Fiber Cable:	1.0/m
Fiber Cable :	10.10/m	TP to fiber Converter: 56			
Bit Time unit : 1ns (1sec./1000 Mega bit)		Bit Time unit: 0.01μs (1sec./100 Mega bit)			

Table 2-2

Sum up all elements' bit-time delay and the overall bit-time delay of wires/devices must be within Round Trip Delay (bit times) in a half-duplex network segment (collision domain). For full-duplex operation, this will not be applied. You may use the TP-Fiber module to extend the TP node distance over fiber optic and

provide the long haul connection.

- **Typical Network Topology in Deployment**

A hierarchical network with minimum levels of switch may reduce the timing delay between server and client station. Basically, with this approach, it will minimize the number of switches in any one path; will lower the possibility of network loop and will improve network efficiency. If more than two switches are connected in the same network, select one switch as Level 1 switch and connect all other switches to it at Level 2. Server/Host is recommended to connect to the Level 1 switch. This is general if no VLAN or other special requirements are applied.

Case1: All switch ports are in the same local area network. Every port can access each other (See Fig. 2-3).

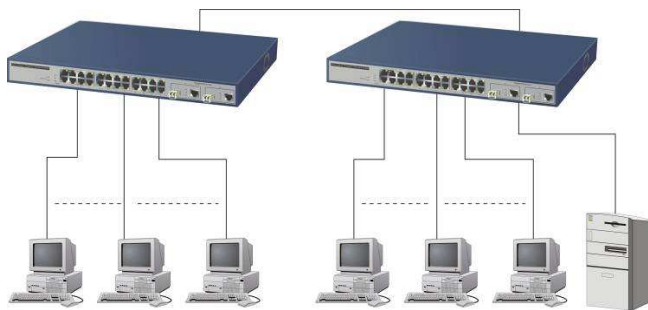

Fig. 2-3 No VLAN Configuration Diagram

If VLAN is enabled and configured, each node in the network that can communicate each other directly is bounded in the same VLAN area.

Here VLAN area is defined by what VLAN you are using. The switch supports both port-based VLAN and tag-based VLAN. They are different in practical deployment, especially in physical location. The following diagram shows how it works and what the difference they are.

Case2a: Port-based VLAN (See Fig.2-4).

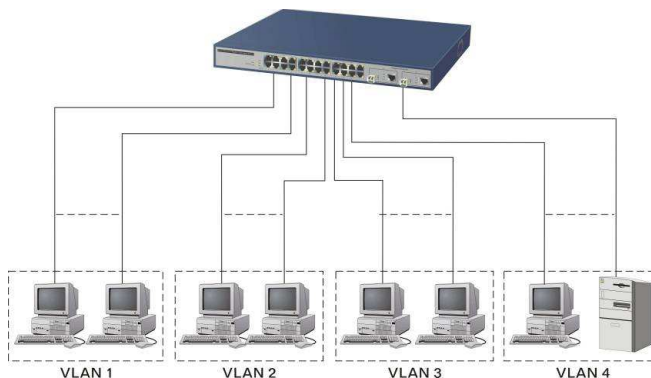

Fig. 2-4 Port-based VLAN Diagram

1. The same VLAN members could not be in different switches.
2. Every VLAN members could not access VLAN members each other.
3. The switch manager has to assign different names for each VLAN groups at one switch.

Case 2b: Port-based VLAN (See Fig.2-5).

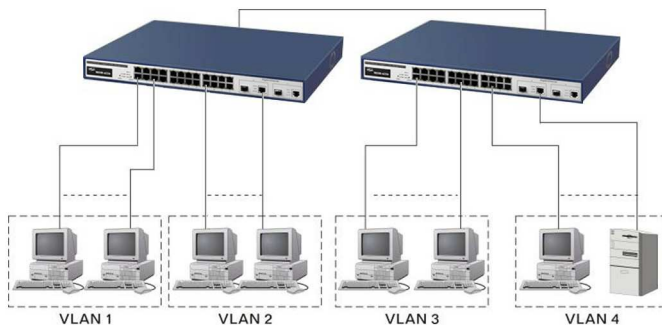

Fig. 2-5 Port-based VLAN Diagram

1. VLAN1 members could not access VLAN2, VLAN3 and VLAN4 members.
2. VLAN2 members could not access VLAN1 and VLAN3 members, but they could access VLAN4 members.
3. VLAN3 members could not access VLAN1, VLAN2 and VLAN4.
4. VLAN4 members could not access VLAN1 and VLAN3 members, but they could access VLAN2 members.

Case3a: The same VLAN members can be at different switches with the same VID (See Fig. 2-6).

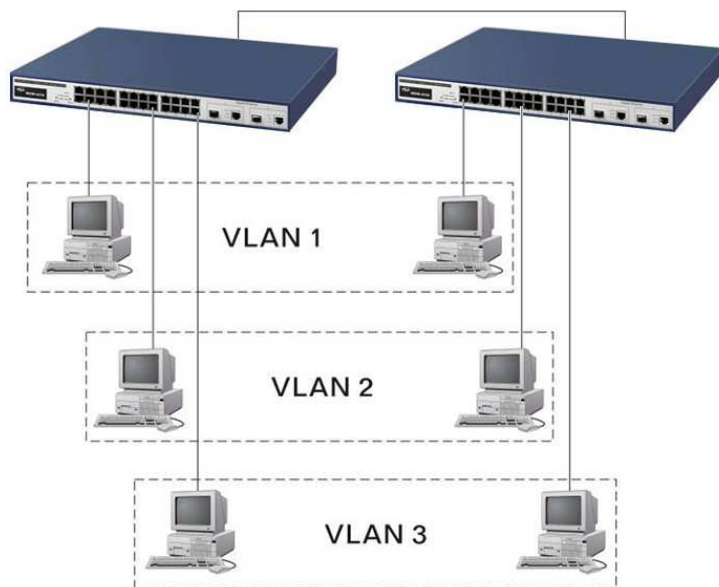

Fig. 2-6 Attribute-based VLAN Diagram

2-1-4. Configuring the Management Agent of MSM-6226

We offer you three ways to startup the switch management function. They are RS-232 console, CLI, and Web. Users can use any one of them to monitor and configure the switch. You can touch them through the following procedures.

Section 2-1-4-1: Configuring the Management Agent of MSM-6226 through the Serial RS-232 Port

Section 2-1-4-2: Configuring the Management Agent of MSM-6226 through the Ethernet Port

Note: Please first modify the IP address, Subnet mask, Default gateway and DNS through RS-232 console, and then do the next.

2-1-4-1. Configuring the Management Agent of MSM-6226 through the Serial RS-232 Port

To perform the configuration through RS-232 console port, the switch's serial port must be directly connected to a DCE device, for example, a PC, through RS-232 cable with DB-9 connector. Next, run a terminal emulator with the default setting of the switch's serial port. With this, you can communicate with the switch.

In the switch, RS-232 interface only supports baud rate 57.6k bps with 8 data bits, 1 stop bit, no parity check and no flow control.

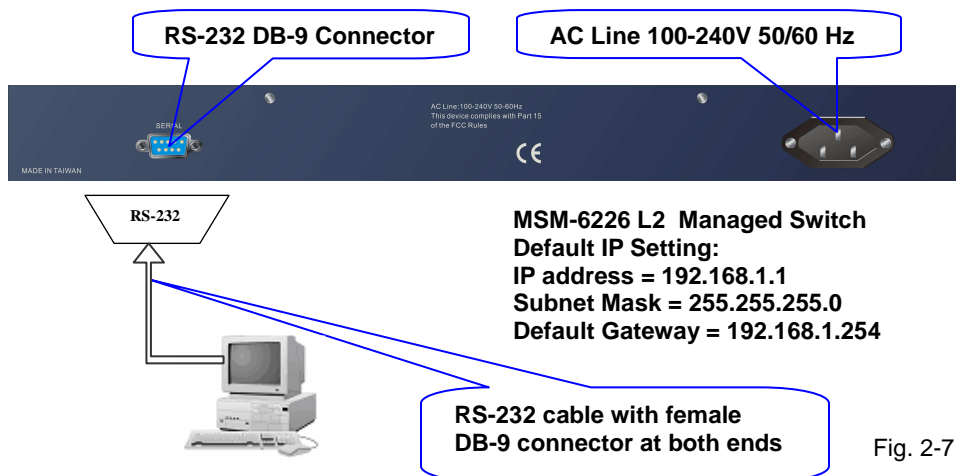

Terminal or Terminal

To configure the switch, please follow the procedures below:

1. Find the RS-232 DB-9 cable with female DB-9 connector bundled. Normally, it just uses pins 2, 3 and 7. See also Appendix B for more details on Null Modem Cable Specifications.
2. Attaches the DB-9 female cable connector to the male serial RS-232 DB-9 connector on the switch.
3. Attaches the other end of the serial RS-232 DB-9 cable to PC's serial port, running a terminal emulator supporting VT100/ANSI terminal with The switch's serial port default settings. For example, Windows98/2000/XP HyperTerminal utility.

Note: The switch's serial port default settings are listed as follows:

Baud rate	57600
Stop bits	1
Data bits	8
Parity	N
Flow control	none

4. When you complete the connection, then press **<Enter>** key. The login prompt will be shown on the screen. The default username and password are shown as below:

Username = admin Password = admin

• **Set IP Address, Subnet Mask and Default Gateway IP Address**

Please refer to Fig. 2-7 CLI Management for details about ICPDAS Manufacture's setting. They are default setting of IP address. You can first either configure your PC IP address or change IP address of the switch, next to change the IP address of default gateway and subnet mask.

For example, your network address is 10.1.1.0, and subnet mask is 255.255.255.0. You can change the switch's default IP address 192.168.1.1 to 10.1.1.1 and set the subnet mask to be 255.255.255.0. Then, choose your default gateway, may be it is 10.1.1.254.

Default Value	MSM-6226	Your Network Setting
IP Address	192.168.1.1	10.1.1.1
Subnet	255.255.255.0	255.255.255.0
Default Gateway	192.168.1.254	10.1.1.254

Table 2-3

After completing these settings in the switch, it will reboot to have the configuration taken effect. After this step, you can operate the management through the network, no matter it is from a web browser or Network Management System (NMS).

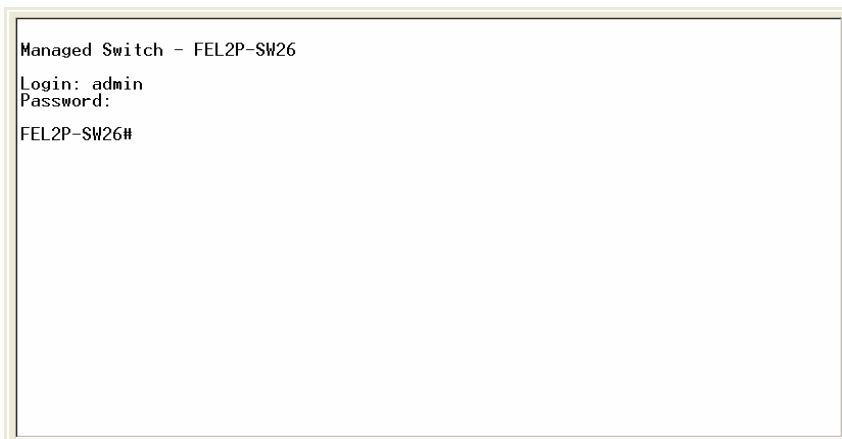
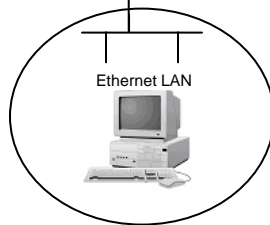

Fig. 2-8 the Login Screen for CLI

2-1-4-2. Configuring the Management Agent of MSM-6226 through the Ethernet Port

There are three ways to configure and monitor the switch through the switch's Ethernet port. They are CLI, Web browser and SNMP manager. The user interface for the last one is NMS dependent and does not cover here. We just introduce the first two types of management interface.

MSM-6226 L2 Managed Switch
Default IP Setting:
IP = 192.168.1.1
Subnet Mask = 255.255.255.0
Default Gateway = 192.168.1.254



Assign a reasonable IP address,
For example:
IP = 192.168.1.100
Subnet Mask = 255.255.255.0
Default Gateway = 192.168.1.254

Fig. 2-9

• Managing MSM-6226 through Ethernet Port

Before you communicate with the switch, you have to finish first the configuration of the IP address or to know the IP address of the switch. Then, follow the procedures listed below.

1. Set up a physical path between the configured the switch and a PC by a qualified UTP Cat. 5 cable with RJ-45 connector.

Note: If PC directly connects to the switch, you have to setup the same subnet mask between them. But, subnet mask may be different for the PC in the remote site. Please refer to Fig. 2-9 about the switch's default IP address information.

2. Run CLI or web browser and follow the menu. Please refer to Chapter 3 and Chapter 4.

Please Input Username & Password

Username:

Password:

[Forget Password?](#)



Fig. 2-10 the Login Screen for Web

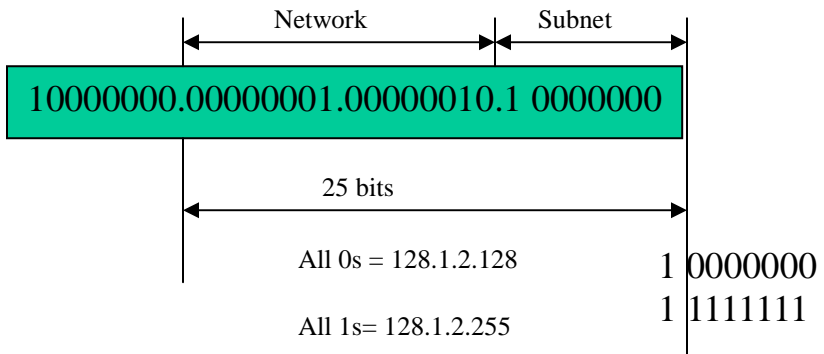

In this diagram, you can see the subnet mask with 25-bit long, 255.255.255.128, contains 126 members in the sub-netted network. Another is that the length of network prefix equals the number of the bit with 1s in that subnet mask. With this, you can easily count the number of IP addresses matched. The following table shows the result.

Prefix Length	No. of IP matched	No. of Addressable IP
/32	1	-
/31	2	-
/30	4	2
/29	8	6
/28	16	14
/27	32	30
/26	64	62
/25	128	126
/24	256	254
/23	512	510
/22	1024	1022
/21	2048	2046
/20	4096	4094
/19	8192	8190
/18	16384	16382
/17	32768	32766
/16	65536	65534

Table 2-4

According to the scheme above, a subnet mask 255.255.255.0 will partition a network with the class C. It means there will have a maximum of 254 effective nodes existed in this sub-netted network and is considered a physical network in an autonomous network. So it owns a network IP address which may looks like 168.1.2.0.

With the subnet mask, a bigger network can be cut into small pieces of network. If we want to have more than two independent networks in a worknet, a partition to the network must be performed. In this case, subnet mask must be applied.

For different network applications, the subnet mask may look like 255.255.255.240. This means it is a small network accommodating a maximum of 15 nodes in the network.

Default gateway:

For the routed packet, if the destination is not in the routing table, all the traffic is put into the device with the designated IP address, known as default router. Basically, it is a routing policy. The gateway setting is used for Trap Events Host only in the switch.

For assigning an IP address to the switch, you just have to check what the IP address of the network will be connected with the switch. Use the same network address and append your host address to it.

IP Configuration

DHCP Setting	Disable
IP Address	192.168.2.25
Subnet Mask	255.255.255.0
Default Gateway	192.168.2.254
DNS Server	Manual 0.0.0.0

Apply

Fig. 2-12

First, IP Address: as shown in the Fig. 2-12, enter “192.168.1.1”, for instance. For sure, an IP address such as 192.168.1.x must be set on your PC.

Second, Subnet Mask: as shown in the Fig. 2-12, enter “255.255.255.0”. Any subnet mask such as 255.255.255.x is allowable in this case.

DNS:

The Domain Name Server translates human readable machine name to IP address. Every machine on the Internet has a unique IP address. A server generally has a static IP address. To connect to a server, the client needs to know the IP of the server. However, user generally uses the name to connect to the server. Thus, the switch DNS client program (such as a browser) will ask the DNS to resolve the IP address of the named server.

2-2. Typical Applications

The MSM-6226 implements 24 Fast Ethernet TP ports with auto MDIX and 2 Gigabit dual media ports with SFP/GBIC for removable module supported comprehensive fiber types of connection, including LC, BiDi LC for SFP and LC/SC, BiDi LC/SC for GBIC. For more details on the specification of the switch, please refer to Appendix A.

The switch is suitable for the following applications.

- Central Site/Remote site application is used in carrier or ISP (See Fig. 2-13)
- Peer-to-peer application is used in two remote offices (See Fig. 2-14)
- Office network(See Fig. 2-15)

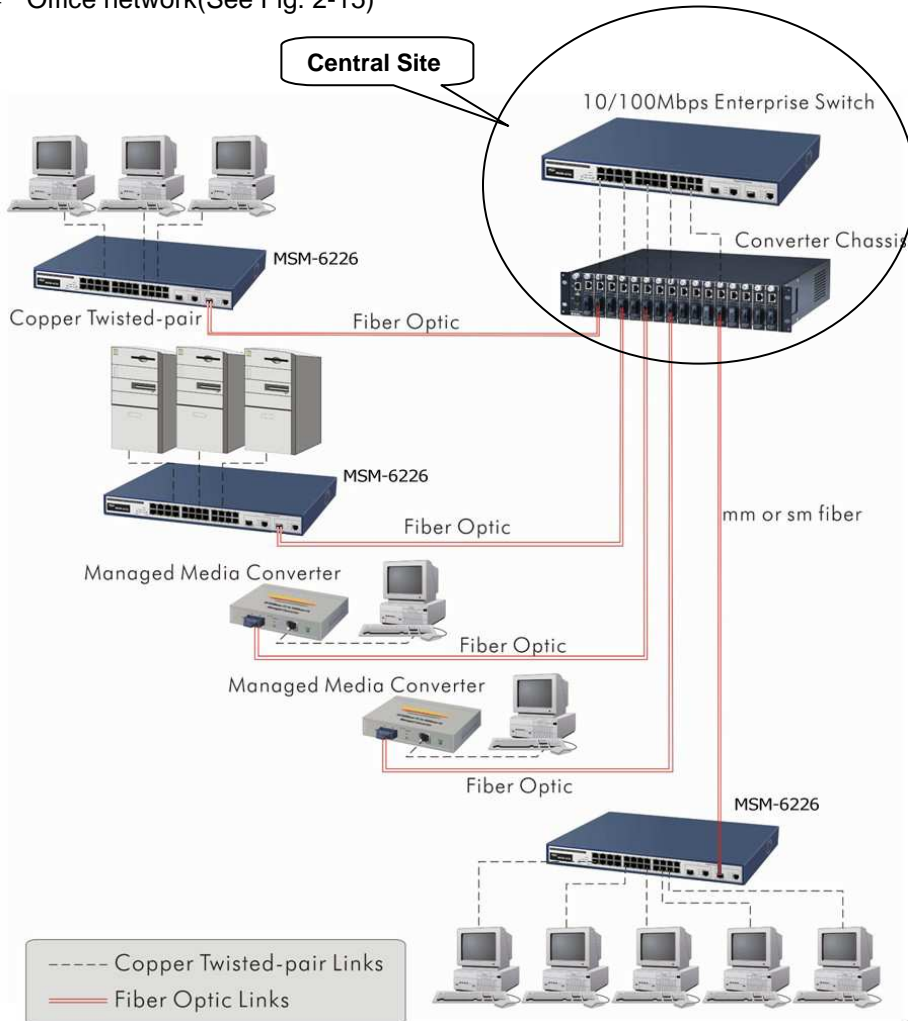

Fig. 2-13 Network Connection between Remote Site and Central Site

Fig. 2-13 is a system wide basic reference connection diagram. This diagram demonstrates how the switch connects with other network devices and hosts.

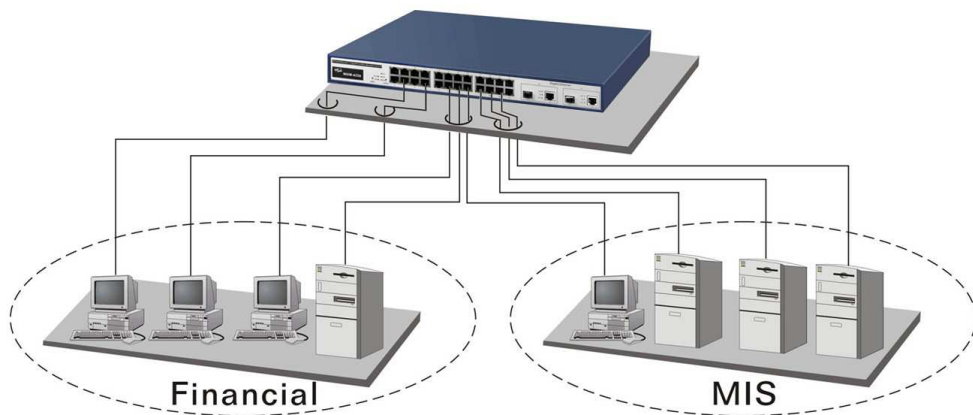

Fig. 2-14 Peer-to-peer Network Connection

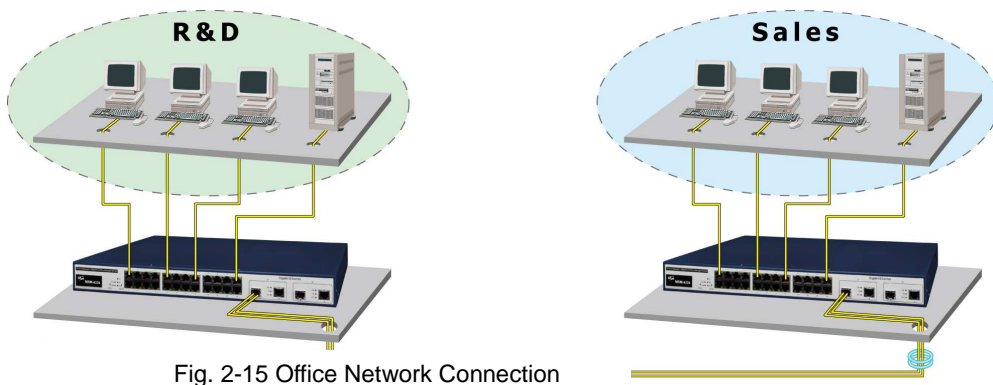
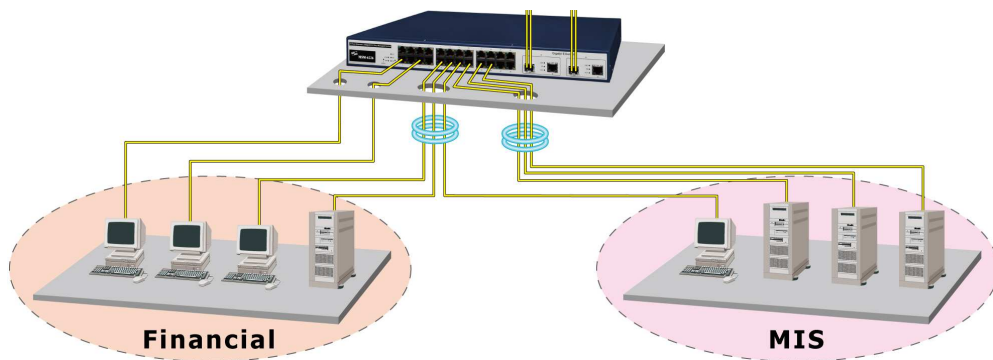

Fig. 2-15 Office Network Connection



3. Operation of Web-based Management

This chapter instructs you how to configure and manage the MSM-6226 through the web user interface it supports, to access and manage the 24 10/100Mbps TP + 2 Gigabit dual media ports with TP/SFP(or GBIC)Fiber management Ethernet switch. With this facility, you can easily access and monitor through any one port of the switch all the status of the switch, including MIBs status, each port activity, Spanning tree status, port aggregation status, multicast traffic, VLAN and priority status, even illegal access record and so on.

The default values of the managed switch are listed in the table below:

IP Address	192.168.1.1
Subnet Mask	255.255.255.0
Default Gateway	192.168.1.254
Username	admin
Password	admin

Table 3-1

After the managed switch has been finished configuration in the CLI via the switch's serial interface, you can browse it. For instance, type <http://192.168.1.1> in the address row in a browser, it will show the following screen (see Fig.3-1) and ask you inputting username and password in order to login and access authentication. The default username and password are both "admin". For the first time to use, please enter the default username and password, then click the **<Login>** button. The login process now is completed.

Just click the link of "Forget Password" in WebUI (See Fig. 3-1) or input "Ctrl+Z" in CLI's login screen (See Fig. 4-1~4-2) in case the user forgets the manager's password. Then, the system will display a serial No. for the user. Write down this serial No. and contact your vendor, the vendor will give you a temporary password. Use this new password as ID and Password, and it will allow the user to login the system with manager authority temporarily. Due to the limit of this new password, the user only can login the system one time, therefore, please modify your password immediately after you login in the system successfully.

In this login menu, you have to input the complete username and password respectively, the switch will not give you a shortcut to username automatically. This looks inconvenient, but safer.

In the switch, it supports a simple user management function allowing only one administrator to configure the system at the same time. If there are two or more users using administrator's identity, the switch will allow the only one who logins first to configure the system. The rest of users, even with administrator's identity, can only monitor the system. For those who have no administrator's identity, can only monitor the system. There are only a maximum of three users able to login simultaneously in the switch.

To optimize the display effect, we recommend you use Microsoft IE 6.0 above, Netscape V7.1 above or FireFox V1.00 above and have the resolution 1024x768. The switch supported neutral web browser interface.

In Fig. 3-2, for example, left section is the whole function tree with web user interface and we will travel it through this chapter.

Please Input Username & Password

Username:

Password:

[Forget Password?](#)



Fig. 3-1

3-1. Web Management Home Overview

After you login, the switch shows you the system information as Fig. 3-2. This page is default and tells you the basic information of the system, including “Model Name”, “System Description”, “Location”, “Contact”, “Device Name”, “System Up Time”, “Current Time”, “BIOS Version”, “Firmware Version”, “Hardware-Mechanical Version”, “Serial Number”, “Host IP Address”, “Host MAC Address”, “Device Port”, “RAM Size” and “Flash Size”. With this information, you will know the software version used, MAC address, serial number, how many ports good and so on. This is helpful while malfunctioning.

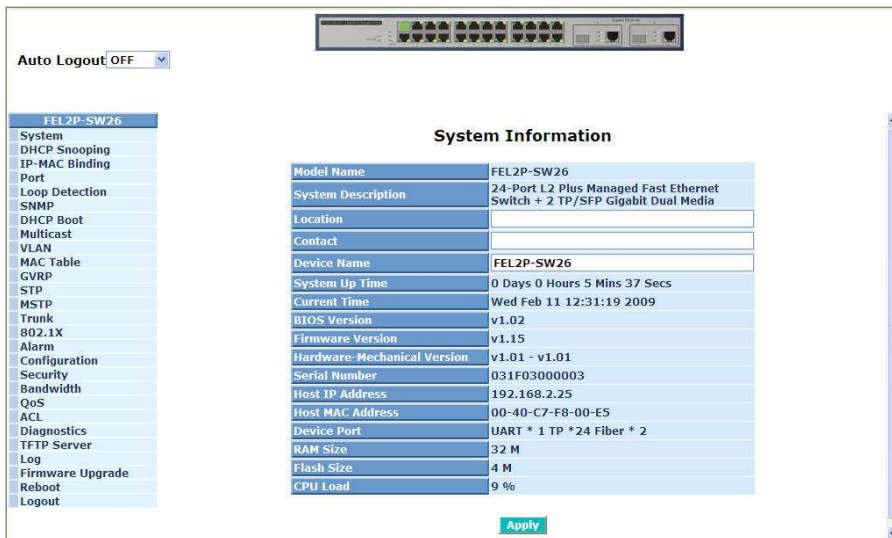

The screenshot displays a web management interface for a switch. At the top, there is a navigation menu with 'FEL2P-SW26' selected. Below the menu is a list of system information fields. At the top right, there is a small image of the switch's front panel. The main content area is titled 'System Information' and contains a table of system details. An 'Apply' button is located at the bottom right of the table.

System Information	
Model Name	FEL2P-SW26
System Description	24-Port L2 Plus Managed Fast Ethernet Switch + 2 TP/SFP Gigabit Dual Media
Location	
Contact	
Device Name	FEL2P-SW26
System Up Time	0 Days 0 Hours 5 Mins 37 Secs
Current Time	Wed Feb 11 12:31:19 2009
BIOS Version	v1.02
Firmware Version	v1.15
Hardware-Mechanical Version	v1.01 - v1.01
Serial Number	031F03000003
Host IP Address	192.168.2.25
Host MAC Address	00-40-C7-F8-00-E5
Device Port	UART * 1 TP * 24 Fiber * 2
RAM Size	32 M
Flash Size	4 M
CPU Load	9 %

Fig. 3-2

• The Information of Page Layout

- On the top side, it shows the front panel of the switch. In the front panel, the linked ports will display green; as to the ports, which are link off, they will be dark. For the optional modules, the slot will show only a cover plate if no module exists and will show a module if a module is present. The image of module depends on the one you inserted. The same, if disconnected, the port will show just dark, if linked, green.

In this device, there are clicking functions on the panel provided for the information of the ports. These are very convenient functions for browsing the information of a single port. When clicking the port on the front panel, an information window for the port will be pop out. (See Fig. 3-3)

Port 1 Detail Information

Link	Up
State	Enabled
Auto Negotiation	Enabled
Speed/Duplex	100M/Full
Rx Pause	ON
Tx Pause	ON
Tx Byte	600865
Rx Byte	1926329
Tx Packet	1322
Rx Packet	19798
Tx Collision	0
Rx Error Packet	0
Description	

[Close](#)

Fig. 3-3 port detail information

In Fig. 3-3, it shows the basic information of the clicked port. With this, you'll see the information about the port status, traffic status and bandwidth rating for egress and ingress respectively.

- On the left-top corner, there is a pull-down list for Auto Logout. For the sake of security, we provide auto-logout function to protect you from illegal user as you are leaving. If you do not choose any selection in Auto Logout list, it means you turn on the Auto Logout function and the system will be logged out automatically when no action on the device 3 minutes later. If OFF is chosen, the screen will keep as it is. Default is ON.
- On the left side, the main menu tree for web is listed in the page. They are hierarchical menu. Open the function folder, a sub-menu will be shown. The functions of each folder are described in its corresponded section respectively. When clicking it, the function is performed. The following list is the full function tree for web user interface.

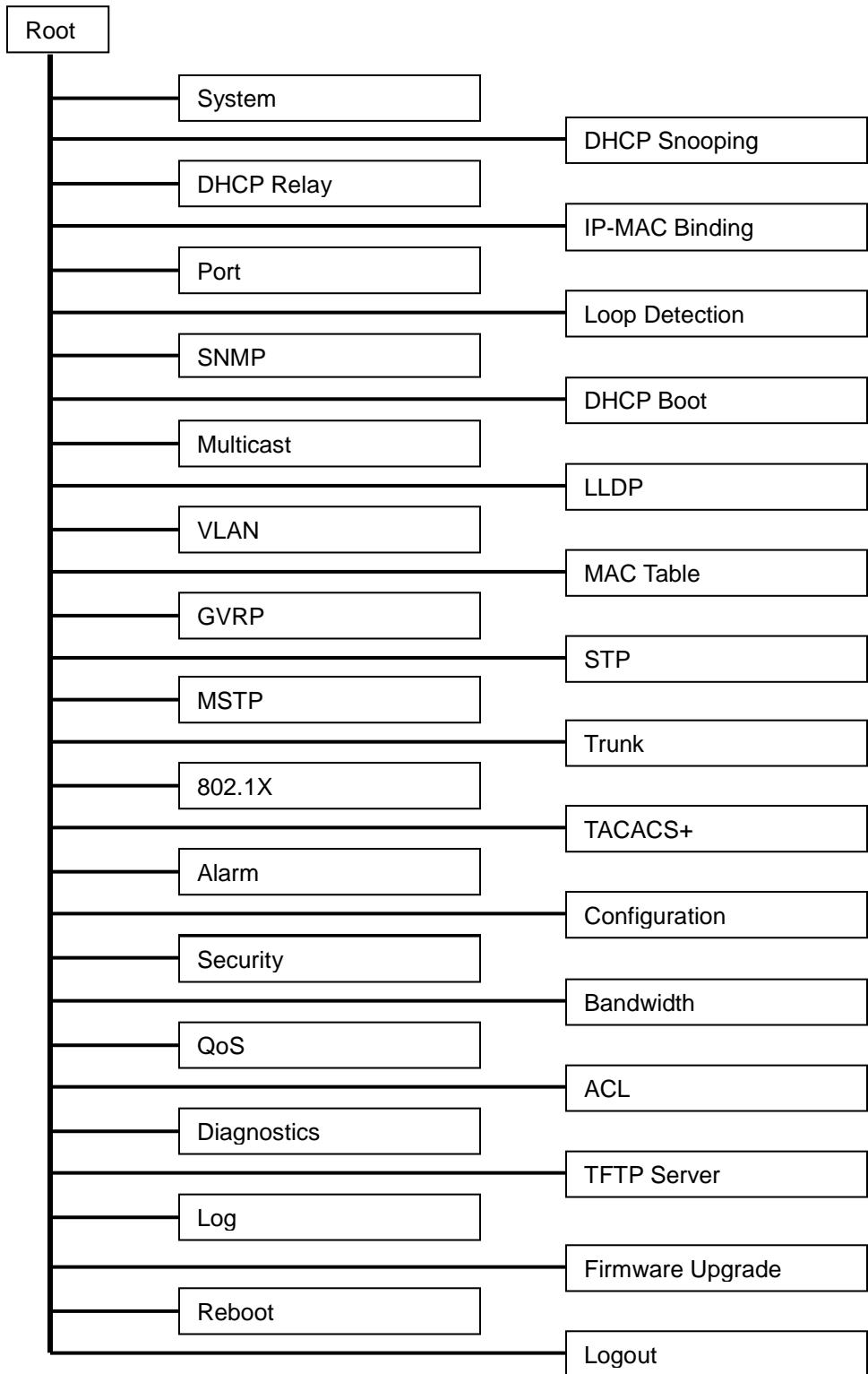

3-1-1. System Information

Function name:

System Information

Function description:

Show the basic system information.

System Information

Model Name	FEL2P-SW26
System Description	24-Port L2 Plus Managed Fast Ethernet Switch + 2 TP/SFP Gigabit Dual Media
Location	
Contact	
Device Name	FEL2P-SW26
System Up Time	0 Days 4 Hours 34 Mins 37 Secs
Current Time	Fri Feb 13 12:49:28 2009
BIOS Version	v1.02
Firmware Version	v1.15
Hardware-Mechanical Version	v1.01 - v1.01
Serial Number	031F03000003
Host IP Address	192.168.2.25
Host MAC Address	00-40-C7-F8-00-E5
Device Port	UART * 1 TP *24 Fiber * 2
RAM Size	32 M
Flash Size	4 M
CPU Load	6 %

Apply

Fig. 3-3.1 System information

Parameter description:

Model name:

The model name of this device.

System description:

As it is, this tells what this device is. Here, it is "24 Fast Ethernet + 2 Gigabit L2 Managed Switch".

Location:

Basically, it is the location where this switch is put. User-defined.

Contact:

For easily managing and maintaining device, you may write down the contact person and phone here for getting help soon. You can configure this parameter through the device's user interface or SNMP.

Device name:

The name of the switch. User-defined. Default is MSM-6226.

System up time:

The time accumulated since this switch is powered up. Its format is day, hour, minute, second.

Current time:

Show the system time of the switch. Its format: day of week, month, day, hours : minutes : seconds, year. For instance, Tue Apr 20 23:25:58 2004

BIOS version:

The version of the BIOS in this switch.

Firmware version:

The firmware version in this switch.

Hardware-Mechanical version:

The version of Hardware and Mechanical. The figure before the hyphen is the version of electronic hardware; the one after the hyphen is the version of mechanical.

Serial number:

The serial number is assigned by the Manufacturer.

Host IP address:

The IP address of the switch.

Host MAC address:

It is the Ethernet MAC address of the management agent in this switch.

Device Port:

Show all types and numbers of the port in the switch.

RAM size:

The size of the DRAM in this switch.

Flash size:

The size of the flash memory in this switch.

CPU Loading:

The loading of the CPU on this switch.

3-1-2. IP Configuration

IP configuration is one of the most important configurations in the switch. Without the proper setting, network manager will not be able to manage or view the device. The switch supports both manual IP address setting and automatic IP address setting via DHCP server. When IP address is changed, you must reboot the switch to have the setting taken effect and use the new IP to browse for web management and CLI management.

Function name:

IP Configuration

Function description:

Set IP address, subnet mask, default gateway and DNS for the switch.

IP Configuration

DHCP Setting	Disable
IP Address	192.168.2.25
Subnet Mask	255.255.255.0
Default Gateway	192.168.2.254
DNS Server	Manual 0.0.0.0

Apply

Fig. 3-4 IP Address Configuration

Parameter description:

DHCP Setting:

DHCP is the abbreviation of Dynamic Host Configuration Protocol. Here DHCP means a switch to turn ON or OFF the function.

The switch supports DHCP client used to get an IP address automatically if you set this function "Enable". When enabled, the switch will issue the request to the DHCP server resided in the network to get an IP address. If DHCP server is down or does not exist, the switch will issue the request and show IP address is under requesting, until the DHCP server is up. Before getting an IP address from DHCP server, the device will not continue booting procedures. If set this field "Disable", you'll have to input IP address manually. For more details about IP address and DHCP, please see the Section 2-1-5 "IP Address Assignment" in this manual.

Default: Disable

IP address:

Users can configure the IP settings and fill in new values if users set the DHCP function "Disable". Then, click **<Apply>** button to update.

When DHCP is disabled, Default: 192.168.1.1

If DHCP is enabled, this field is filled by DHCP server and will not allow user manually set it any more.

Subnet mask:

Subnet mask is made for the purpose to get more network address because any IP device in a network must own its IP address, composed of Network address and Host address, otherwise can't communicate with other devices each other. But unfortunately, the network classes A, B, and C are all too large to fit for almost all networks, hence, subnet mask is introduced to solve this problem. Subnet mask uses some bits from host address and makes an IP address looked Network address, Subnet mask number and host address. It is shown in the following figure. This reduces the total IP number of a network able to support, by the amount of 2 power of the bit number of subnet number ($2^{(\text{bit number of subnet number})}$).

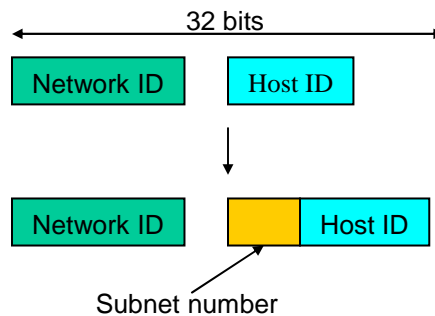

Subnet mask is used to set the subnet mask value, which should be the same value as that of the other devices resided in the same network it attaches.

For more information, please also see the Section 2-1-5 "IP Address Assignment" in this manual.

Default: 255.255.255.0

Default gateway:

Set an IP address for a gateway to handle those packets that do not meet the routing rules predefined in the device. If a packet does not meet the criteria for other pre-defined path, it must be forwarded to a default router on a default path. This means any packet with undefined IP address in the routing table will be sent to this device unconditionally.

Default: 192.168.1.254

DNS:

It is Domain Name Server used to serve the translation between IP address and name address.

The switch supports DNS client function to re-route the mnemonic name address to DNS server to get its associated IP address for accessing Internet. User can specify a DNS IP address for the switch. With this, the switch can translate a mnemonic name address into an IP address.

There are two ways to specify the IP address of DNS. One is fixed mode, which manually specifies its IP address, the other is dynamic mode, which is assigned by DHCP server while DHCP is enabled. DNS can help you easily remember the mnemonic address name with the meaningful words in it. Default is no assignment of DNS address.

Default: 0.0.0.0

3-1-3. Time Configuration

The switch provides manual and automatic ways to set the system time via NTP. Manual setting is simple and you just input “Year”, “Month”, “Day”, “Hour”, “Minute” and “Second” within the valid value range indicated in each item. If you input an invalid value, for example, 61 in minute, the switch will clamp the figure to 59.

NTP is a well-known protocol used to synchronize the clock of the switch system time over a network. NTP, an internet draft standard formalized in RFC 1305, has been adopted on the system is version 3 protocol. The switch provides four built-in NTP server IP addresses resided in the Internet and an user-defined NTP server IP address. The time zone is Greenwich-centered which uses the expression form of GMT+/- xx hours.

Function name:

Time

Function description:

Set the system time by manual input or set it by syncing from Time servers. The function also supports daylight saving for different area’s time adjustment.

System Time Setting

Current Time		Sat Mar 23 21:49:36 2002						
<input checked="" type="radio"/> Manual	Year	2002	(2000~2036)	Month	3	(1~12)		
	Day	23	(1~31)	Hour	21	(0~23)		
	Minute	49	(0~59)	Second	36	(0~59)		
<input type="radio"/> NTP	<input checked="" type="radio"/> 209.81.9.7(USA) <input type="radio"/> 137.189.8.174(HK) <input type="radio"/> 133.100.9.2(JP) <input type="radio"/> 131.188.3.222(Germany) <input type="radio"/> 209.81.9.7				Time Zone GMT+8:00			
	Daylight Saving 0							
Daylight Saving Start			Mth	1	Day	1	Hour	0
Daylight Saving End			Mth	1	Day	1	Hour	0

Apply

Fig. 3-5

Parameter description:

Current Time:

Show the current time of the system.

Manual:

This is the function to adjust the time manually. Filling the valid figures in the fields of Year, Month, Day, Hour, Minute and Second respectively and press **<Apply>** button, time is adjusted. The valid figures for the parameter Year, Month, Day, Hour, Minute and Second are ≥ 2000 , 1-12, 1-31, 0-23, 0-59 and 0-59 respectively. Input the wrong figure and press **<Apply>** button, the device will reject the time adjustment request. There is no time zone setting in Manual mode.

Default: Year = 2000, Month = 1, Day = 1
Hour = 0, Minute = 0, Second = 0

NTP:

NTP is Network Time Protocol and is used to sync the network time based Greenwich Mean Time (GMT). If use the NTP mode and select a built-in NTP time server or manually specify an user-defined NTP server as well as Time Zone, the switch will sync the time in a short after pressing **<Apply>** button. Though it synchronizes the time automatically, NTP does not update the time periodically without user's processing.

Time Zone is an offset time off GMT. You have to select the time zone first and then perform time sync via NTP because the switch will combine this time zone offset and updated NTP time to come out the local time, otherwise, you will not able to get the correct time. The switch supports configurable time zone from -12 to $+13$ step 1 hour.

Default Time zone: +8 Hrs.

Daylight Saving:

Daylight saving is adopted in some countries. If set, it will adjust the time lag or in advance in unit of hours, according to the starting date and the ending date. For example, if you set the day light saving to be 1 hour. When the time passes over the starting time, the system time will be increased one hour after one minute at the time since it passed over. And when the time passes over the ending time, the system time will be decreased one hour after one minute at the time since it passed over.

The switch supports valid configurable day light saving time is $-5 \sim +5$ step one hour. The zero for this parameter means it need not have to adjust current time, equivalent to in-act daylight saving. You don't have to set the starting/ending date as well. If you set daylight saving to be non-zero, you have to set the starting/ending date as well; otherwise, the daylight saving function will not be activated.

Default for Daylight Saving: 0.

The following parameters are configurable for the function Daylight Saving and described in detail.

Day Light Saving Start :

This is used to set when to start performing the day light saving time.

Mth:

Range is 1 ~ 12.

Default: 1

Day:

Range is 1 ~ 31.

Default: 1

Hour:

Range is 0 ~ 23.

Default: 0

Day Light Saving End :

This is used to set when to stop performing the daylight saving time.

Mth:

Range is 1 ~ 12.

Default: 1

Day:

Range is 1 ~ 31.

Default: 1

Hour:

Range is 0 ~ 23.

Default: 0

3-1-4. Account Configuration

In this function, only administrator can create, modify or delete the username and password. Administrator can modify other guest identities' password without confirming the password but it is necessary to modify the administrator-equivalent identity. Guest-equivalent identity can modify his password only. Please note that you must confirm administrator/guest identity in the field of Authorization in advance before configuring the username and password. Only one administrator is allowed to exist and unable to be deleted. In addition, up to 4 guest accounts can be created.

The default setting for user account is:

Username : admin

Password : admin

The default setting for guest user account is:

Username : guest

Password : guest

Account Configuration

Account Name	Authorization
admin	Administrator
operator	Operator
guest	Guest



Fig. 3-6

3-1-5. Management Security

Through the management security configuration, the manager can do the strict setup to control the switch and limit the user to access this switch.

The following rules are offered for the manager to manage the switch:

Rule 1) : When no lists exists, then it will accept all connections.

Accept

Rule 2) : When only “accept lists” exist, then it will deny all connections, excluding the connection inside of the accepting range.

Accept Deny **Accept** Deny **Accept**

Rule 3) : When only “deny lists” exist, then it will accept all connections, excluding the connection inside of the denying range.

Deny Accept **Deny** Accept **Deny**

Rule 4) : When both “accept and deny” lists exist, then it will deny all connections, excluding the connection inside of the accepting range.

Accept Deny **Deny** Deny **Accept**

Rule 5) : When both “accept and deny” lists exist, then it will deny all connections, excluding the connection inside of the accepting range and NOT inside of the denying range at the same time.

Accept	
	Deny

Accept

Deny| Acc | Deny | Acc | Deny

Function name:

Management Security Configuration

Function description:

The switch offers Management Security Configuration function. With this function, the manager can easily control the mode that the user connects to the switch. According to the mode, users can be classified into two types: Those who are able to connect to the switch (Accept) and those who are unable to connect to the switch (Deny). Some restrictions also can be placed on the mode that the user connect to the switch, for example, we can decide that which VLAN VID is able to be accepted or denied by the switch, the IP range of the user could be accepted or denied by the switch, the port that the user is allowed or not allowed to connect with the switch, or the way of controlling and connecting to the switch via Http, Telnet or SNMP.

Management Security Configuration

Name	VID	IP Range
<input type="text"/>	<input checked="" type="checkbox"/> Any Custom: <input type="text"/>	<input checked="" type="checkbox"/> Any Custom: <input type="text"/> -- <input type="text"/>

Incoming Port	Access Type	Action
<input checked="" type="checkbox"/> Any Custom: 1. <input type="checkbox"/> 2. <input type="checkbox"/> 3. <input type="checkbox"/> 4. <input type="checkbox"/> 5. <input type="checkbox"/> 6. <input type="checkbox"/> 7. <input type="checkbox"/> 8. <input type="checkbox"/> 9. <input type="checkbox"/> 10. <input type="checkbox"/> 11. <input type="checkbox"/> 12. <input type="checkbox"/> 13. <input type="checkbox"/> 14. <input type="checkbox"/> 15. <input type="checkbox"/> 16. <input type="checkbox"/> 17. <input type="checkbox"/> 18. <input type="checkbox"/> 19. <input type="checkbox"/> 20. <input type="checkbox"/> 21. <input type="checkbox"/> 22. <input type="checkbox"/> 23. <input type="checkbox"/> 24. <input type="checkbox"/> 25. <input type="checkbox"/> 26. <input type="checkbox"/>	<input checked="" type="checkbox"/> Any Custom: <input type="checkbox"/> Http <input type="checkbox"/> Telnet <input type="checkbox"/> SNMP	<input checked="" type="radio"/> Deny <input type="radio"/> Accept

No	Name	VID	IP Range	Incoming Port	Access Type	Action
----	------	-----	----------	---------------	-------------	--------

Fig. 3-7

Parameter description:

Name:

A name is composed of any letter (A-Z, a-z) and digit (0-9) with maximal 8 characters.

VID:

The switch supports two kinds of options for managed valid VLAN VID, including "Any" and "Custom". Default is "Any". When you choose "Custom", you can fill in VID number. The valid VID range is 1~4094.

IP Range:

The switch supports two kinds of options for managed valid IP Range, including "Any" and "Custom". Default is "Any". In case that "Custom" had been chosen, you can assigned effective IP range. The valid range is 0.0.0.0~255.255.255.255.

Incoming Port:

The switch supports two kinds of options for managed valid Port Range, including "Any" and "Custom". Default is "Any". You can select the ports that you would like them to be worked and restricted in the management security configuration if "Custom" had been chosen.

Access Type:

The switch supports two kinds of options for managed valid Access Type, including "Any" and "Custom". Default is "Any". "Http", "Telnet" and "SNMP" are three ways for the access and managing the switch in case that "Custom" had been chosen.

Action:

The switch supports two kinds of options for managed valid Action Type, including "Deny" and "Accept". Default is "Deny". When you choose "Deny" action, you will be restricted and refused to manage the switch due to the "Access Type" you choose. However, while you select "Accept" action, you will have the authority to manage the switch.

Edit/Create:

A new entry of Management Security Configuration can be created after the parameters as mentioned above had been setup and then press **<Edit/Create>** button. Of course, the existed entry also can be modified by pressing this button.

Delete:

Remove the existed entry of Management Security Configuration from the management security table.

3-1-6. Virtual Stack

Function name:

Virtual Stack

Function description:

Virtual Stack Management(VSM) is the group management function. Through the proper configuration of this function, switches in the same LAN will be grouped automatically. And among these switch, one switch will be a master machine, and the others in this group will become the slave devices.

VSM offers a simple centralized management function. It is not necessary to remember the address of all devices, manager is capable of managing the network with knowing the address of the Master machine. Instead of SNMP or Telnet UI, VSM is only available in Web UI. While one switch become the Master, two rows of buttons for group device will appear on the top of its Web UI. By pressing these buttons, user will be allowed to connect the Web UI of the devices of the group in the same window without the login of these device.

The most top-left button is only for Master device(See Fig.3-9). The background color of the button you press will be changed to represent that the device is under your management.

The device of the group will be shown as station address (the last number of IP Address) + device name on the button (e.g. 196_ MSM-6226), otherwise it will show " ---- " if no corresponding device exists.

Once the devices join the group successfully, then they are merely able to be managed via Master device, and user will fail to manage them via telnet/console/web individually.

Up to 16 devices can be grouped for VSM, however, only one Master is allowed to exist in each group. For Master redundancy, user may configure more than two devices as Master device, however, the Master device with the smaller MAC value will be the Master one. All of these 16 devices can become Master device and back up with each other .

Virtual Stack Configuration

State	Enable
Role	Master
Group ID	default

Apply

Note: You should be logout every time when you change the state of Virtual Stack.

Fig. 3-8

Parameter description:

State:

It is used for the activation or de-activation of VSM. Default is Enable.

Role:

The role that the switch would like to play in virtual stack. Two types of roles, including master and slave are offered for option. Default is Master.

Group ID:

It is the group identifier (GID) which signs for VSM. Valid letters are A-Z, a-z, 0-9, “ - “ and “ _ ” characters. The maximal length is 15 characters.

The screenshot displays a network management interface. At the top, a table shows port configurations for a switch named '25_FEL2P-S'. Below this is a photograph of the physical switch. On the left, a navigation menu lists various system settings, with 'Virtual Stack' highlighted. On the right, a 'System Information' window is open, showing details for the 'FEL2P-SW26' model.

Port	Mode	Speed	Flow Control	Port Security	STP	Link Agg	QoS
25_FEL2P-S	-----	-----	-----	-----	-----	-----	-----

System Information	
Model Name	FEL2P-SW26
System Description	24-Port L2 Plus Managed Fast Ethernet Switch + 2 TP/SFP Gigabit Dual Media
Location	
Contact	
Device Name	FEL2P-SW26

Fig. 3-9

3-2. DHCP Snooping

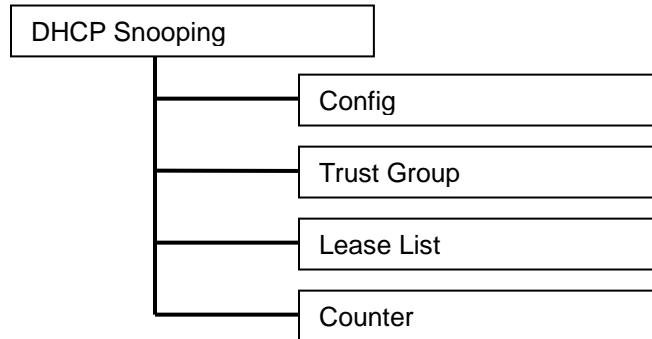

Fig.3-9-1

3-2-1. DHCP Snooping Config

Function name:

DHCP Snooping Config

Function description:

The addresses assigned to DHCP clients on unsecure ports can be carefully controlled using the dynamic bindings registered with DHCP Snooping. DHCP snooping allows a switch to protect a network from rogue DHCP servers or other devices which send port-related information to a DHCP server. This information can be useful in tracking an IP address back to a physical port.

DHCP Snooping Config	
State	Disable
Per Port Client Count Setup	
Port	Count
1	128
2	128
3	128
4	128
5	128
6	128
7	128
8	128

Fig. 3-10

Parameter description:

State:

It is used for the activation or de-activation of DHCP Snooping. Default is disable.

Per Port Client Count Setup:

The limitation per port client count setup. If the current client count was lower than the value which you set on switch then the link will be keep. The maximum is 512 and default is 128.

3-2-2. Trust Group

Function name:

Trust Group

Function description:

The function which you can configure the Group as trusted or untrusted. You must to set the trust port1 and port2 on the Switch, Option 82 state with “ Disable”/ “Enable”, Action with “Replace”/ “Drop” /” Keep” , DHCP Server VLAN ID, DHCP Server IP address. and Trust VID.

DHCP Snooping Trust Group Config

Trust VID	Server Port	Server VID	DHCP Server IP	Option 82	Action
(None)					

Delete

Server Port 1	Disable	Server Port 2	Disable
Option 82	Disable	Action	Replace
Server VID		Server IP	0.0.0.0
Trust VID			

Edit/Create

Default Group			
Server Port 1	Disable	Server Port 2	Disable
Option 82	Disable	Action	Keep
Server VID	1	Server IP	0.0.0.0

Apply

Fig. 3-10.1

Parameter description:

Server Port1, 2:

To configure the port which DHCP Server connect to on the Switch.

Option 82:

To enable or disable the DHCP Option 82 function on the Switch.

Action:

When switch receive the packet with Option 82 then action with “ Replace”, “ Drop” or “Keep. It need to coordinate with Option 82.

Server VID:

The DHCP Server belong the VLAN member ID which you set on the Switch. ;Obey by the PVID on the Switch.

Server IP:

The DHCP Server IP address. It allows the IP address with 0.0.0.0.

Trust VID:

The DHCP client belong the VLAN member ID which you set on the Switch. It can be different with server VID; Obey by the PVID on the Switch.

Edit/ Create:

It allows you to edit or create a DHCP snooping trust group rule on the switch.

Delete:

To delete a DHCP snooping trust group entry on the switch.

Apply:

To save the configuration to the switch.

3-2-3. Lease List

Function name:

Lease List

Function description:

To record and display the DHCP Snooping concurrent lease List table.

DHCP Snooping Lease List

MAC	IP	Port	VID	Lease (Day:Hour:Min:Sec)
(None)				

Fig. 3-10.2

Parameter description:

MAC:

To display the DHCP server Client MAC address.

IP:

To display the client's IP address which got from the DHCP server.

Port:

To display the client belong the port on the switch.

VID:

To display the client belong the VLAN member ID on the switch.

Lease:

To display the client lease time state, includes Day.Hour:Min:Sec.

3-2-4. Counter

Function name:

Counter

Function description:

To display the DHCP Snooping packet received per port detail counter information. .

DHCP Snooping Counter

Refresh Interval

Port No	Discovery	Offer	Request	Decline	Ack	Nack	Release	Inform
1	1	1	1	0	1	0	0	0
2	0	0	0	0	0	0	0	0
3	0	0	0	0	0	0	0	0
4	0	0	0	0	0	0	0	0
5	0	0	0	0	0	0	0	0
6	0	0	0	0	0	0	0	0
7	0	0	0	0	0	0	0	0
8	0	0	0	0	0	0	0	0
9	0	0	0	0	0	0	0	0
10	0	0	0	0	0	0	0	0
11	0	0	0	0	0	0	0	0
12	0	0	0	0	0	0	0	0
13	0	0	0	0	0	0	0	0

Fig. 3-10.2

Parameter description:

Port No:

The port number on the switch. .

Discovery:

To display discovery of DHCP request packet received by the port on the switch .

3-3. DHCP Relay

The Dynamic Host Configuration Protocol (DHCP) is a service that runs at the application layer of the TCP/IP protocol stack to dynamically assign IP addresses to DHCP clients. DHCP clients request IP addresses, and obtain leases for IP addresses from the DHCP server.

The DHCP Relay Agent makes it possible for DHCP broadcast messages to be sent over routers that do not support forwarding of these types of messages. The DHCP Relay Agent is therefore the routing protocol that enables DHCP clients to obtain IP addresses from a DHCP server on a remote subnet, or which is not located on the local subnet. If you have no configured DHCP Relay Agent, your clients would only be able to obtain IP addresses from the DHCP server which is on the same subnet.

If you are using the switches to insert DHCP Option 82 information and you are also using as DHCP relay-agents (via 'ip helper-address'), you'll notice right away that your Option 82 enabled DHCP requests are not being forwarded by your switches.

Function name:

Config

Function description:

The switch to enable clients to obtain IP addresses from a DHCP server on a remote subnet, you have to configure the DHCP Relay Agent on the subnet that contains the remote clients, so that it can relay DHCP broadcast messages to your DHCP server.

DHCP Relay

DHCP Relay State	Disable ▾
DHCP Relay LifeTime	5 ▾ seconds
DHCP Relay Agent Information Option82 State	Disable ▾
DHCP Relay Agent Information Option82 Policy	Keep ▾
Server Port	1. <input type="checkbox"/> 2. <input type="checkbox"/> 3. <input type="checkbox"/> 4. <input type="checkbox"/> 5. <input type="checkbox"/> 6. <input type="checkbox"/> 7. <input type="checkbox"/> 8. <input type="checkbox"/> 9. <input type="checkbox"/> 10. <input type="checkbox"/> 11. <input type="checkbox"/> 12. <input type="checkbox"/> 13. <input type="checkbox"/> 14. <input type="checkbox"/> 15. <input type="checkbox"/> 16. <input type="checkbox"/> 17. <input type="checkbox"/> 18. <input type="checkbox"/> 19. <input type="checkbox"/> 20. <input type="checkbox"/> 21. <input type="checkbox"/> 22. <input type="checkbox"/> 23. <input type="checkbox"/> 24. <input type="checkbox"/> 25. <input type="checkbox"/> 26. <input type="checkbox"/>
Server IP	0.0.0.0

Apply

Fig. 3-13-1

Parameters description:

DHCP Relay State:

To enable or disable the DHCP Relay function on the Switch, Default is **“Disable”**.

DHCP Relay Lifetime:

Use to set the default lifetime for which a prefix delegated by this DHCP local server is valid. This default is overridden by an interface-specific lifetime. Default is **“5”** sec.

DHCP Relay Agent Information Option 82 state:

Enables the system to insert the DHCP relay agent information option 82 in forwarded BOOT REQUEST messages to a DHCP server.

Default is **“Disable”** sec.

DHCP Relay Agent Information Option 82 Policy:

A DHCP relay agent may receive a message from another DHCP relay agent that already contains relay information. If this behavior is not suitable for your network, you can use the command **“Replace, keep , Drop”** to change it.

Default is **“Keep”** sec.

Server Port:

To evoke which port will enable the DHCP Relay Agent service.

Server IP:

To set the DHCP Server IP address.

3-4. IP-MAC Binding

The IP network layer uses a four-byte address. The Ethernet link layer uses a six-byte MAC address. Binding these two address types together allows the transmission of data between the layers. The primary purpose of IP-MAC binding is to restrict the access to a switch to a number of authorized users. Only the authorized client can access the Switch's port by checking the pair of IP-MAC Addresses and port number with the pre-configured database. If an unauthorized user tries to access an IP-MAC binding enabled port, the system will block the access by dropping its packet.

Function name:

IP MAC Binding Configuration

Function description:

The switch has client and server two classes of IP-MAC Binding table. The maximum number of IP-MAC binding client table is 512 entries. The maximum number of IP-MAC Binding server table is 64 entries. The creation of authorized users can be manually. The function is global, this means a user can enable or disable the function for all ports on the switch.

IP-MAC-Binding

Mode	Disable ▾																																																			
Binding Port	1.	<input checked="" type="checkbox"/>	2.	<input checked="" type="checkbox"/>	3.	<input checked="" type="checkbox"/>	4.	<input checked="" type="checkbox"/>	5.	<input checked="" type="checkbox"/>	6.	<input checked="" type="checkbox"/>	7.	<input checked="" type="checkbox"/>	8.	<input checked="" type="checkbox"/>	9.	<input checked="" type="checkbox"/>	10.	<input checked="" type="checkbox"/>	11.	<input checked="" type="checkbox"/>	12.	<input checked="" type="checkbox"/>	13.	<input checked="" type="checkbox"/>	14.	<input checked="" type="checkbox"/>	15.	<input checked="" type="checkbox"/>	16.	<input checked="" type="checkbox"/>	17.	<input checked="" type="checkbox"/>	18.	<input checked="" type="checkbox"/>	19.	<input checked="" type="checkbox"/>	20.	<input checked="" type="checkbox"/>	21.	<input checked="" type="checkbox"/>	22.	<input checked="" type="checkbox"/>	23.	<input checked="" type="checkbox"/>	24.	<input checked="" type="checkbox"/>	25.	<input type="checkbox"/>	26.	<input type="checkbox"/>

Fig. 3-11

Parameters description:

State:

mode: It is used for the activation or de-activation of IP-MAC Binding. Default is disable.

Binding Port: It are the ports which signs for IP-MAC Binding.

Binding List:

The maximum number of IP-MAC binding client table is 512 entries. The maximum number of IP-MAC Binding server table is 64 entries.

Name:

A name is composed of any letter (A-Z, a-z) and digit (0-9) with maximal 8 characters.

MAC:

Six-byte MAC Address: xx-xx-xx-xx-xx-xx

For example: 00-40-c7-00-00-01

IP:

Four-byte IP Address: xxx.xxx.xxx.xxx

For example: 192.168.1.100

Port No:

Port no.: 1-24

Add:

Input MAC, IP, Port and VID, then click on <Add> to create a new entry into the IP MAC Binding table

Edit:

The existed entry also can be modified after pressing <Edit> button.

Delete:

Select one of entry from the table, then click on <Delete> to delete this entry.

Current User List

No	Name	MAC	IP	Method	Type
Delete <input type="checkbox"/>	Binding Ports				
IP-MAC Binding is disabled					

Fig. 3-12

3-5. Port Configuration

Four functions, including Port Status, Port Configuration, Simple Counter and Detail Counter are contained in this function folder for port monitor and management. Each of them will be described in detail orderly in the following sections.

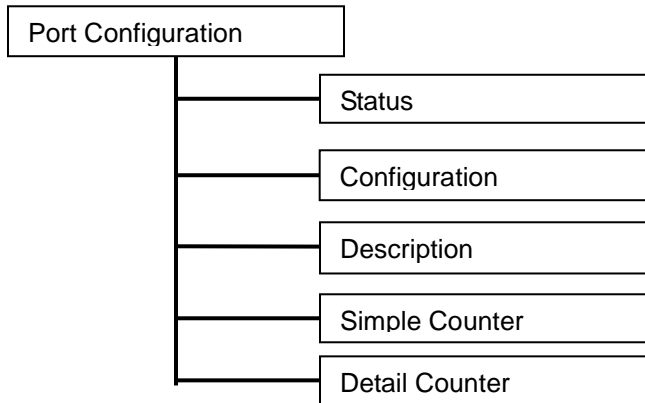

3-5-1.Port Status

The function Port Status gathers the information of all ports' current status and reports it by the order of port number, media, link status, port state, Auto-Negotiation status, speed/duplex, Rx Pause and Tx Pause. An extra media type information for the module ports 25 and 26 is also offered (See Fig. 3-11).

Port Current Status

Port No	Media	Link	State	Auto Nego.	Speed/Duplex	Rx Pause	Tx Pause	Port Description
1	TP	Up	Enabled	Enabled	100M/Full	On	On	
2	TP	Down	Enabled	Enabled	---/----	-----	-----	
3	TP	Down	Enabled	Enabled	---/----	-----	-----	
4	TP	Down	Enabled	Enabled	---/----	-----	-----	
5	TP	Down	Enabled	Enabled	---/----	-----	-----	
6	TP	Down	Enabled	Enabled	---/----	-----	-----	
7	TP	Down	Enabled	Enabled	---/----	-----	-----	
8	TP	Down	Enabled	Enabled	---/----	-----	-----	

Fig. 3-13

Function name:

Port Status

Function Description:

Report the latest updated status of all ports in this switch. When any one of the ports in the switch changes its parameter displayed in the page, it will be automatically refreshed the port current status about every 5 seconds.

Parameter Description:

Port No:

Display the port number. The number is 1 – 26. Both port 25 and 26 are optional modules.

Media:

Show the media type adopted in all ports. The Port 25 and Port 26 are optional modules, which support either fiber or UTP media with either Gigabit Ethernet (1000Mbps) or 10/100Mbps Fast Ethernet port. They may have different media types and speed. Especially, fiber port has comprehensive types of connector, distance, fiber mode and so on. The switch describes the module ports with the following page.

Link:

Show that if the link on the port is active or not. If the link is connected to a working-well device, the Link will show the link “Up”; otherwise, it will show “Down”. This is determined by the hardware on both devices of the connection.

No default value.

State:

Show that the communication function of the port is “Enabled” or “Disabled”. When it is enabled, traffic can be transmitted and received via this port. When it is disabled, no traffic can be transferred through this port. Port State is configured by user.

Default: Enabled.

Auto Nego.:

Show the exchange mode of Ethernet MAC. There are two modes supported in the switch. They are auto-negotiation mode “Enabled” and forced mode “Disabled”. When in “Enabled” mode, this function will automatically negotiate by hardware itself and exchange each other the capability of speed and duplex mode with other site which is linked, and comes out the best communication way. When in “Disabled” mode, both parties must have the same setting of speed and duplex, otherwise, both of them will not be linked. In this case, the link result is “Down”.

Default: Enabled

Speed / Duplex :

Display the speed and duplex of all port. There are three speeds 10Mbps, 100Mbps and 1000Mbps supported for TP media, and the duplex supported is half duplex and full duplex. If the media is 1Gbps fiber, it is 1000Mbps supported only. The status of speed/duplex mode is determined by 1) the negotiation of both local port and link partner in “Auto Speed” mode or 2) user setting in “Force” mode. The local port has to be preset its capability.

In port 1 – 24, they are supported Fast Ethernet with TP media only, so the result will show 100M/Full or 100M/Half, 10M/Full and 10M/Half duplex.

In port 25 and port 26, if the media is 1000Mbps with TP media, it will show the combinations of 10/100M and Full/Half duplex, 1000Mbps and Full duplex only. If the media is 1000Mbps with fiber media, it will show only 1000M/Full duplex.

Default: None, depends on the result of the negotiation.

Rx Pause:

The way that the port adopts to process the PAUSE frame. If it shows “on”, the port will care the PAUSE frame; otherwise, the port will ignore the PAUSE frame.

Default: None

Tx Pause:

It decides that whether the port transmits the PAUSE frame or not. If it shows “on”, the port will send PAUSE frame; otherwise, the port will not send the PAUSE frame.

Default: None



Fig. 3-14

Parameter description of Port 25 and Port 26:

Connector Type:

Display the connector type, for instance, UTP, SC, ST, LC and so on.

Fiber Type:

Display the fiber mode, for instance, Multi-Mode, Single-Mode.

Tx Central Wavelength:

Display the fiber optical transmitting central wavelength, for instance, 850nm, 1310nm, 1550nm and so on.

Baud Rate:

Display the maximum baud rate of the fiber module supported, for instance, 10M, 100M, 1G and so on.

Vendor OUI:

Display the Manufacturer's OUI code which is assigned by IEEE.

Vendor Name:

Display the company name of the module Manufacturer.

Vendor P/N:

Display the product name of the naming by module Manufacturer.

Vendor Rev (Revision):

Display the module revision.

Vendor SN (Serial Number):

Show the serial number assigned by the Manufacturer.

Date Code:

Show the date this module was made.

Temperature:

Show the current temperature of module.

Vcc:

Show the working DC voltage of module.

Mon1(Bias) mA:

Show the Bias current of module.

Mon2(TX PWR):

Show the transmit power of module.

Mon3(RX PWR):

Show the receiver power of module.

3-5-2. Port Configuration

Port Configuration is applied to change the setting of each port. In this configuration function, you can set/reset the following functions. All of them are described in detail below.

Function name:

Port Configuration

Function description:

It is used to set each port's operation mode. The switch supports 3 parameters for each port. They are State, Speed/Duplex and Flow Control.

Port Configuration

Port No	State	Speed/Duplex	Flow Control	Power Saving
1	Enable	Auto	Symmetric	Disable
2	Enable	Auto	Symmetric	Disable
3	Enable	Auto	Symmetric	Disable
4	Enable	Auto	Symmetric	Disable
5	Enable	Auto	Symmetric	Disable
6	Enable	Auto	Symmetric	Disable
7	Enable	Auto	Symmetric	Disable
8	Enable	Auto	Symmetric	Disable
9	Enable	Auto	Symmetric	Disable
10	Enable	Auto	Symmetric	Disable
11	Enable	Auto	Symmetric	Disable
12	Enable	Auto	Symmetric	Disable
13	Enable	Auto	Symmetric	Disable
14	Enable	Auto	Symmetric	Disable
15	Enable	Auto	Symmetric	Disable
16	Enable	Auto	Symmetric	Disable
17	Enable	Auto	Symmetric	Disable
18	Enable	Auto	Symmetric	Disable
19	Enable	Auto	Symmetric	Disable
20	Enable	Auto	Symmetric	Disable
21	Enable	Auto	Symmetric	Disable
22	Enable	Auto	Symmetric	Disable
23	Enable	Auto	Symmetric	Disable
24	Enable	Auto	Symmetric	Disable
25	Enable	Auto	Symmetric	Disable
26	Enable	Auto	Symmetric	Disable

Apply

Fig. 3-15

Parameter description:

State:

Set the communication capability of the port is Enabled or Disabled. When enabled, traffic can be transmitted and received via this port. When disabled, the port is blocked and no traffic can be transferred through this port. Port State is configurable by the user. There are only two states “Enable” and “Disable” able to choose. If you set a port’s state “Disable”, then that port is prohibited to pass any traffic, even it looks Link up.

Default: Enable.

Speed/Duplex:

Set the speed and duplex of the port. In speed, 10/100Mbps baud rate is available for Fast Ethernet, Gigabit module in port 25, 26. If the media is 1Gbps fiber, it is always 1000Mbps and the duplex is full only. If the media is TP, the Speed/Duplex is comprised of the combination of speed mode, 10/100/1000Mbps, and duplex mode, full duplex and half duplex. The following table summarized the function the media supports.

Media type	NWay	Speed	Duplex
100M TP	ON/OFF	10/100M	Full/Half
1000M TP	ON/OFF	10/100/1000M	Full for all, Half for 10/100
1000M Fiber	ON/OFF	1000M	Full

In Auto-negotiation mode, no default value. In Forced mode, default value depends on your setting.

Flow Control:

There are two modes to choose in flow control, including Symmetric and Asymmetric. If flow control is set Symmetric, both parties can send PAUSE frame to the transmitting device(s) if the receiving port is too busy to handle. When it is set Asymmetric, this will let the receiving port care the PAUSE frame from transmitting device(s), but it doesn’t send PAUSE frame. This is one-way flow control.

Default: Symmetric.

Power Saving:

The parameter will enable or disable to verify switches have the ability to consider the length of any Ethernet cable connected for adjustment of power usage accordingly. Shorter lengths require less power. link-down mode removes power for each port that does not have a device attached.

Default: Disable.

3-5-3. Port Description

Port Description is applied to change the setting of each port. In this configuration function, you can set the port description for specific application. All of them are described in detail below.

Function name:

Port Description

Function description:

It is used to set each port's description for network management purpose. You can assign the friendly description per port to identify the Port purpose.

Port Description

Port	Description
1	<input type="text"/>
2	<input type="text"/>
3	<input type="text"/>
4	<input type="text"/>
5	<input type="text"/>
6	<input type="text"/>

Fig. 3-15

Parameter description:

Port:

The port number on the Switch.

Description:

You can type the friendly description in the blank field. To set its port description, max 47 characters

3-5-4. Simple Counter

The function of Simple Counter collects any information and provides the counting about the traffic of the port, no matter the packet is good or bad.

In the Fig. 3-13, the window can show all ports' counter information at the same time. Each data field has 20-digit long. If the counting is overflow, the counter will be reset and restart counting. The data is updated every time interval defined by the user. The valid range is 3 to 10 seconds. The Refresh Interval is used to set the update frequency. Default update time is 3 seconds.

Function name:

Simple Counter

Function description:

Display the summary counting of each port's traffic, including Tx Byte, Rx Byte, Tx Packet, Rx Packet, Tx Collision and Rx Error Packet.

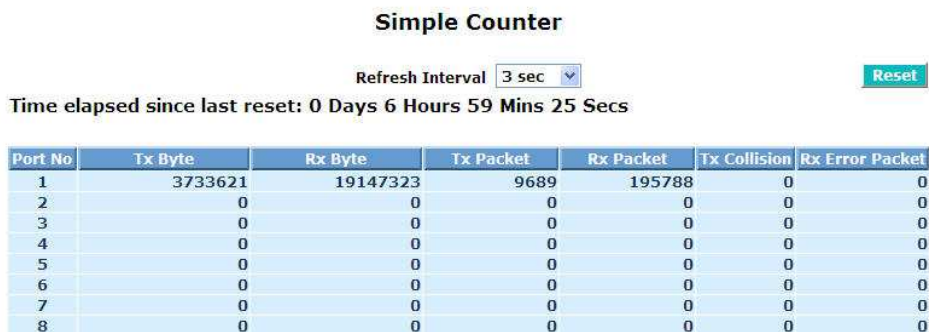

Fig. 3-16

Parameters description:

Tx Byte:

Total transmitted bytes.

Rx Byte:

Total received bytes.

Tx Packet:

The counting number of the packet transmitted.

Rx Packet:

The counting number of the packet received.

Tx Collision:

Number of collisions transmitting frames experienced.

Rx Error Packet:

Number of bad packets received.

3-5-5. Detail Counter

The function of Detail Counter collects any information and provides the counting about the traffic of the port, no matter the packet is good or bad.

In the Fig. 3-14, the window can show only one port counter information at the same time. To see another port's counter, you have to pull down the list of Select, then you will see the figures displayed about the port you had chosen.

Each data field has 20-digit long. If the counting is overflow, the counter will be reset and restart counting. The data is updated every time interval defined by the user. The valid range is 3 to 10 seconds. The Refresh Interval is used to set the update frequency. Default update time is 3 seconds.

Function name:

Detail Counter

Function description:

Display the detailed counting number of each port's traffic. In the Fig. 3-14, the window can show all counter information of each port at one time

Detail Counter

Select Port 1 Refresh Interval 3 sec Reset

Time elapsed since last reset: 0 Days 7 Hours 1 Mins 32 Secs

Receive Total		Transmit Error Counters	
Rx Packets	196974	Tx Collisions	0
Rx Octets	19263425	Tx Single Collision	0
Rx Errors	0	Tx Multiple Collision	0
Rx Unicast Packets	37432	Tx Drop Packets	0
Rx Broadcast Packets	132160	Tx Deferred Transmit	0
Rx Multicast Packets	27428	Tx Late Collision	0
Rx Pause Packets	0	Tx Excessive Collision	0
Receive Size Counters		Transmit Total	
Packets 64 Octets	92475	Tx Packets	9924
Packets 65 to 127 Octets	87680	Tx Octets	3841490
Packets 128 to 255 Octets	11869	Tx Unicast Packets	9924
Packets 256 to 511 Octets	2012	Tx Broadcast Packets	0
Packets 512 to 1023 Octets	2877	Tx Multicast Packets	0
Packets 1024 to 1522 Octets	107	Tx Pause Packets	0
Receive Error Counters			
Rx FCS Errors	0		
Rx Alignment Errors	0		

Fig. 3-17

Parameter description:

Rx Packets:

The counting number of the packet received.

Rx Octets:

Total received bytes.

Rx Errors:

Number of bad packets received.

Rx Unicast Packets:

Show the counting number of the received unicast packet.

Rx Broadcast Packets:

Show the counting number of the received broadcast packet.

Rx Multicast Packets:

Show the counting number of the received multicast packet.

Rx Pause Packets:

Show the counting number of the received pause packet.

Tx Collisions:

Number of collisions transmitting frames experienced.

Tx Single Collision:

Number of frames transmitted that experienced exactly one collision.

Tx Multiple Collision:

Number of frames transmitted that experienced more than one collision.

Tx Drop Packets:

Number of frames dropped due to excessive collision, late collision, or frame aging.

Tx Deferred Transmit:

Number of frames delayed to transmission due to the medium is busy.

Tx Late Collision:

Number of times that a collision is detected later than 512 bit-times into the transmission of a frame.

Tx Excessive Collision:

Number of frames that are not transmitted because the frame experienced 16 transmission attempts.

Packets 64 Octets:

Number of 64-byte frames in good and bad packets received.

Packets 65-127 Octets:

Number of 65 ~ 127-byte frames in good and bad packets received.

Packets 128-255 Octets:

Number of 128 ~ 255-byte frames in good and bad packets received.

Packets 256-511 Octets:

Number of 256 ~ 511-byte frames in good and bad packets received.

Packets 512-1023 Octets:

Number of 512 ~ 1023-byte frames in good and bad packets received.

Packets 1024- 1522 Octets:

Number of 1024-1522-byte frames in good and bad packets received.

Tx Packets:

The counting number of the packet transmitted.

TX Octets:

Total transmitted bytes.

Tx Unicast Packets:

Show the counting number of the transmitted unicast packet.

Tx Broadcast Packets:

Show the counting number of the transmitted broadcast packet.

Tx Multicast Packets:

Show the counting number of the transmitted multicast packet.

Tx Pause Packets:

Show the counting number of the transmitted pause packet.

Rx FCS Errors:

Number of bad FSC packets received.

Rx Alignment Errors:

Number of Alignment errors packets received.

Rx Fragments:

Number of short frames (< 64 bytes) with invalid CRC.

Rx Jabbers:

Number of long frames(according to max_length register) with invalid CRC.

Rx Drop Packets:

Frames dropped due to the lack of receiving buffer.

Rx Undersize Packets:

Number of short frames (<64 Bytes) with valid CRC.

Rx Oversize Packets:

Number of long frames(according to max_length register) with valid CRC.

3-6. Loop Detection

The loop detection is used to detect the presence of traffic. When switch receives packet's(looping detection frame) MAC address the same as oneself from port, show Loop detection happens. The port will be locked when it received the looping detection frames. If you want to resume the locked port, please find out the looping path and take off the looping path, then select the resume the locked port and click on "Resume" to turn on the locked ports

Function name:

Loop Detection

Function description:

Display whether switch open Loop detection.

Loop Detection

Port No	State	Current Status	Resume Action
1	Disable ▾	Unlocked	<input type="checkbox"/> Unlock
2	Disable ▾	Unlocked	<input type="checkbox"/> Unlock
3	Disable ▾	Unlocked	<input type="checkbox"/> Unlock
4	Disable ▾	Unlocked	<input type="checkbox"/> Unlock
5	Disable ▾	Unlocked	<input type="checkbox"/> Unlock
6	Disable ▾	Unlocked	<input type="checkbox"/> Unlock
7	Disable ▾	Unlocked	<input type="checkbox"/> Unlock
8	Disable ▾	Unlocked	<input type="checkbox"/> Unlock

Fig.3-18

Parameter description:

Port No:

Display the port number. The number is 1 – 24.

State – Disable / Enable:

When Port No is chosen, and enable port' s Loop detection, the port can detect loop happens. When Port-No is chosen, enable port' s Loop detection, and the port detects loop happen, port will be Locked. If Loop did not happen, port maintains Unlocked. The default is Disable.

Current Status:

Display the port current status. The default is unlocked.

Locked Port - Resume:

When Port No is chosen, enable port' s Loop detection, and the port detects loop happen, the port will be Locked. When choosing Resume, port locked will be opened and turned into unlocked. If not choosing Resume, Port maintains locked.

Action:

Option to enable the Loop-Detection function on the switch.

3-7. SNMP Configuration

Any Network Management System (NMS) running the Simple Network Management Protocol (SNMP) can manage the Managed devices equipped with SNMP agent, provided that the Management Information Base (MIB) is installed correctly on the managed devices. The SNMP is a protocol that is used to govern the transfer of information between SNMP manager and agent and traverses the Object Identity (OID) of the management Information Base (MIB), described in the form of SMI syntax. SNMP agent is running on the switch to response the request issued by SNMP manager.

Basically, it is passive except issuing the trap information. The switch supports a switch to turn on or off the SNMP agent. If you set the field SNMP "Enable", SNMP agent will be started up. All supported MIB OIDs, including RMON MIB, can be accessed via SNMP manager. If the field SNMP is set "Disable", SNMP agent will be de-activated, the related Community Name, Trap Host IP Address, Trap and all MIB counters will be ignored.

Function name:

SNMP Configuration

Function description:

This function is used to configure SNMP settings, community name, trap host and public traps as well as the throttle of SNMP. A SNMP manager must pass the authentication by identifying both community names, then it can access the MIB information of the target device. So, both parties must have the same community name. Once completing the setting, click **<Apply>** button, the setting takes effect.

SNMP Configuration

SNMP	<input checked="" type="radio"/> Enable <input type="radio"/> Disable		
Get Community	<input type="text" value="public"/>		
Set Community	<input type="text" value="private"/>	Enable ▾	
Trap Boot Delay Time	<input type="text" value="0"/>		
Trap Host 1 IP Address	<input type="text" value="0.0.0.0"/>	<input type="text" value="162"/>	Community <input type="text" value="public"/>
Trap Host 2 IP Address	<input type="text" value="0.0.0.0"/>	<input type="text" value="162"/>	Community <input type="text" value="public"/>
Trap Host 3 IP Address	<input type="text" value="0.0.0.0"/>	<input type="text" value="162"/>	Community <input type="text" value="public"/>
Trap Host 4 IP Address	<input type="text" value="0.0.0.0"/>	<input type="text" value="162"/>	Community <input type="text" value="public"/>
Trap Host 5 IP Address	<input type="text" value="0.0.0.0"/>	<input type="text" value="162"/>	Community <input type="text" value="public"/>
Trap Host 6 IP Address	<input type="text" value="0.0.0.0"/>	<input type="text" value="162"/>	Community <input type="text" value="public"/>

Fig. 3-19 Community and trap host setting

Parameters description:

SNMP:

The term SNMP here is used for the activation or de-activation of SNMP. Default is Enable.

Get/Set/Trap Community:

Community name is used as password for authenticating if the requesting network management unit belongs to the same community group. If they both don't have the same community name, they don't belong to the same group. Hence, the requesting network management unit can not access the device with different community name via SNMP protocol; If they both have the same community name, they can talk each other.

Community name is user-definable with a maximum length of 15 characters and is case sensitive. There is not allowed to put any blank in the community name string. Any printable character is allowable.

The community name for each function works independently. Each function has its own community name. Say, the community name for GET only works for GET function and can't be applied to other function such as SET and Trap.

Default SNMP function : Enable

Default community name for GET: public

Default community name for SET: private

Default community name for Trap: public

Default Set function : Enable

Default trap host IP address: 0.0.0.0

Default port number :162

Trap:

In the switch, there are 6 trap hosts supported. Each of them has its own community name and IP address; is user-definable. To set up a trap host means to create a trap manager by assigning an IP address to host the trap message. In other words, the trap host is a network management unit with SNMP manager receiving the trap message from the managed switch with SNMP agent issuing the trap message. 6 trap hosts can prevent the important trap message from losing.

For each public trap, the switch supports the trap event Cold Start, Warm Start, Link Down, Link Up and Authentication Failure Trap. They can be enabled or disabled individually. When enabled, the corresponded trap will actively send a trap message to the trap host when a trap happens. If all public traps are disabled, no public trap message will be sent. As to the Enterprise (no. 6) trap is classified as private trap, which are listed in the Trap Alarm Configuration function folder.

Default for all public traps: Enable.

3-8. DHCP Boot

The DHCP Boot function is used to spread the request broadcast packet into a bigger time frame to prevent the traffic congestion due to broadcast packets from many network devices which may seek its NMS, boot server, DHCP server and many connections predefined when the whole building or block lose the power and then reboot and recover. At this moment, a bunch of switch or other network device on the LAN will try its best to find the server to get the services or try to set up the predefined links, they will issue many broadcast packets in the network.

The switch supports a random delay time for DHCP and boot delay for each device. This suppresses the broadcast storm while all devices are at booting stage in the same time. The maximum user-defined delay time is 30 sec. If DHCP Broadcasting Suppression function is enabled, the delay time is set randomly, ranging from 0 to 30 seconds, because the exactly delay time is computed by the switch itself. The default is "Disable".



Fig. 3-20

3-9. Multicast

The function, is used to establish the multicast groups to forward the multicast packet to the member ports, and, in nature, avoids wasting the bandwidth while IP multicast packets are running over the network. This is because a switch that does not support IGMP or IGMP Snooping can not tell the multicast packet from the broadcast packet, so it can only treat them all as the broadcast packet. Without IGMP Snooping, the multicast packet forwarding function is plain and nothing is different from broadcast packet.

A switch supported IGMP Snooping with the functions of query, report and leave, a type of packet exchanged between IP Multicast Router/Switch and IP Multicast Host, can update the information of the Multicast table when a member (port) joins or leaves an IP Multicast Destination Address. With this function, once a switch receives an IP multicast packet, it will forward the packet to the members who joined in a specified IP multicast group before.

The packets will be discarded by the IGMP Snooping if the user transmits multicast packets to the multicast group that had not been built up in advance.

3-9-1. IGMP Setting

Function name:

IGMP Setting

Function description:

IGMP is used to snoop the status of IP multicast groups and display its associated information in both tagged VLAN and non-tagged VLAN networks. Enabling IGMP with either passive or active mode, you can monitor the IGMP snooping information, which contains the multicast member list with the multicast groups, VID and member port.

IGMP Setting

IGMP Snooping	<input checked="" type="checkbox"/>	Enable
Unregister Multicast Flooding	<input checked="" type="checkbox"/>	Enable
General Query Interval	125	(1 - 2000 sec)
General Query Max Response Time	10	(1 - 10 sec)
General Query Timeout	11	(1 - 30 sec)
Specific Query Count	2	(1 - 10 times)
Specific Query Max Response Time	1	(1 - 10 sec)
Specific Query Timeout	2	(1 - 30 sec)

Port	Multicast Group Limit	IGMP Router
1	256	<input type="checkbox"/>
2	256	<input type="checkbox"/>
3	256	<input type="checkbox"/>
4	256	<input type="checkbox"/>
5	256	<input type="checkbox"/>
6	256	<input type="checkbox"/>
7	256	<input type="checkbox"/>
8	256	<input type="checkbox"/>

Fig. 3-21

Parameter description:

IGMP snooping mode selection:

The switch supports to enable IGMP snooping function

Enable:

Set "Enable" mode to enable IGMP Snooping function.

Default: un-enable.

Unregistered Multicast Flooding :

The switch supports to enable Unregistered Multicast Flooding function

Enable:

Set "Enable" mode to enable IGMP Snooping function.

Default: Enable

General Query Interval :

The general query interval is the amount of time in seconds between IGMP General Query messages sent by the router (if the router is the querier on this subnet).

Available value: 1-2000 sec

General Query Max Response Time :

The Maximum Response Time field is only used in general or group-specific query messages. The Maximum Response Time is configured as the value for the Query response interval setting

Available value: 1-10 sec

General Query Timeout :

The General Query Timeout field is the amount of time in seconds.

Available value: 1-30 sec

Specific Query Count :

To set Specific Query Count on Switch .

Available value: 1-10 times

Specific Query Max Response Time :

To set the specific Query Response Time field is used in specific or group-specific query messages. The Specific Maximum Response Time is configured as the value.

Available value: 1-10 sec

Specific Query Timeout :

The Specific Query Timeout field is the amount of time in seconds.

Available value: 1-30 sec

3-9-2. IGMP VLAN

Function name:

IGMP VLAN

Function description:

Specify the a static connection to a multicast router for the VLAN.

IGMP VLAN

VID	<input type="text"/>	Add
Index	VID	
Delete		

Fig. 3-22

Parameter description:

VID:

To Set specify the IGMP snooping VLAN ID for each multicast group.

3-9-3. Group Allow

Function name:

Group Allowed

Function description:

The Group Allowed function allows the IGMP Snooping to set up the IP multicast table based on user's specific conditions. IGMP report packets that meet the items you set up will be joined or formed the multicast group.

Group Allow

VID 2	Start Address		End Address	
	<input type="text"/>		<input type="text"/>	
Port Member				
1. <input type="checkbox"/> 2. <input type="checkbox"/> 3. <input type="checkbox"/> 4. <input type="checkbox"/> 5. <input type="checkbox"/> 6. <input type="checkbox"/> 7. <input type="checkbox"/> 8. <input type="checkbox"/> 9. <input type="checkbox"/> 10. <input type="checkbox"/> 11. <input type="checkbox"/> 12. <input type="checkbox"/> 13. <input type="checkbox"/>				
14. <input type="checkbox"/> 15. <input type="checkbox"/> 16. <input type="checkbox"/> 17. <input type="checkbox"/> 18. <input type="checkbox"/> 19. <input type="checkbox"/> 20. <input type="checkbox"/> 21. <input type="checkbox"/> 22. <input type="checkbox"/> 23. <input type="checkbox"/> 24. <input type="checkbox"/> 25. <input type="checkbox"/> 26. <input type="checkbox"/>				
<input type="button" value="Add"/> <input type="button" value="Cancel"/> <input type="button" value="Edit"/>				

Index	Start Address	End Address	Port Member
1	224.0.0.1	224.0.0.254	5,6

Fig. 3-18

Parameter description:

IP Range:

The switch supports two kinds of options for managed valid IP range, including "Any" and "Custom". Default is "Any". In case that "Custom" had been chosen, you can assigned effective IP range. The valid range is 224.0.0.0~239.255.255.255.

VID:

The switch supports two kinds of options for managed valid VLAN VID, including "Any" and "Custom". Default is "Any". When you choose "Custom", you can fill in VID number. The valid VID range is 1~4094.

Port:

The switch supports two kinds of options for managed valid port range, including "Any" and "Custom". Default is "Any". You can select the ports that you would like them to be worked and restricted in the allowed group configuration if "Custom" had been chosen.

Add:

A new entry of allowed group configuration can be created after the parameters as mentioned above had been setup and then press **<Add>** button.

Edit:

The existed entry also can be modified after pressing **<Edit>** button.

Delete:

Remove the existed entry of allowed group configuration from the allowed group.

3-9-4. MVR Setting

Function name:

MVR Setting

Function description:

Multicast VLAN Registration (MVR) routes packets received in a multicast source VLAN to one or more receive VLANs. Clients are in the receive VLANs and the multicast server is in the source VLAN. Multicast routing has to be disabled when MVR is enabled. Refer to the configuration guide at Understanding Multicast VLAN Registration for more information on MVR..

MVR Setting

Multicast VLAN Registration		<input checked="" type="checkbox"/> Enable
Multicast VLAN ID		0

Port	Service Type	Tagging
1	None	<input type="checkbox"/>
2	None	<input type="checkbox"/>
3	Client	<input type="checkbox"/>
4	Router	<input type="checkbox"/>
5	None	<input type="checkbox"/>
6	None	<input type="checkbox"/>
7	None	<input type="checkbox"/>
8	None	<input type="checkbox"/>
9	None	<input type="checkbox"/>

Fig. 3-23

Parameter description:

Multicast VLAN Registration:

To Set the multicast VLAN registration function enable.

Multicast VLAN ID:

To Set the multicast VLAN ID.

Port No:

Display the port number. The number is 1 – 24.

Service Type:

To elect the service type which has three types include “None”, “ Client” and “ Router”

Tagging:

To elect port tag-out or not.

3-9-5. Multicast Status

Function name:

Multicast Status

Function description:

The Multicast Status function allows to display the switch received multicast traffic status. If the switch doesn't receive any multicast traffic then it will display the "No multicast entry !"

A yellow rectangular box with a black border containing the text "No multicast entry!".

Fig. 3-24

Parameter description:

No:

To display current built-up multicast group entry index.

Group Address :

To display current built-up multicast Group Address

VID:

To display current built-up multicast VLAN ID .

Port Members:

To display current built-up multicast port members .

Previous Page:

To display previous page context.

Next Page:

To display next page context.

Refresh:

To Update multicast group membership.

3-9-6. RADIUS IGMP

Function name:

RADIUS IGMP

Function description:

The RADIUS IGMP function allows to some multicast applications, such as IPTV and Internet Radio, may be of minimal interest to law enforcement agencies, other multicast traffic may contain information important to an investigation. The problem of not intercepting incoming multicast traffic affects not only targets directly intercepted by IP address, but also targets intercepted by login name, calling line identity, MAC address, and similar identities used by such protocols as RADIUS and DHCP for authentication and dynamic IP allocation.

A lawful interception solution that analyzes RADIUS and DHCP for target IP addresses will likely fail to intercept incoming multicast traffic to the target.

Radius Server 1	192.168.1.1
Port Number(1~65535)	1812
Radius Server 2	192.168.1.1
Port Number(1~65535)	1812
Secret Key	Radius
Accounting Server 1	192.168.1.1
Port Number(1~65535)	1813
Accounting Server 2	192.168.1.1
Port Number(1~65535)	1813
Secret Key	Radius
Response Timeout	2
Number of Retry	1

Port Member	<input type="checkbox"/> 01 <input type="checkbox"/> 02 <input type="checkbox"/> 03 <input type="checkbox"/> 04 <input type="checkbox"/> 05 <input type="checkbox"/> 06 <input type="checkbox"/> 07 <input type="checkbox"/> 08 <input type="checkbox"/> 09 <input type="checkbox"/> 10 <input type="checkbox"/> 11 <input type="checkbox"/> 12 <input type="checkbox"/> 13
	<input type="checkbox"/> 14 <input type="checkbox"/> 15 <input type="checkbox"/> 16 <input type="checkbox"/> 17 <input type="checkbox"/> 18 <input type="checkbox"/> 19 <input type="checkbox"/> 20 <input type="checkbox"/> 21 <input type="checkbox"/> 22 <input type="checkbox"/> 23 <input type="checkbox"/> 24 <input type="checkbox"/> 25 <input type="checkbox"/> 26
	<input type="checkbox"/> Select/Unselect All

Fig. 3-24

Parameter description:

Radius Server 1 and 2:

RADIUS server 1 and 2 IP address for authentication.

Default: 192.168.1.1

Port Number:

The port number to communicate with RADIUS server for the authentication service. The valid value ranges 1-65535.

Default port number is 1812.

Secret Key:

The secret key between authentication server and authenticator. It is a string with the length 1 – 31 characters. The character string may contain upper case, lower case and 0-9. It is character sense. It is not allowed for putting a blank between any two characters.

Default: Radius

To display current built-up multicast VLAN ID .

Response Timeout:

A timeout condition in the exchange between the authenticator and the authentication server. The valid range: 1 –65535.

Default: 2 seconds

Number of Retry (1-10):

The maximum of number times that the authenticator will retransmit an EAP Request to the supplicant before it times out the authentication session. The valid range: 1 – 10.

Default: 1 time

Port Members:

To set the RADIUS IGMP multicast port members .

3-10. LLDP

The switch supports the LLDP. For current information on your switch model, The Link Layer Discovery Protocol (LLDP) provides a standards-based method for enabling switches to advertise themselves to adjacent devices and to learn about adjacent LLDP devices.

3-10-1 . LLDP State

Function name:

LLDP State

Function description:

The LLDP state function, you can set per port the LLDP configuration and the detail parameters, the settings will take effect immediately.

LLDP Configuration

Tx Interval	30	(5 - 32768 seconds)
Tx Hold	4	(2 - 10 times)
Tx Delay	2	(1 - 8196 seconds)
Tx Reinit	2	(1 - 10 seconds)
Notification Interval	5	(5 - 3600 seconds)

Port	Mode	Optional TLVs					Notification
		Port Descr	Sys Name	Sys Descr	Sys Capa	Mgmt Addr	
1	Disabled	<input checked="" type="checkbox"/>	<input checked="" type="checkbox"/>	<input checked="" type="checkbox"/>	<input checked="" type="checkbox"/>	<input checked="" type="checkbox"/>	<input type="checkbox"/>
2	Disabled	<input checked="" type="checkbox"/>	<input checked="" type="checkbox"/>	<input checked="" type="checkbox"/>	<input checked="" type="checkbox"/>	<input checked="" type="checkbox"/>	<input type="checkbox"/>
3	Disabled	<input checked="" type="checkbox"/>	<input checked="" type="checkbox"/>	<input checked="" type="checkbox"/>	<input checked="" type="checkbox"/>	<input checked="" type="checkbox"/>	<input type="checkbox"/>
4	Disabled	<input checked="" type="checkbox"/>	<input checked="" type="checkbox"/>	<input checked="" type="checkbox"/>	<input checked="" type="checkbox"/>	<input checked="" type="checkbox"/>	<input type="checkbox"/>
5	Disabled	<input checked="" type="checkbox"/>	<input checked="" type="checkbox"/>	<input checked="" type="checkbox"/>	<input checked="" type="checkbox"/>	<input checked="" type="checkbox"/>	<input type="checkbox"/>
6	Disabled	<input checked="" type="checkbox"/>	<input checked="" type="checkbox"/>	<input checked="" type="checkbox"/>	<input checked="" type="checkbox"/>	<input checked="" type="checkbox"/>	<input type="checkbox"/>
7	Disabled	<input checked="" type="checkbox"/>	<input checked="" type="checkbox"/>	<input checked="" type="checkbox"/>	<input checked="" type="checkbox"/>	<input checked="" type="checkbox"/>	<input type="checkbox"/>
8	Disabled	<input checked="" type="checkbox"/>	<input checked="" type="checkbox"/>	<input checked="" type="checkbox"/>	<input checked="" type="checkbox"/>	<input checked="" type="checkbox"/>	<input type="checkbox"/>

Fig. 3-18-1 LLDP parameter

Parameter description:

- Tx Interval** : To changes the interval between consecutive transmissions of LLDP advertisements on any given port. **(Default: 30 secs)**
- Tx Hold** : The specifies the amount of time the receiving device holds a Link Layer Discovery Protocol (LLDP) packet before discarding it. **(Default: 4 times)**
- Tx Delay** : The specifies the delay between successive LLDP frame transmissions initiated by value/status changes in the LLDP local systems MIB. **(Default: 2 secs)**
- Tx Reinit** : The specifies the minimum time an LLDP port waits before

reinitializing LLDP transmission. **(Default: 2 secs)**

Notification

Interval: The minimum interval for LLDP data change Notification for the same neighbor. Refer to IEEE 802.1AB-2005 or later for more information. **(Default: 5 secs)**

Mode : To enable or disable the LLDP mode per port. There are four types: Disable, Tx_Rx, Tx only and Rx only

Port Descr : To evoke the outbound LLDP advertisements, includes an alphanumeric string describing the port.

Sys Name : To evoke the outbound LLDP advertisements, includes the system's assigned name

Sys Descr : To evoke outbound LLDP advertisements, includes an alphanumeric string describing the full name and version identification for the system's hardware type, software version, and networking application.

Sys Capa : To evoke outbound advertisements, includes a bitmask of system capabilities (device functions) that are supported. Also includes information on whether the capabilities are enabled.

Mgmt Addr : To evoke outbound advertisements, includes information on management address. you can use to include a specific IP address in the outbound LLDP advertisements for specific ports

Notification : Default: Disabled.

Enables or disables each port for sending notification to configured SNMP trap receiver if an LLDP data change is detected in an advertisement received on the port from LLDP neighbor.

3-10-2 . LLDP Entry

Function name:

LLDP Entry

Function description:

The LLDP Entry function allows a switch to display per port which build the LLDP available entry. This information can be useful in tracking LLDP packets back to a physical port.

LLDP Neighbor Information

Refresh Interval ▼

Local Port	Chassis ID	Remote Port ID	System Name	Port Description	System Capabilities	Management Address
There is no entry for LLDP remote table						

Fig. 3-18-2 LLDP Entry

Parameter description:

Local port:

To display the switch local port.

Chassis ID:

To display the Chassis ID which connect to the switch and what the neighbor Chassis ID.

Remote Port ID:

To display the Remote Port ID which connect to the switch and what the neighbor's remote port ID.

System name:

To display the system name which connect to the switch and which device supports the LLDP

Port Description:

To display an alphanumeric string describing the port what the neighbor's port description.

System Capabilities:

To display an includes a bitmask of system capabilities (device functions)

that are supported. Also includes information on whether the capabilities are enabled.

Management Address:

To display include a specific IP address in the outbound LLDP advertisements for specific ports.

Auto - refresh:

Refresh the authenticator counters in the web UI automatically

Refresh:

Click on the <Refresh> to update the authenticator counters in the web UI

3-10-3 . LLDP Statistics

Function name:

LLDP Counter

Function description:

Display the detailed counting number of each port's LLDP traffic.

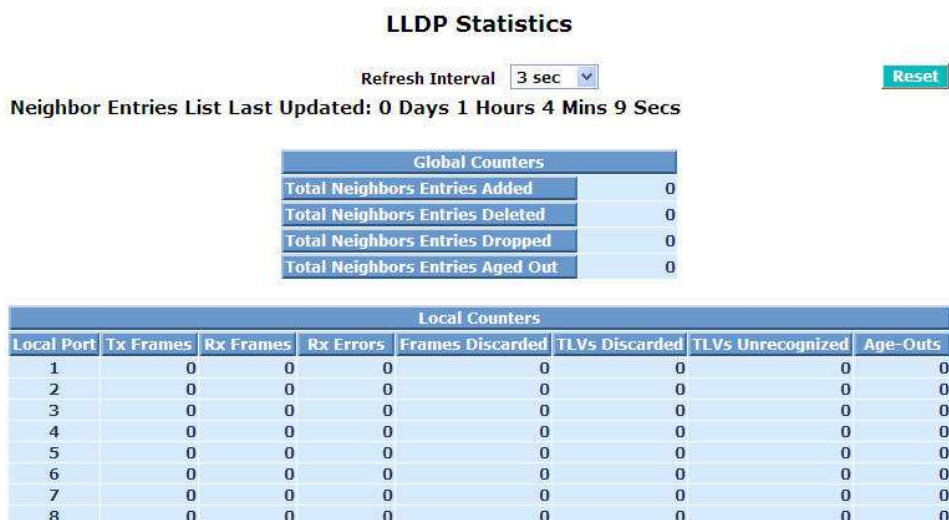

Fig. 3-18-3 LLDP statistics

Parameter description:

Neighbor Entries List Last Updated :

The time period which neighbor entries List were be updated .

Total Neighbors Entries Added:

The total neighbors entries added be received.

Total Neighbors Entries Deleted:

The total neighbors entries deleted be received.

Total Neighbors Entries Dropped:

The total neighbors entries dropped be received.

Total Neighbors Entries Aged Out:

The total neighbors entries aged out be received.

Local port:

Show the local port on the switch.

Tx Frames:

The counting number of the frames transmitted.

Rx Frames:

The counting number of the frames transmitted.

Frames Discarded:

Show the number of frame discarded.

TLVs Discarded:

Show the number of TLVs discarded.

TLVs Unrecognized:

Show the number of TLVs unrecognized.

Age Outs:

Show the number of Age Outs.

3-11. VLAN

The switch supports Tag-based VLAN (802.1q) and Port-based VLAN. Support 256 active VLANs and VLAN ID 1~4094. VLAN configuration is used to partition your LAN into small ones as your demand. Properly configuring it, you can gain not only improving security and increasing performance but greatly reducing VLAN management.

3-11-1. VLAN Mode

Function name:

VLAN Mode Setting

Function description:

The VLAN Mode Selection function includes two modes: Port-based and Tag-based, you can choose one of them by pulling down list and pressing the **<Downward>** arrow key. Then, click **<Apply>** button, the settings will take effect immediately.

VLAN Mode

VLAN Mode	Tag-based
Symmetric Vlan	Disable
SVL	Disable
Double Tag	Disable
Up-Link Port	26 Port

Apply

Fig. 3-25

Parameter description:

VLAN Mode:

Tag-based:

This is the default setting.

Tag-based VLAN identifies its member by VID. This is quite different from port-based VLAN. If there are any more rules in ingress filtering list or egress filtering list, the packet will be screened with more filtering criteria to determine if it can be forwarded. The switch supports supplement of 802.1q..

Each tag-based VLAN you built up must be assigned VLAN name and VLAN ID. Valid VLAN ID is 1-4094. User can create total up to 256 Tag VLAN groups.

Port-based:

Port-based VLAN is defined by port. Any packet coming in or outgoing from any one port of a port-based VLAN will be accepted. No filtering criterion applies in port-based VLAN. The only criterion is the physical port you connect to. For example, for a port-based VLAN named PVLAN-1 contains port members Port 1&2&3&4. If you are on the port 1, you can communicate with port 2&3&4. If you are on the port 5, then you cannot talk to them. Each port-based VLAN you built up must be assigned a group name. This switch can support up to maximal 26 port-based VLAN groups.

Metro Mode:

The Metro Mode is a quick configuration VLAN environment method on Port-based VLAN. It will create 22 or 23 Port-based VLAN groups.

Symmetric Vlan:

This is a Ingress Rule (Rule 1, The Ingress Filtering Rule 1 is “forward only packets with VID matching this port’s configured VID”). For example, if port 1 receives a tagged packet with VID=100 (VLAN name=VLAN100), and if Symmetric-Vlan function is enabled, the switch will check if port 1 is a member of VLAN100. If yes, the received packet is forwarded; otherwise, the received packet is dropped.

Note: If Symmetric is enabled and port 1, for example, receives an untagged packet, the switch will apply the PVID of port 1 to tag this packet, the packet then will be forwarded. But if the PVID of port 1 is not 100, the packet will be dropped.

SVL:

While SVL is enable, all VLANs use the same filtering database storing the membership information of the VLAN to learn or look up the membership information of the VLAN. While SVL is disable, it means learning mode is IVL. In this mode, different VLAN uses different filtering database storing the membership information of the VLAN to learn or look up the information of a VLAN member.

Double Tag:

Double-tag mode belongs to the tag-based mode, however, it would treat all frames as the untagged ones, which means that tag with PVID will be added into all packets. Then, these packets will be forwarded as Tag-based VLAN. So, the incoming packets with tag will become the double-tag ones.

Up-link Port:

This function is enabled only when metro mode is chosen in VLAN mode.

25:

Except Port 25, each port of the switch cannot transmit packets with each other. Each port groups a VLAN with Port 25, thus, total 23 groups consisting of 2 members are formed.

26:

Except Port 26, each port of the switch cannot transmit packets with each other. Each port groups a VLAN with Port 26, thus, total 23 groups consisting of 2 members are formed.

25&26:

Except Port 25 and Port 26, each port of the switch cannot transmit packets with each other. Each port groups a VLAN with Port 25 and Port 26, thus, total 22 groups consisting of 3 members are formed.

3-11-2. Tag-based Group

Function name:

Tag-based Group Configuration

Function description:

It shows the information of existed Tag-based VLAN Groups. You can also easily create, edit and delete a Tag-based VLAN group by pressing **<Add>**, **<Edit>** and **<Delete>** function buttons. User can add a new VLAN group by inputting a new VLAN name and VLAN ID after pressing **<Add>** button.

Tag-based Group

No	VLAN NAME	VID	Action
1	default	1	Active
2	mvr_reserved	3	Active



Fig. 3-26

Parameter description:

No:

To display current built-up tag base VLAN entry index

VLAN Name:

The name defined by administrator is associated with a VLAN group. Valid letters are A-Z, a-z, 0-9, “ - “ and “_” characters. The maximal length is 15 characters.

VID:

VLAN identifier. Each tag-based VLAN group has a unique VID. It appears only in tag-based and Double-tag mode.

GVRP Propagation:

This is used to enable or disable if a port is a member of the new added VLAN, “Enable” means it is a member of the VLAN. You can configure an individual port to actively or passively participate in dynamic VLAN propagation or to ignore dynamic VLAN (GVRP) operation.

Member:

This is used to enable or disable if a port is a member of the new added VLAN, "Enable" means it is a member of the VLAN. Just tick the check box beside the port x to enable it.

Utag:

This is used to enable or disable if a port is a utag member of the new added VLAN, "Enable" means it is a utag member of the VLAN. Just tick the check box beside the port x to enable it.

Action:

The mode here means the type of participant. There are two modes, Active and NotInService, provided for the user's choice.

Active:

It is Active Participant. In this mode, the switch participates active in GARP protocol exchanges. The default setting is Active.

NotInService:

It is NotInService. In this mode, the switch does not send or reply any GARP messages. It just listens messages and reacts for the received GVRP BPDUs.

Tag-based VLAN

VLAN name	<input type="text"/>							
VID	<input type="text"/>							
GVRP Propagation	Disable ▾							
Member	1. <input type="checkbox"/>	2. <input type="checkbox"/>	3. <input type="checkbox"/>	4. <input type="checkbox"/>	5. <input type="checkbox"/>	6. <input type="checkbox"/>	7. <input type="checkbox"/>	8. <input type="checkbox"/>
	9. <input type="checkbox"/>	10. <input type="checkbox"/>	11. <input type="checkbox"/>	12. <input type="checkbox"/>	13. <input type="checkbox"/>	14. <input type="checkbox"/>	15. <input type="checkbox"/>	16. <input type="checkbox"/>
	17. <input type="checkbox"/>	18. <input type="checkbox"/>	19. <input type="checkbox"/>	20. <input type="checkbox"/>	21. <input type="checkbox"/>	22. <input type="checkbox"/>	23. <input type="checkbox"/>	24. <input type="checkbox"/>
	25. <input type="checkbox"/>	26. <input type="checkbox"/>						
Untag	1. <input type="checkbox"/>	2. <input type="checkbox"/>	3. <input type="checkbox"/>	4. <input type="checkbox"/>	5. <input type="checkbox"/>	6. <input type="checkbox"/>	7. <input type="checkbox"/>	8. <input type="checkbox"/>
	9. <input type="checkbox"/>	10. <input type="checkbox"/>	11. <input type="checkbox"/>	12. <input type="checkbox"/>	13. <input type="checkbox"/>	14. <input type="checkbox"/>	15. <input type="checkbox"/>	16. <input type="checkbox"/>
	17. <input type="checkbox"/>	18. <input type="checkbox"/>	19. <input type="checkbox"/>	20. <input type="checkbox"/>	21. <input type="checkbox"/>	22. <input type="checkbox"/>	23. <input type="checkbox"/>	24. <input type="checkbox"/>
	25. <input type="checkbox"/>	26. <input type="checkbox"/>						
Action	Active ▾							

Fig. 3-27

Delete Group:

Just press the **<Delete>** button to remove the selected group entry from the Tag-based group table.

Edit a group:

Just select a group entry and press the **<Edit>** button, then you can modify a group's description, member and untag settings.

3-11-3. PVID

Function name:

PVID

Function description:

In PVID Setting, user can input VID number to each port. The range of VID number is from 1 to 4094. User also can choose ingress filtering rule (Rule 2) to each port. The Ingress Filtering Rule 2 is “drop untagged frame”. While Rule 2 is enabled, the port will discard all Untagged-frames.

PVID

Port No	PVID	Default Priority	Drop Untag
1	1	0	Disable
2	1	0	Disable Enable
3	1	0	Disable
4	1	0	Disable
5	1	0	Disable
6	1	0	Disable
7	1	0	Disable
8	1	0	Disable

Fig. 3-29

Parameter description:

Port 1-26:

Port number.

PVID:

This PVID range will be 1-4094. Before you set a number x as PVID, you have to create a Tag-based VLAN with VID x. For example, if port x receives an untagged packet, the switch will apply the PVID (assume as VID y) of port x to tag this packet, the packet then will be forwarded as the tagged packet with VID y.

Default Priority:

It bases on 802.1p QoS and affects untagged packets. When the packets enter the switch, it would get the priority precedence according to your Default Priority setting and map to 802.1p priority setting in QoS function. For example, while you set Default Priority of port 2 with 2 and transmit untagged packets to port 2, these packets will own priority 2 precedence due to your default 802.1p Priority Mapping setting in QoS function and be put into Queue 1.

Drop Untag:

Drop untagged frame. You can configure a given port to accept all frames (Tagged and Untagged) or just receive tagged frame. If the former is the case, then the packets with tagged or untagged will be processed. If the later is the case, only the packets carrying VLAN tag will be processed, the rest packets will be discarded.

3-11-4. Port-based Group

Function name:

Port-based Group Configuration

Function description:

It shows the information of the existed Port-based VLAN Groups. You can easily create, edit and delete a Port-based VLAN group by pressing **<Add>**, **<Edit>** and **<Delete>** function buttons. User can add a new VLAN group by inputting a new VLAN name.

Port-based Group

No	VLAN NAME
1	default



Fig. 3-30

Parameter description:

VLAN Name:

The name defined by administrator is associated with a VLAN group. Valid letters are A-Z, a-z, 0-9, “ - ” and “_” characters. The maximal length is 15 characters.

Member:

This is used to enable or disable if a port is a member of the new added VLAN, “Enable” means it is a member of the VLAN. Just tick the check box beside the port x to enable it.

Add Group:

Create a new Port-based VLAN. Input the VLAN name and choose the member by ticking the check box beside the port No., then, press the **<Apply>** button to have the setting taken effect.

Port-based VLAN

VLAN name								
Member	1. <input type="checkbox"/>	2. <input type="checkbox"/>	3. <input type="checkbox"/>	4. <input type="checkbox"/>	5. <input type="checkbox"/>	6. <input type="checkbox"/>	7. <input type="checkbox"/>	8. <input type="checkbox"/>
	9. <input type="checkbox"/>	10. <input type="checkbox"/>	11. <input type="checkbox"/>	12. <input type="checkbox"/>	13. <input type="checkbox"/>	14. <input type="checkbox"/>	15. <input type="checkbox"/>	16. <input type="checkbox"/>
	17. <input type="checkbox"/>	18. <input type="checkbox"/>	19. <input type="checkbox"/>	20. <input type="checkbox"/>	21. <input type="checkbox"/>	22. <input type="checkbox"/>	23. <input type="checkbox"/>	24. <input type="checkbox"/>
	25. <input type="checkbox"/>	26. <input type="checkbox"/>						

Apply

Fig. 3-31

Delete Group:

Just press the **<Delete>** button to remove the selected group entry from the Port-based group table.

Port-based Group

No	VLAN NAME
1	default
2	3

Add **Edit** **Delete**

Fig. 3-32

Edit a group:

Just select a group entry and press the **<Edit>** button, then you can modify a group's description and member set.

3-11-5. Management VLAN

Function name:

Management VLAN

Function Description:

To assign a specific VLAN for management purpose.

Management VLAN

State	Disable ▾
VID	1

Fig. 3-33

Parameter description:

State:

It works when the tag-based mode is chosen. When this function is enabled, only the tagged packets with this VID can manage the switch.

VID:

Valid range 1~4094.

3-12. MAC Table

MAC Table Configuration gathers many functions, including MAC Table Information, MAC Table Maintenance, Static and MAC Alias, which cannot be categorized to some function type. They are described below.

Function name:

MAC Table Information

Function Description:

Display the static or dynamic learning MAC entry and the state for the selected port.

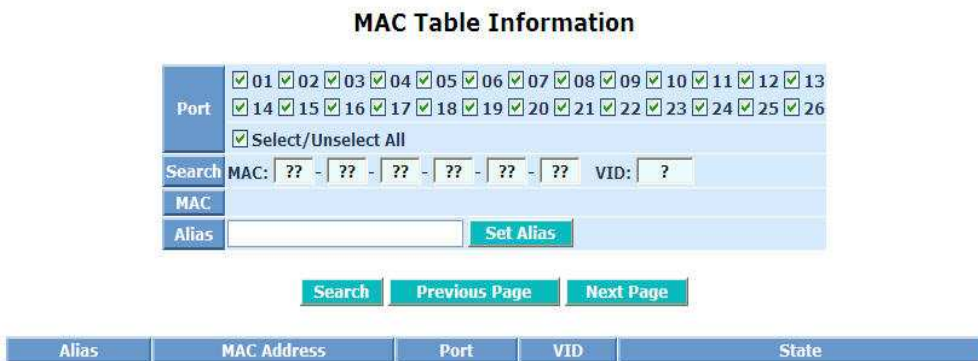

Fig. 3-34

Parameter description:

Port:

Select the port you would like to inquire.

Search:

Set up the MAC entry you would like to inquire.

The default is ??-??-??-??-??-??

MAC:

Display the MAC address of one entry you selected from the searched MAC entries table.

Alias:

Set up the Alias for the selected MAC entry.

Set Alias:

Save the Alias of MAC entry you set up.

Search:

Find the entry that meets your setup.

Previous Page:

Move to the previous page.

Next Page:

Move to the next page.

Alias:

The Alias of the searched entry.

MAC Address:

The MAC address of the searched entry.

Port:

The port that exists in the searched MAC Entry.

VID:

VLAN Group that MAC Entry exists.

State:

Display the method that this MAC Entry is built. It may show "Dynamic MAC" or "Static MAC".

Function Name:

MAC Table Maintenance

Function Description:

This function can allow the user to set up the processing mechanism of MAC Table. An idle MAC address exceeding MAC Address Age-out Time will be removed from the MAC Table. The range of Age-out Time is 10-1000000 seconds, and the setup of this time will have no effect on static MAC addresses.

In addition, the learning limit of MAC maintenance is able to limit the amount of MAC that each port can learn.

MAC Maintenance

Aging time			
Enable <input type="checkbox"/>	<input type="text" value="300"/>	Secs (10~1000000)	<input type="button" value="Apply"/>
Flush MAC Table			<input type="button" value="Flush"/>
Learning Limit (0~8191)			
Port No	Limit	Port No	Limit
1	<input type="text" value="8191"/>	2	<input type="text" value="8191"/>
3	<input type="text" value="8191"/>	4	<input type="text" value="8191"/>
5	<input type="text" value="8191"/>	6	<input type="text" value="8191"/>
7	<input type="text" value="8191"/>	8	<input type="text" value="8191"/>
9	<input type="text" value="8191"/>	10	<input type="text" value="8191"/>
11	<input type="text" value="8191"/>	12	<input type="text" value="8191"/>
13	<input type="text" value="8191"/>	14	<input type="text" value="8191"/>
15	<input type="text" value="8191"/>	16	<input type="text" value="8191"/>

Fig. 3-35

Parameter description:

Aging Time:

Delete a MAC address idling for a period of time from the MAC Table, which will not affect static MAC address. Range of MAC Address Aging Time is 10-1000000 seconds. The default Aging Time is 300 seconds.

Learning Limit:

To set up the maximum amount of MAC that each port can learn. Valid value of learning limit for port 1~24 ranges from 0-8191. As to port 25~port 26, only the fixed value "8192" is assigned to these two ports and user cannot configure this value.

Function Name:

Static Setting

Function Description:

The function of Static is used to configure MAC's real manners inside of the switch. Three kinds of manners including static, static with destination drop and static with source drop are contained in this function .

As "static" is chosen, assign a MAC address to a specific port, all of the switch's traffics sent to this MAC address will be forwarded to this port.

As "static with destination drop" is chosen, the packet will be dropped if its DA is equal to the value you set up. Due to this setting belongs to the global one, so, it may affect all ports' transmission of the packets.

As "static with source drop" is chosen, the packet will be dropped if its SA is equal to the value you set up. Due to this setting belongs to the global one, so, it may affect all ports' transmission of the packets.

Static MAC

MAC						VID	Forwarding Rule	Port
00	34	1q	24	5r	33	2	Static with Destination Drop	2

No	MAC	VID	Forwarding Rule	Port
1	00-32-00-33-5D-32	2	Static	15

Fig. 3-36

Parameter description:

MAC:

It is a six-byte long Ethernet hardware address and usually expressed by hex and separated by hyphens. For example,

00 – 40 - C7 - D6 – 00 - 01

VID:

VLAN identifier. This will be filled only when tagged VLAN is applied. Valid range is 1 ~ 4094.

Forwarding Rule(Drop Policy):

Static:

A MAC address is assigned to a specific port, all of the switch's traffics sent to this MAC address will be forwarded to this port.

Static with Destination Drop:

While the DA of the incoming packets meets the value you set up, these packets will be dropped.

Static with Source Drop:

While the SA of the incoming packets meets the value you set up, these packets will be dropped.

Port :

Select the port No. you would like to do setup in the switch. It is 1 ~26.

Function name:

MAC Alias

Function description:

MAC Alias function is used to let you assign MAC address a plain English name. This will help you tell which MAC address belongs to which user in the illegal access report. At the initial time, it shows all pairs of the existed alias name and MAC address.

There are three MAC alias functions in this function folder, including MAC Alias Add, MAC Alias Edit and MAC Alias Delete. You can click **<Create/Edit>** button to add/modify a new or an existed alias name for a specified MAC address, or mark an existed entry to delete it. Alias name must be composed of A-Z, a-z and 0-9 only and has a maximal length of 15 characters.



Fig. 3-37

Parameter description:

MAC Address:

It is a six-byte long Ethernet hardware address and usually expressed by hex and separated by hyphens. For example,

00 - 40 - C7 - D6 - 00 - 02

Alias:

MAC alias name you assign.

Note: If there are too many MAC addresses learned in the table, we recommend you inputting the MAC address and alias name directly.

Function name:

Port Security

Function description:

Port Security function is used to let you assign the port authenticate with the MAC address for security purpose.

Port Security

1. <input type="checkbox"/>	2. <input type="checkbox"/>	3. <input type="checkbox"/>	4. <input type="checkbox"/>	5. <input type="checkbox"/>	6. <input type="checkbox"/>	7. <input type="checkbox"/>	8. <input type="checkbox"/>
9. <input type="checkbox"/>	10. <input type="checkbox"/>	11. <input type="checkbox"/>	12. <input type="checkbox"/>	13. <input type="checkbox"/>	14. <input type="checkbox"/>	15. <input type="checkbox"/>	16. <input type="checkbox"/>
17. <input type="checkbox"/>	18. <input type="checkbox"/>	19. <input type="checkbox"/>	20. <input type="checkbox"/>	21. <input type="checkbox"/>	22. <input type="checkbox"/>	23. <input type="checkbox"/>	24. <input type="checkbox"/>
25. <input type="checkbox"/>	26. <input type="checkbox"/>						

Fig. 3-37-1

Parameter description:

Port:

Select the port you would like to inquire.

Function name:

Port static MAC

Function description:

Port Static MAC function is used to let you assign per port authenticate with the static MAC address for security purpose.

Port Static MAC Port 4 ▾

No	MAC	VID
1	00-32-2E-35-00-22	2

Add Edit Delete

Port 4 Static Mac

MAC	<input type="text"/>	<input type="text"/>	<input type="text"/>	<input type="text"/>	<input type="text"/>	<input type="text"/>
VID	<input type="text"/>					

Apply

Fig. 3-37-1

Parameter description:

MAC Address:

It is a six-byte long Ethernet hardware address and usually expressed by hex and separated by hyphens. For example,

00 – 40 - C7 - D6 – 00 - 02

VID:

VLAN Group ID that MAC Entry for the port member exists.

3-13. GVRP Configuration

GVRP is an application based on Generic Attribute Registration Protocol (GARP), mainly used to automatically and dynamically maintain the group membership information of the VLANs. The GVRP offers the function providing the VLAN registration service through a GARP application. It makes use of GARP Information Declaration (GID) to maintain the ports associated with their attribute database and GARP Information Propagation (GIP) to communicate among switches and end stations. With GID information and GIP, GVRP state machine maintain the contents of Dynamic VLAN Registration Entries for each VLAN and propagate these information to other GVRP-aware devices to setup and update their knowledge database, the set of VLANs associated with currently active members, and through which ports these members can be reached.

In GVRP Configuration function folder, there are three functions supported, including GVRP Config, GVRP Counter and GVRP Group explained below.

GVRP Configuration

GVRP State: Enabled Apply

Port	Join Time	Leave Time	LeaveAll Time	Default Applicant Mode	Default Registrar Mode	Restricted Mode
1	20	60	1000	Normal	Normal	Disabled
2	20	60	1000	Normal	Normal	Disabled
3	20	60	1000	Normal	Normal	Disabled
4	20	60	1000	Normal	Normal	Disabled

Fig. 3-38

Function name:

GVRP Config

Function description:

In the function of GVRP Config, it is used to configure each port's GVRP operation mode, in which there are seven parameters needed to be configured described below.

Parameter description:

GVRP State Setting:

This function is simply to let you enable or disable GVRP function. You can pull down the list and click the **<Downward>** arrow key to choose "Enable" or "Disable". Then, click the **<Apply>** button, the system will take effect immediately.

Join Time:

Used to declare the Join Time in unit of centisecond. Valid time range: 20 –100 centisecond, Default: 20 centisecond.

Leave Time:

Used to declare the Leave Time in unit of centisecond. Valid time range: 60 –300 centisecond, Default: 60 centisecond.

Leave All Time:

A time period for announcement that all registered device is going to be de-registered. If someone still issues a new join, then a registration will be kept in the switch. Valid range: 1000-5000 unit time, Default: 1000 unit time.

Default Applicant Mode:

The mode here means the type of participant. There are two modes, normal participant and non-participant, provided for the user's choice.

Normal:

It is Normal Participant. In this mode, the switch participates normally in GARP protocol exchanges. The default setting is Normal.

Non-Participant:

It is Non-Participant. In this mode, the switch does not send or reply any GARP messages. It just listens messages and reacts for the received GVRP BPDU.

Default Registrar Mode:

The mode here means the type of Registrar. There are three types of parameters for registrar administrative control value, normal registrar, fixed registrar and forbidden registrar, provided for the user's choice.

Normal:

It is Normal Registration. The Registrar responds normally to incoming GARP messages. The default setting is Normal.

Fixed:

It is Registration Fixed. The Registrar ignores all GARP messages, and all members remain in the registered (IN) state.

Forbidden:

It is Registration Forbidden. The Registrar ignores all GARP messages, and all members remain in the unregistered (EMPTY) state.

Restricted Mode:

This function is used to restrict dynamic VLAN be created when this port received GVRP PDU. There are two modes, disable and enable, provided for the user's choice.

Disabled:

In this mode, the switch dynamic VLAN will be created when this port received GVRP PDU. The default setting is Normal.

Enabled:

In this mode, the switch does not create dynamic VLAN when this port received GVRP PDU. Except received dynamic VLAN message of the GVRP PDU is an existed static VLAN in the switch, this port will be added into the static VLAN members dynamically.

Function name:

GVRP Counter

Function description:

All GVRP counters are mainly divided into Received and Transmitted two categories to let you monitor the GVRP actions. Actually, they are GARP packets.

Counter Name	Received	Transmitted
Total GVRP Packets	0	0
Invalid GVRP Packets	0	----
LeaveAll message	0	0
JoinEmpty message	0	0
JoinIn message	0	0
LeaveEmpty message	0	0
Empty message	0	0

Refresh

Fig. 3-39

Parameter description:

Received:

Total GVRP Packets:

Total GVRP BPDU is received by the GVRP application.

Invalid GVRP Packets:

Number of invalid GARP BPDU is received by the GARP application.

LeaveAll Message Packets:

Number of GARP BPDU with Leave All message is received by the GARP application.

JoinEmpty Message Packets:

Number of GARP BPDU with Join Empty message is received by the GARP application.

JoinIn Message Packets:

Number of GARP BPDU with Join In message is received by the GARP application.

LeaveEmpty Message Packets:

Number of GARP BPDU with Leave Empty message is received by the GARP application.

Empty Message Packets:

Number of GARP BPDU with Empty message is received by the GARP application.

Transmitted:

Total GVRP Packets:

Total GARP BPDU is transmitted by the GVRP application.

Invalid GVRP Packets:

Number of invalid GARP BPDU is transmitted by the GVRP application.

LeaveAll Message Packets:

Number of GARP BPDU with Leave All message is transmitted by the GARP application.

JoinEmpty Message Packets:

Number of GARP BPDU with Join Empty message is transmitted by the GARP application.

JoinIn Message Packets:

Number of GARP BPDU with Join In message is transmitted by the GARP application.

LeaveEmpty Message Packets:

Number of GARP BPDU with Leave Empty message is transmitted by the GARP application.

Empty Message Packets:

Number of GARP BPDU with Empty message is transmitted by the GARP application.

Function name:

GVRP Group Information

Function description:

To show the dynamic group member and their information.

GVRP VLAN Group Information

Current Dynamic Group Number	0
VID	Member Port
Edit Administrative Control	Refresh

Fig. 3-40

Parameter description:

Current Dynamic Group Number:

The number of GVRP group that are created currently.

VID:

VLAN identifier. When GVRP group creates, each dynamic VLAN group owns its VID. Valid range is 1 ~ 4094.

Member Port:

Those are the members belonging to the same dynamic VLAN group.

Edit Administrative Control:

When you create GVRP group, you can use Administrative Control function to change Applicant Mode and Registrar Mode of GVRP group member.

Refresh:

Refresh function can help you to see current GVRP group status.

3-14. STP Configuration

The Spanning Tree Protocol (STP) is a standardized method (IEEE 802.1D) for avoiding loops in switched networks. When STP is enabled, ensure that only one path is active between any two nodes on the network at a time. User can enable Spanning Tree Protocol on switch's web management and then set up other advanced items. We recommend that you enable STP on all switches to ensure a single active path on the network.

3-14-1. STP Status

Function name:

STP Status

Function description:

In the Spanning Tree Status, user can read 12 parameters to know STP current status. The 12 parameters' description is listed in the following table.

STP Status

STP State	Disabled
Bridge ID	00:40:C7:F8:00:E5
Bridge Priority	32768
Designated Root	00:40:C7:F8:00:E5
Designated Priority	32768
Root Port	0
Root Path Cost	0
Current Max. Age(sec)	20
Current Forward Delay(sec)	15
Hello Time(sec)	2
STP Topology Change Count	0
Time Since Last Topology Change(sec)	0

Fig. 3-41

Parameter description:

STP State:

Show the current STP Enabled / Disabled status. Default is "Disabled".

Bridge ID:

Show switch's bridge ID which stands for the MAC address of this switch.

Bridge Priority:

Show this switch's current bridge priority setting. Default is 32768.

Designated Root:

Show root bridge ID of this network segment. If this switch is a root

bridge, the “Designated Root” will show this switch’s bridge ID.

Designated Priority:

Show the current root bridge priority.

Root Port:

Show port number connected to root bridge with the lowest path cost.

Root Path Cost:

Show the path cost between the root port and the designated port of the root bridge.

Current Max. Age:

Show the current root bridge maximum age time. Maximum age time is used to monitor if STP topology needs to change. When a bridge does not receive a hello message from root bridge until the maximum age time is counted down to 0, the bridge will treat the root bridge malfunctioned and issue a Topology Change Notification (TCN) BPDU to all other bridges.

All bridges in the LAN will re-learn and determine which the root bridge is. Maximum Age time is assigned by root bridge in unit of seconds. Default is 20 seconds.

Current Forward Delay:

Show the current root bridge forward delay time. The value of Forward Delay time is set by root. The Forward Delay time is defined as the time spent from Listening state moved to Learning state or from Learning state moved to Forwarding state of a port in bridge.

Hello Time:

Show the current hello time of the root bridge. Hello time is a time interval specified by root bridge, used to request all other bridges periodically sending hello message every “hello time” seconds to the bridge attached to its designated port.

STP Topology Change Count:

STP Topology Change Count expresses the time spent in unit of seconds since the beginning of the Spanning Tree Topology Change to the end of the STP convergence. Once the STP change is converged, the Topology Change count will be reset to 0. The figures showing in the screen may not be the exact time it spent but very close to, because the time is eclipsing.

Time Since Last Topology Change:

Time Since Last Topology Change is the accumulated time in unit of seconds the STP has been since the last STP Topology Change was made. When Topology Change is initiated again, this counter will be reset to 0. And it will also count again once STP topology Change is completed.

3-14-2. STP Configuration

The STP, Spanning Tree Protocol, actually includes RSTP. In the Spanning Tree Configuration, there are six parameters open for the user to configure as user's idea. Each parameter description is listed below.

Function name:

STP Configuration

Function description:

User can set the following Spanning Tree parameters to control STP function enable/disable, select mode RSTP/STP and affect STP state machine behavior to send BPDU in this switch. The default setting of Spanning Tree Protocol is "Disable".

STP Configuration

Spanning Tree Protocol	Enable ▾
Bridge Priority (0-61440)	32768 ▾
Hello Time (1-10 sec)	2
Max. Age (6-40 sec)	20
Forward Delay (4-30 sec)	15
Force Version	RSTP ▾

**Note: $2 * (\text{Forward Delay} - 1) \geq \text{Max Age}$
 $\text{Max Age} \geq 2 * (\text{Hello Time} + 1)$**

Apply

Fig. 3-42

Parameter description:

Spanning Tree Protocol:

Set 802.1W Rapid STP function Enable / Disable. Default is "Disable"

Bridge Priority:

The lower the bridge priority is, the higher priority it has. Usually, the bridge with the highest bridge priority is the root. If you want to have the MSM-6226 as root bridge, you can set this value lower than that of bridge in the LAN. The valid value is 0 ~ 61440. The default is 32768.

Hello Time:

Hello Time is used to determine the periodic time to send normal BPDU from designated ports among bridges. It decides how long a bridge should send this message to other bridge to tell I am alive. When the MSM-6226 is the root bridge of the LAN, for example, all other bridges

will use the hello time assigned by this switch to communicate with each other. The valid value is 1 ~ 10 in unit of second.

Default is 2 seconds.

Max. Age:

When the MSM-6226 is the root bridge, the whole LAN will apply this figure set by this switch as their maximum age time. When a bridge received a BPDU originated from the root bridge and if the message age conveyed in the BPDU exceeds the Max. Age of the root bridge, the bridge will treat the root bridge malfunctioned and issue a Topology Change Notification (TCN) BPDU to all other bridges. All bridges in the LAN will re-calculate and determine who the root bridge is. The valid value of Max. Age is 6 ~ 40 seconds. Default is 20 seconds.

Forward Delay:

You can set the root bridge forward delay time. This figure is set by root bridge only. The forward delay time is defined as the time spent from Listening state moved to Learning state and also from Learning state moved to Forwarding state of a port in bridge. The forward delay time contains two states, Listening state to Learning state and Learning state to Forwarding state. It assumes that forward delay time is 15 seconds, then total forward delay time will be 30 seconds. This has much to do with the STP convergent time which will be more than 30 seconds because some other factors.

The valid value is 4 ~ 30 seconds, default is 15 seconds.

Force Version:

Two options are offered for the user's choosing STP algorithm. One is RSTP and the other is STP. If STP is chosen, RSTP will run as a legacy STP. The switch supports RSTP (802.1w) which is backward compatible with STP (802.1d).

3-14-3. STP Port Configuration

Function name:

STP Port Setting

Function description:

In the STP Port Setting, one item selection and five parameters settings are offered for user's setup. User can disable and enable each port by selecting each Port Status item. User also can set "Path Cost" and "Priority" of each port by filling in the desired value and set "Admin Edge Port" and "Admin Point To Point" by selecting the desired item.

STP Port Configuration

Port No	Port Status	Path Cost Status	Configured Path Cost	Priority	Admin Port Type	Admin Point To Point
1	FORWARDING	200000	0	128	Normal	Auto
2	FORWARDING	200000	0	128	Normal	Auto
3	FORWARDING	200000	0	128	Normal	Auto
4	FORWARDING	200000	0	128	Normal	Auto
5	FORWARDING	200000	0	128	Normal	Auto
6	FORWARDING	200000	0	128	Normal	Auto
7	FORWARDING	200000	0	128	Normal	Auto
8	FORWARDING	200000	0	128	Normal	Auto

Fig. 3-43

Parameter description:

Port Status:

It displays the current state of a port. We cannot manually set it because it displays the status only. There are three possible states. (according to 802.1w specification)

- DISCARDING state indicates that this port can neither forward packets nor contribute learning knowledge.

Notice: Three other states (Disable state, BLOCKING state and LISTENING state) defined in the 802.1d specification are now all represented as DISCARDING state.

- LEARNING state indicates this port can now contribute its learning knowledge but cannot forward packets still.
- FORWARDING state indicates this port can both contribute its learning knowledge and forward packets normally.

Path Cost Status:

It is the contribution value of the path through this port to Root Bridge. STP algorithm determines a best path to Root Bridge by calculating the sum of path cost contributed by all ports on this path. A port with a smaller path cost value would become the Root Port more possibly.

Configured Path Cost:

The range is 0 – 200,000,000. In the switch, if path cost is set to be zero, the STP will get the recommended value resulted from auto-negotiation of the link accordingly and display this value in the field of Path Cost Status. Otherwise, it may show the value that the administrator set up in Configured Path Cost and Path Cost Status.

802.1w RSTP recommended value: (Valid range: 1 – 200,000,000)

10 Mbps : 2,000,000

100 Mbps : 200,000

1 Gbps : 20,000

Default: 0

Priority:

Priority here means Port Priority. Port Priority and Port Number are mixed to form the Port ID. Port IDs are often compared in order to determine which port of a bridge would become the Root Port. The range is 0 – 240.

Default is 128.

Admin Edge Port:

If user selects “Yes”, this port will be an edge port. An Edge Port is a port connected to a device that knows nothing about STP or RSTP. Usually, the connected device is an end station. Edge Ports will immediately transit to forwarding state and skip the listening and learning state because the edge ports cannot create bridging loops in the network. This will expedite the convergence. When the link on the edge port toggles, the STP topology keeps unchanged. Unlike the designate port or root port though, an edge port will transit to a normal spanning-tree port immediately if it receives a BPDU.

Default: No

Admin Point To Point:

We say a port is a point-to-point link, from RSTP’s view, if it is in full-duplex mode but is shared link if it is in half-duplex mode. RSTP fast convergence can only happen on point-to-point links and on edge ports. This can expedite the convergence because this will have the port fast transitioned to forwarding state.

There are three parameters, Auto, True and False, used to configure the type of the point-to-point link. If configure this parameter to be Auto, it means RSTP will use the duplex mode resulted from the auto-negotiation. In today’s switched networks, most links are running in full-duplex mode. For sure, the result may be half-duplex, in this case, the port will not fast transit to Forwarding state. If it is set as True, the port is treated as point-to-point link by RSTP and unconditionally transitioned to Forwarding state. If it is set as False, fast transition to Forwarding state will not happen on

this port.

Default: Auto

M Check:

Migration Check. It forces the port sending out an RSTP BPDU instead of a legacy STP BPDU at the next transmission. The only benefit of this operation is to make the port quickly get back to act as an RSTP port. Click **<M Check>** button to send a RSTP BPDU from the port you specified.

3-15. MSTP Configuration

The implementation of MSTP is according to IEEE 802.1Q 2005 Clause 13 – Multiple Spanning Tree Protocol. MSTP allows frames assigned to different VLANs to follow separate paths, each based on an independent Multiple Spanning Tree Instance (MSTI), within Multiple Spanning Tree (MST) Regions composed of LANs and or MST Bridges. Proper configuration of MSTP in an 802.1Q VLAN environment can ensure a loop-free data path for a group of vlans within an MSTI. Redundant path and load balancing in vlan environment is also achieved via this feature. A spanning tree instance called CIST (Common and Internal Spanning Tree) always exists. Up to 64 more spanning tree instances (MSTIs) can be provisioned.

3-15-1 Status

Function name:

MSTP State

Function description:

To enable or disable MSTP. And to select a version of Spanning Tree protocol which MSTP should operate on.

MSTP State



Multiple Spanning Tree Protocol	Enable
Force Version	MSTP

Apply

Fig. 3-43.1

Parameter description:

Multiple Spanning Tree Protocol:

Disabled / Enabled

Force Version:

STP / RSTP / MSTP

3-15-2 Region Config

Function name:

MSTP Region Config

Function description:

To configure the basic identification of a MSTP bridge. Bridges participating in a common MST region must have the same Region Name and Revision Level.

MSTP Region Config

Region Name (0~32 characters)	<input type="text" value="mstpRegion1"/>
Revision Level (0-65535)	<input type="text" value="0"/>

Fig. 3-43.2

Parameter description:

Region Name:

0-32 characters.(A variable length text string encoded within a fixed field of 32 octets , conforming to RFC 2271's definition of SnmpAdminString.)

Revision Level:

0-65535

3-15-3 Instance View

Function name:

MSTP Instance Config

Function description:

Providing an MST instance table which include information(vlan membership of a MSTI) of all spanning instances provisioned in the particular MST region which the bridge belongs to. Through this table, additional MSTP configuration data can be applied and MSTP status can be retrieved.

MSTP Instance Config

Instance ID	Corresponding Vlans
0	1-4094

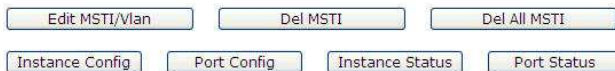

Fig. 3-43.3

Parameter description:

Instance ID:

Every spanning tree instance need to have a unique instance ID within 0~4095. Instance 0 (CIST) always exists and can not be deleted. Additional spanning instances (MSTIs) can be added or deleted. At least one vlan must be provisioned for an MSTI to declare the need for the MSTI to be existent.

Corresponding Vlans:

0-4095.

Multiple vlans can belong to an MSTI. All vlans that are not provisioned through this will be automatically assigned to Instance 0(CIST).

Edit MSTI / Vlan: Fig. 3-43.4

To add an MSTI and provide its vlan members or modify vlan members for a specific MSTI.

Del MSTI:

To delete an MSTI.

Del All MSTI:

Deleting all provisioned MSTIs at a time.

Instance Configuration: Fig. 3-43.5

To provision spanning tree performance parameters per instance.

Port Config: Fig. 3-43.4

To provision spanning tree performance parameters per instance per port.

Instance Status: Fig. 3-43.5

To show the status report of a particular spanning tree instance.

Port Status: Fig. 3-43.5

To show the status report of all ports regarding a specific spanning tree instance.

MSTP Create MSTI/Add Vlan Mapping

Instance ID (1-4094)	<input type="text"/>
Vlan Mapping (VID STRING)	<input type="text"/>
VID STRING Example	2.5-7.100-200.301.303.1000-1500 (Valid VID Range:1-4094)

Fig. 3-43.4 Edit MSTI / Vlan

Parameter description:

Vlan Mapping:

VID STRING

VID STRING Example:

2.5-7.100-200.301.303.1000-1500 (Valid VID Range:1-4094)

Instance Configuration (ID=0)

Priority (0-61440)	32768
Max. Age (6-40 sec)	20
Forward Delay (4-30 sec)	15
Max. Hops(6-40 sec)	20

Note: 2*(Forward Delay -1) >= Max Age

Max Age: available from 6 to 40. Recommended value is 20

Forward Delay(sec): available from 4 to 30. Recommended value is 15

Max Hops: available from 6 to 40. Recommended value is 20

Apply

Fig. 3-43.5 Instance Config

Parameter description:

Priority: The priority parameter used in the CIST(Common and Internal Spanning Tree) connection.

0 / 4096 / 8192 / 12288 / 16384 / 20480 / 24576 / 28672 / 32768 / 36864 / 40960 / 45056 / 49152 / 53248 / 57344 / 61440

MAX. Age:

6-40sec. The same definition as in the RSTP protocol.

Forward Delay:

4-30sec. The same definition as in the RSTP protocol.

MAX. Hops:

6-40sec. It's a new parameter for the multiple spanning tree protocol. It is used in the internal spanning tree instances. "CIST Remaining Hops" or "MSTI Remaining Hops" in the Spanning tree protocol message would be decreased by one when the message is propagated to the neighboring bridge. If the Remaining Hops in a message is zero, the message (BPDU) would be regarded as invalid. Max Hops is used to specify the initial value of the Remaining Hops for Regional Root Bridge (Either CIST Regional Root or MSTI Regional Root)

Port Config of Instance 0

Port Config								Migration Check
Port	Path Cost	Priority	Hello Time	Admin Edge	Admin P2P	Restricted Role	Restricted TCN	Mcheck
1	0	128	2	Yes	Auto	No	No	---
2	0	128	2	Yes	Auto	No	No	---
3	0	128	2	Yes	Auto	No	No	---
4	0	128	2	Yes	Auto	No	No	---
5	0	128	2	Yes	Auto	No	No	---
6	0	128	2	Yes	Auto	No	No	---
7	0	128	2	Yes	Auto	No	No	---
8	0	128	2	Yes	Auto	No	No	---

Fig. 3-43.6 Port Config

Parameter description:

Port:

1-24

Path Cost:

1 – 200,000,000

The same definition as in the RSTP specification. But in MSTP, this parameter can be respectively applied to ports of CIST and ports of any MSTI.

Priority:

0 / 16 / 32 / 48 / 64 / 80 / 96 / 112 / 128 / 144 / 160 / 176 / 192 / 208 / 224 / 240

The same definition as in the RSTP specification. But in MSTP, this parameter can be respectively applied to ports of CIST and ports of any MSTI.

Hello Time:

1 / 2

In contrast with RSTP, Hello Time in MSTP is a per port setting for the CIST.

Admin Edge:

Yes / No

The same definition as in the RSTP specification for the CIST ports.

Admin P2P:

Auto / True / False

The same definition as in the RSTP specification for the CIST ports.

Restricted Role:

Yes / No

If "Yes" causes the Port not to be selected as Root Port for the CIST or any MSTI, even it has the best spanning tree priority vector. Such a Port will be selected as an Alternate Port after the Root Port has been selected. This parameter is "No" by default. If set, it can cause lack of spanning tree connectivity. It is set by a network administrator to prevent bridges external to a core region of the network influencing the spanning tree active topology, possibly because those bridges are not under the full control of the administrator.

Restricted TCN:

Yes / No

If "Yes" causes the Port not to propagate received topology change notifications and topology changes to other Ports. This parameter is "No" by default. If set it can cause temporary loss of connectivity after changes in a spanning trees active topology as a result of persistent incorrectly learned station location information. It is set by a network administrator to prevent bridges external to a core region of the network, causing address flushing in that region, possibly because those bridges are not under the full control of the administrator. or the status of MAC operation for the attached LANs transitions frequently.

Mcheck:

The same definition as in the RSTP specification for the CIST ports.

Instance Status (ID=0)

MSTP State	Enabled
Force Version	MSTP
Bridge Max Age	20
Bridge Forward Delay	15
Bridge Max Hops	20
Instance Priority	32768
Bridge Mac Address	00:01:c1:00:00:00
CIST ROOT PRIORITY	32768
CIST ROOT MAC	00:01:c1:00:00:00
CIST EXTERNAL ROOT PATH COST	0
CIST ROOT PORT ID	0
CIST REGIONAL ROOT PRIORITY	32768
CIST REGIONAL ROOT MAC	00:01:c1:00:00:00
CIST INTERNAL ROOT PATH COST	0
CIST CURRENT MAX AGE	20
CIST CURRENT FORWARD DELAY	15
TIME SINCE LAST TOPOLOGY CHANGE (SECs)	6
TOPOLOGY CHANGE COUNT(SECs)	0

Fig. 3-43.7 Instance Status

Parameter description:

MSTP State:

MSTP protocol is Enable or Disable.

Force Version:

It shows the current spanning tree protocol version configured.

Bridge Max Age:

It shows the Max Age setting of the bridge itself.

Bridge Forward Delay:

It shows the Forward Delay setting of the bridge itself.

Bridge Max Hops:

It shows the Max Hops setting of the bridge itself.

Instance Priority:

Spanning tree priority value for a specific tree instance(CIST or MSTI)

Bridge Mac Address:

The Mac Address of the bridge itself.

CIST ROOT PRIORITY:

Spanning tree priority value of the CIST root bridge

CIST ROOT MAC:

Mac Address of the CIST root bridge

CIST EXTERNAL ROOT PATH COST:

Root path cost value from the point of view of the bridge's MST region.

CIST ROOT PORT ID:

The port ID of the bridge's root port. In MSTP, peer port of a root port may reside in different MST region or in the same MST region. The first case indicates that the root port's owner is the CIST regional root bridge.

CIST REGIONAL ROOT PRIORITY:

Spanning tree priority value of the CIST regional root bridge. Note that CIST Regional Root bridge is different from CIST Root bridge. One exception is that when a bridge belonging to an MST region happens to be the root bridge of the CST (Common Spanning Tree). An MST Region in the CST can be regarded as a common RSTP bridge. The IST (Internal Spanning Tree) and MSTIs are transparent to bridges outside this region.

CIST REGIONAL ROOT MAC:

Mac Address of the CIST regional root bridge.

CIST INTERNAL ROOT PATH COST:

Root path cost value from the point of view of the bridges inside the IST.

CIST CURRENT MAX AGE:

Max Age of the CIST Root bridge.

CIST CURRENT FORWARD DELAY:

Forward Delay of the CIST Root bridge.

TIME SINCE LAST TOPOLOGY CHANGE(SECs):

Time Since Last Topology Change is the elapsed time in unit of seconds for a bunch of "Topology Change and(or) Topology Change Notification receiving" to occur. When new series of Topology Changes occur again, this counter will be reset to 0.

TOPOLOGY CHANGE COUNT(SECs):

The per spanning tree instance Topology Change Count expresses the time spent in unit of seconds since the beginning of the Spanning Tree Topology Change to the end of the STP convergence. Once there is no topology change occurring and no more topology change notification received, the Topology Change count will be reset to 0.

Port Status of Instance 0

Port No	Status	Role	Path Cost	Priority	Hello	Oper. Edge	Oper. P2P	Restricted Role	Restricted Tcn
1	DISCARDING	dsbl	2000000	128	2/2	V			
2	DISCARDING	dsbl	2000000	128	2/2	V			
3	FORWARDING	DSGN	20000	128	2/2	V	V		
4	DISCARDING	dsbl	2000000	128	2/2	V			
5	DISCARDING	dsbl	2000000	128	2/2	V			

Fig. 3-43.8 Port Status

Parameter description:

Port No:

1-24

Status:

The forwarding status. Same definition as of the RSTP specification
Possible values are "FORWARDING", "LEARNING", "DISCARDING"

Status:

The role that a port plays in the spanning tree topology. Possible values are "dsbl"(disable port), "alt"(alternate port), "bkup"(backup port), "ROOT"(root port), "DSGN"(designated port), "MSTR"(master port). The last 3 are possible port roles for a port to transit to FORWARDING state

Path Cost:

Display currently resolved port path cost value for each port in a particular spanning tree instance.

Priority:

Display port priority value for each port in a particular spanning tree instance.

Hello:

per port Hello Time display. It takes the following form:

Current Hello Time/Hello Time Setting

Oper. Edge:

Whether or not a port is an Edge Port in reality.

Oper. P2P:

Whether or not a port is a Point-to-Point Port in reality.

Restricted Role:

Same as mentioned in "Port Config"

Restricted Tcn:

Same as mentioned in "Port Config"

3-16. Trunking Configuration

The Port Trunking Configuration is used to configure the settings of Link Aggregation. You can bundle more than one port with the same speed, full duplex and the same MAC to be a single logical port, thus the logical port aggregates the bandwidth of these ports. This means you can apply your current Ethernet equipments to build the bandwidth aggregation. For example, if there are three Fast Ethernet ports aggregated in a logical port, then this logical port has bandwidth three times as high as a single Fast Ethernet port has.

The switch supports two kinds of port trunking methods:

LACP:

Ports using Link Aggregation Control Protocol (according to IEEE 802.3ad specification) as their trunking method can choose their unique LACP GroupID (1~3) to form a logic “trunked port”. The benefit of using LACP is that a port makes an agreement with its peer port before it becomes a ready member of a “trunk group” (also called aggregator). LACP is safer than the other trunking method - static trunk.

The switch LACP does not support the followings:

- Link Aggregation across switches
- Aggregation with non-IEEE 802.3 MAC link
- Operating in half-duplex mode
- Aggregate the ports with different data rates

Static Trunk:

Ports using Static Trunk as their trunk method can choose their unique Static GroupID (also 1~3, this Static groupID can be the same with another LACP groupID) to form a logic “trunked port”. The benefit of using Static Trunk method is that a port can immediately become a member of a trunk group without any handshaking with its peer port. This is also a disadvantage because the peer ports of your static trunk group may not know that they should be aggregate together to form a “logic trunked port”. Using Static Trunk on both end of a link is strongly recommended. Please also note that low speed links will stay in “not ready” state when using static trunk to aggregate with high speed links.

As to system restrictions about the port aggregation function on the switch, In the management point of view, the switch supports maximum 3 trunk groups for LACP and additional 3 trunk groups for Static Trunk. But in the system capability view, only 3 “real trunked” groups are supported. An LACP trunk group with more than one ready member-ports is a “real trunked” group. An LACP trunk group with only one or less than one ready member-ports is not a “real trunked” group. Any Static trunk group is a “real trunked” group.

Per Trunking Group supports a maximum of 4 ready member-ports. Please note that some decisions will automatically be made by the system while you are configuring your trunking ports. Trunk Setting Rules are listed below:

Rule1: Maximum 3 groups are allowed

Rule 2: The members of each group cannot exceed more than 4 ports

Rule 3: Group 1 and 2 cannot exist member 25 and 26 port

Rule 4: Group 3 cannot exist member from 1 to 24 port

Function name:

Port Setting/Status

Function description:

Port setting/status is used to configure the trunk property of each and every port in the switch system.

Trunk Port Setting/Status

Trunk Port Setting				Trunk Port Status	
Port	Method	Group	Active LACP	Aggtr	Status
1	None ▾	0 ▾	Active ▾	1	Ready
2	None ▾	0 ▾	Active ▾	2	---
3	None ▾	0 ▾	Active ▾	3	---
4	None ▾	0 ▾	Active ▾	4	---
5	None ▾	0 ▾	Active ▾	5	---
6	None ▾	0 ▾	Active ▾	6	---
7	None ▾	0 ▾	Active ▾	7	---
8	None ▾	0 ▾	Active ▾	8	---

Fig.3- 44

Parameter description:

Method:

This determines the method a port uses to aggregate with other ports.

None:

A port does not want to aggregate with any other port should choose this default setting.

LACP:

A port use LACP as its trunking method to get aggregated with other ports also using LACP.

Static:

A port use Static Trunk as its trunking method to get aggregated with other ports also using Static Trunk.

Group:

Ports choosing the same trunking method other than "None" must be assigned a unique Group number (i.e. Group ID, valid value is from 1 to 8) in order to declare that they wish to aggregate with each other.

Active LACP:

This field is only referenced when a port's trunking method is LACP.

Active:

An Active LACP port begins to send LACPDU to its link partner right after the LACP protocol entity started to take control of this port.

Passive:

A Passive LACP port will not actively send LACPDU out before it receives an LACPDU from its link partner.

Aggtr:

Aggtr is an abbreviation of "aggregator". Every port is also an aggregator, and its own aggregator ID is the same as its own Port No. We can regard an aggregator as a representative of a trunking group. Ports with same Group ID and using same trunking method will have the opportunity to aggregate to a particular aggregator port. This aggregator port is usually the port with the smallest Port No. within the trunking group.

Status:

This field represents the trunking status of a port which uses a trunking method other than "None". It also represents the management link status of a port which uses the "None" trunking method. "---" means "not ready"

Function name:

Aggregator View

Function description:

To display the current port trunking information from the aggregator point of view.

Aggregator View

Aggregator	Method	Member Ports	Ready Ports
1	None	1	1
2	None	2	
3	None	3	
4	None	4	
5	None	5	
6	None	6	
7	None	7	

Fig.3-45

Parameter description:

Aggregator:

It shows the aggregator ID (from 1 to 26) of every port. In fact, every port is also an aggregator, and its own aggregator ID is the same as its own Port No..

Method:

Show the method a port uses to aggregate with other ports.

Member Ports:

Show all member ports of an aggregator (port).

Ready Ports:

Show only the ready member ports within an aggregator (port).

Function name:

LACP Detail (LACP Aggregator Detailed Information)

Function description:

Show the detailed information of the LACP trunking group.

Aggregator 25 Information

Actor			Partner	
System Priority	MAC Address		System Priority	MAC Address
32768	00-40-c7-f8-00-e5		32768	00-00-00-00-00-00
Port	Key	Trunk Status	Port	Key
25	259	---	25	0

Fig. 3-46

Parameter description:

Actor:

The switch you are watching on.

Partner:

The peer system from this aggregator's view.

System Priority:

Show the System Priority part of a system ID.

MAC Address:

Show the MAC Address part of a system ID.

Port:

Show the port number part of an LACP port ID.

Key:

Show the key value of the aggregator. The key value is determined by the LACP protocol entity and can't be set through management.

Trunk Status:

Show the trunk status of a single member port."---" means "not ready"

Function name:

LACP System Configuration

Function description:

It is used to set the priority part of the LACP system ID. LACP will only aggregate together the ports whose peer link partners are all on a single system. Each system supports LACP will be assigned a globally unique System Identifier for this purpose. A system ID is a 64-bit field comprising a 48-bit MAC Address and 16-bit priority value.

The screenshot shows a configuration window titled "LACP System Configuration". It contains two main input fields. The first is "System Priority" with a text box containing "32768" and a range indicator "(1~65535)". The second is "Hash Method" with a dropdown menu currently showing "DA and SA". Below these fields is a note: "Note: This hash method applies to both LACP and static trunk." At the bottom center of the configuration area is a green "Apply" button.

Fig.3-47

Parameter description:

System Priority:

The System Priority can be set by the user. Its range is from 1 to 65535.
Default: 32768.

LACP Hash Method:

DA+SA, DA and SA are three Hash methods offered for the Link Aggregation of the switch. Packets will decide the path to transmit according to the mode of Hash you choose.

Default: DA and SA

3-17. 802.1x Configuration

802.1x port-based network access control provides a method to restrict users to access network resources via authenticating user's information. This restricts users from gaining access to the network resources through a 802.1x-enabled port without authentication. If a user wishes to touch the network through a port under 802.1x control, he (she) must firstly input his (her) account name for authentication and waits for gaining authorization before sending or receiving any packets from a 802.1x-enabled port.

Before the devices or end stations can access the network resources through the ports under 802.1x control, the devices or end stations connected to a controlled port send the authentication request to the authenticator, the authenticator pass the request to the authentication server to authenticate and verify, and the server tell the authenticator if the request get the grant of authorization for the ports.

According to IEEE802.1x, there are three components implemented. They are Authenticator, Supplicant and Authentication server shown in Fig. 3-41.

Supplicant:

It is an entity being authenticated by an authenticator. It is used to communicate with the Authenticator PAE (Port Access Entity) by exchanging the authentication message when the Authenticator PAE request to it.

Authenticator:

An entity facilitates the authentication of the supplicant entity. It controls the state of the port, authorized or unauthorized, according to the result of authentication message exchanged between it and a supplicant PAE. The authenticator may request the supplicant to re-authenticate itself at a configured time period. Once start re-authenticating the supplicant, the controlled port keeps in the authorized state until re-authentication fails.

A port acting as an authenticator is thought to be two logical ports, a controlled port and an uncontrolled port. A controlled port can only pass the packets when the authenticator PAE is authorized, and otherwise, an uncontrolled port will unconditionally pass the packets with PAE group MAC address, which has the value of 01-80-c2-00-00-03 and will not be forwarded by MAC bridge, at any time.

Authentication server:

A device provides authentication service, through EAP, to an authenticator by using authentication credentials supplied by the supplicant to determine if the supplicant is authorized to access the network resource.

The overview of operation flow for the Fig. 3-41 is quite simple. When Supplicant PAE issues a request to Authenticator PAE, Authenticator and Supplicant exchanges authentication message. Then, Authenticator passes the request to RADIUS server to verify. Finally, RADIUS server replies if the request is granted or denied.

While in the authentication process, the message packets, encapsulated by Extensible Authentication Protocol over LAN (EAPOL), are exchanged between an authenticator PAE and a supplicant PAE. The Authenticator exchanges the message to authentication server using EAP encapsulation. Before successfully authenticating, the supplicant can only touch the authenticator to perform authentication message exchange or access the network from the uncontrolled port.

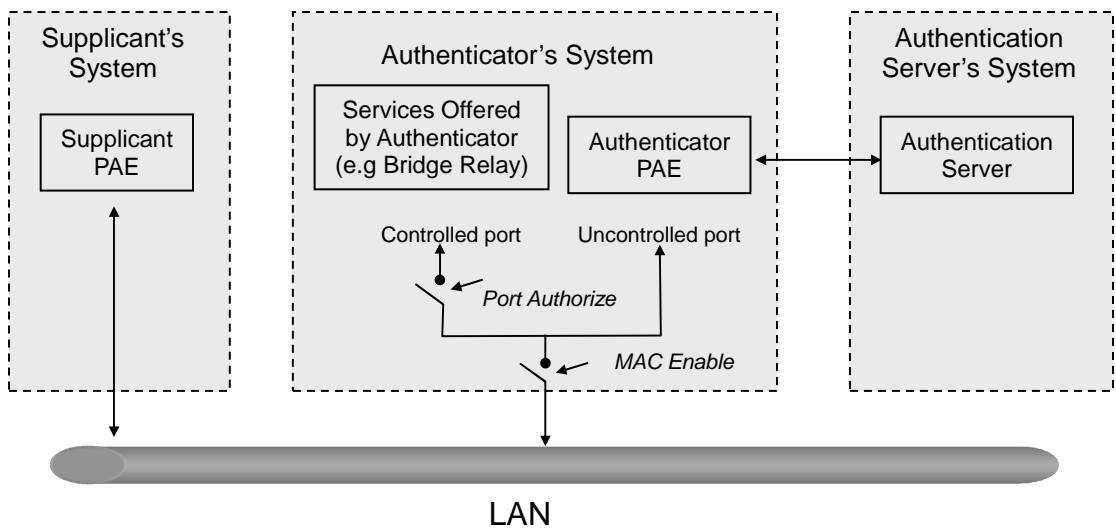
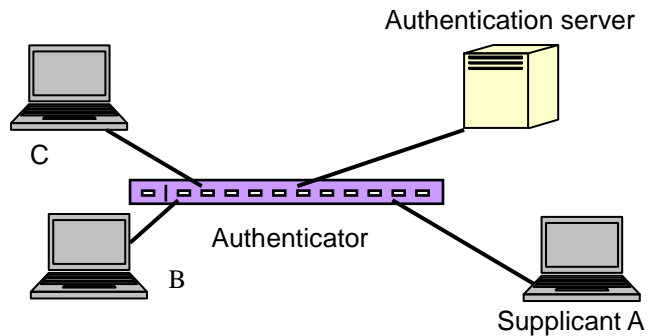

Fig. 3-48

In the Fig. 3-48, this is the typical configuration, a single supplicant, an authenticator and an authentication server. B and C is in the internal network, D is Authentication server running RADIUS, switch at the central location acts Authenticator connecting to PC A and A is a PC outside the controlled port, running Supplicant PAE. In this case, PC A wants to access the services on device B and C, first, it must exchange the authentication message with the authenticator on the port it connected via EAPOL packet. The authenticator transfers the supplicant's credentials to Authentication server for verification. If success, the authentication server will notice the authenticator the grant. PC A, then, is allowed to access B and C via the switch. If there are two switches directly connected together instead of single one, for the link connecting two switches, it may have to act two port roles at the end of the link: authenticator and supplicant, because the traffic is bi-directional.

Fig. 3-49



The Fig. 3-49 shows the procedure of 802.1x authentication. There are steps for the login based on 802.1x port access control management. The protocol used in the right side is EAPOL and the left side is EAP.

1. At the initial stage, the supplicant A is unauthenticated and a port on switch acting as an authenticator is in unauthorized state. So the access is blocked in this stage.
2. Initiating a session. Either authenticator or supplicant can initiate the message exchange. If supplicant initiates the process, it sends EAPOL-start packet to the authenticator PAE and authenticator will immediately respond EAP-Request/Identity packet.
3. The authenticator always periodically sends EAP-Request/Identity to the supplicant for requesting the identity it wants to be authenticated.
4. If the authenticator doesn't send EAP-Request/Identity, the supplicant will initiate EAPOL-Start the process by sending to the authenticator.
5. And next, the Supplicant replies an EAP-Response/Identity to the authenticator. The authenticator will embed the user ID into Radius-Access-Request command and send it to the authentication server for confirming its identity.
6. After receiving the Radius-Access-Request, the authentication server sends Radius-Access-Challenge to the supplicant for asking for inputting user password via the authenticator PAE.
7. The supplicant will convert user password into the credential information, perhaps, in MD5 format and replies an EAP-Response with this credential information as well as the specified authentication algorithm (MD5 or OTP) to Authentication server via the authenticator PAE. As per the value of the type field in message PDU, the authentication server knows which algorithm should be applied to authenticate the credential information, EAP-MD5 (Message Digest 5) or EAP-OTP (One Time Password) or other else algorithm.

8. If user ID and password is correct, the authentication server will send a Radius-Access-Accept to the authenticator. If not correct, the authentication server will send a Radius-Access-Reject.
9. When the authenticator PAE receives a Radius-Access-Accept, it will send an EAP-Success to the supplicant. At this time, the supplicant is authorized and the port connected to the supplicant and under 802.1x control is in the authorized state. The supplicant and other devices connected to this port can access the network. If the authenticator receives a Radius-Access-Reject, it will send an EAP-Failure to the supplicant. This means the supplicant is failed to authenticate. The port it connected is in the unauthorized state, the supplicant and the devices connected to this port won't be allowed to access the network.
10. When the supplicant issue an EAP-Logoff message to Authentication server, the port you are using is set to be unauthorized.

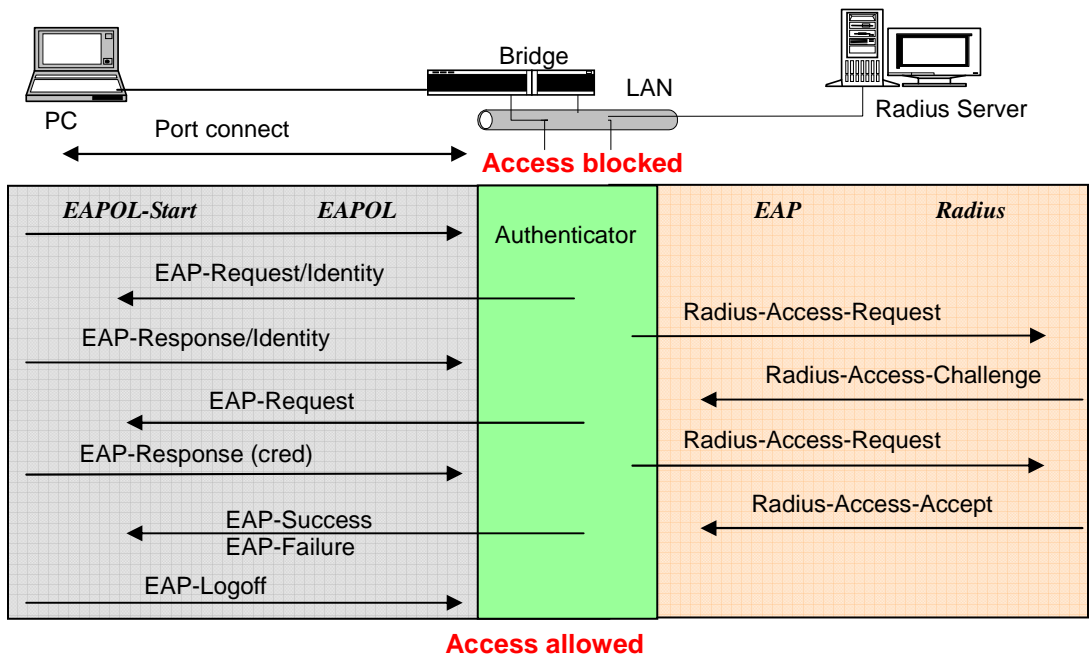

Fig. 3-50

Only MultiHost 802.1X is the type of authentication supported in the switch. In this mode, for the devices connected to this port, once a supplicant is authorized, the devices connected to this port can access the network resource through this port.

802.1x Port-based Network Access Control function supported by the switch is little bit complex, for it just support basic Multihost mode, which can distinguish the device's MAC address and its VID. The following table is the summary of the combination of the authentication status and the port status versus the status of port mode, set in 802.1x Port mode, port control state, set in 802.1x port setting. Here Entry Authorized means MAC entry is authorized.

Port Mode	Port Control	Authentication	Port Status
Disable	Don't Care	Don't Care	Port Uncontrolled
Multihost	Auto	Successful	Port Authorized
Multihost	Auto	Failure	Port Unauthorized
Multihost	ForceUnauthorized	Don't Care	Port Unauthorized
Multihost	ForceAuthorized	Don't Care	Port Authorized

Table 3-3

Function name:

802.1x State Setting

Function description:

This function is used to configure the global parameters for RADIUS authentication in 802.1x port security application.

802.1X State Setting

Radius Server 1	192.168.1.1
Port Number(1~65535)	1812
Radius Server 2	192.168.1.1
Port Number(1~65535)	1812
Secret Key	Radius
Accounting Service	Enable
Accounting Server 1	192.168.1.1
Accounting Port(1~65535)	1813
Accounting Server 2	192.168.1.1
Accounting Port(1~65535)	1813
Secret Key	Radius

Apply

Fig. 3-51

Parameter description:

Radius Server:

RADIUS server IP address for authentication.

Default: 192.168.1.1

Port Number:

The port number to communicate with RADIUS server for the authentication service. The valid value ranges 1-65535.

Default port number is 1812.

Secret Key:

The secret key between authentication server and authenticator. It is a string with the length 1 – 31 characters. The character string may contain upper case, lower case and 0-9. It is character sense. It is not allowed for putting a blank between any two characters.

Default: Radius

Function name:

802.1x Mode Setting

Function description:

Set the operation mode of 802.1X for each port. In this device, it supports Normal and Advanced 802.1X mode.

802.1X Mode Setting

Port	802.1X Mode
1	Disable
2	Disable
3	Normal
4	Advanced 802.1X
5	Disable
6	Disable
7	Disable
8	Disable
9	Disable

Fig. 3-52

Parameter description:

Port Number:

Indicate which port is selected to configure the 802.1x operation mode.

802.1x Mode:

802.1x operation mode. There are two options, including Disable and Multi-host mode. Default is Disable.

- Disable

It will have the chosen port acting as a plain port, that is no 802.1x port access control works on the port.

- Normal

It will have the chosen port acting as a plain port, that is normal 802.1x port access control works on the port.

- Advanced 802.1X

In Advanced 802.1X mode, for the devices connected to this port, once a supplicant is authorized, the devices connected to this port can access the network resource through this port.

Function name:

Port Security Management

Function description:

Shows each port status. In Multihost mode, it shows the port number and its status, authorized or unauthorized.

Port Security Management

Port	Mode	Status
1	disable	
2	disable	
3	disable	
4	disable	
5	disable	
6	disable	
7	disable	
8	disable	

Fig. 3-53

Parameter description:

Disable Mode:

When selecting Disable mode for a port in the function 802.1X Port Mode Configuration, the port is in the uncontrolled port state and does not apply 802.1X authenticator on it. Any node attached on this port can access the network without the admittance of 802.1X authenticator. The Port Status will show the following screen.

Port Number:

The port number to be chosen to show its 802.1X Port Status. The valid number is Port 1 – 26.

Port Status:

The current 802.1X status of the port. In Disable mode, this field is Disabled.

802.1x with Multihost mode:

When selecting 802.1x with Multihost mode for a port in the function 802.1X Port Mode Configuration, Devices can access the network through this port once the authenticator is authorized. The Port Status will show the following screen. If the port is granted to access the network, the port status is authorized, otherwise, unauthorized.

Function name:

Param. Setting

Function description:

This function is used to configure the parameters for each port in 802.1x port security application. Refer to the following parameters description for details.

Port Parameter Setting

Port	3
Port Control	Auto
reAuthMax(1-10)	2
txPeriod(1-65535 s)	30
Quiet Period(0-65535 s)	60
reAuthEnabled	ON
reAuthPeriod(1-65535 s)	120
max. Request(1-10)	2
suppTimeout(1-255 s)	30
serverTimeout(1-255 s)	30

Apply

Fig. 3-54

Parameter description:

Port:

It is the port number to be selected for configuring its associated 802.1x parameters which are Port control, reAuthMax, txPeriod, Quiet Period, reAuthEnabled, reAuthPeriod, max. Request, suppTimeout, serverTimeout and Controlled direction.

Port Control:

This is used to set the operation mode of authorization. There are three type of operation mode supported, ForceUnauthorized, ForceAuthorized, Auto.

- ForceUnauthorized:
The controlled port is forced to hold in the unauthorized state.
- ForceAuthorized:
The controlled port is forced to hold in the authorized state.

- Auto:

The controlled port is set to be in authorized state or unauthorized state depends on the result of the authentication exchange between the authentication server and the supplicant.

Default: Auto

reAuthMax(1-10):

The number of authentication attempt that is permitted before the port becomes unauthorized.

Default: 2

txPeriod(1-65535 s):

A time period to transmitted EAPOL PDU between the authenticator and the supplicant.

Default: 30

Quiet Period(0-65535 s):

A period of time during which we will not attempt to access the supplicant.

Default: 60 seconds

reAuthEnabled:

Choose whether regular authentication will take place in this port.

Default: ON

reAuthPeriod(1-65535 s):

A non-zero number seconds between the periodic re-authentication of the supplicant.

Default: 3600

max. Request(1-10):

The maximum of number times that the authenticator will retransmit an EAP Request to the supplicant before it times out the authentication session. The valid range: 1 – 10.

Default: 2 times

suppTimeout(1-65535 s):

A timeout condition in the exchange between the authenticator and the supplicant. The valid range: 1 –65535.

Default: 30 seconds.

serverTimeout(1-65535 s):

A timeout condition in the exchange between the authenticator and the authentication server. The valid range: 1 –65535.

Default: 30 seconds

3-18. Alarm Configuration

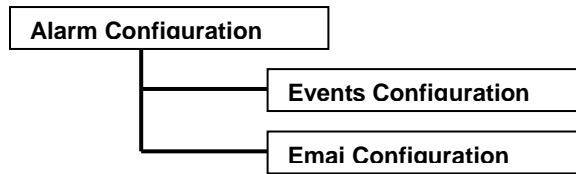

Function name:

Events Configuration

Function description:

The Trap Events Configuration function is used to enable the switch to send out the trap information while pre-defined trap events occurred. The switch offers 21 different trap events to users for switch management. The trap information can be sent out in tow ways, including email and trap. The message will be sent while users tick (☑) the trap event individually on the web page shown as below.

Trap Events Configuration

Email Select/Unselect All
Trap Select/Unselect All

Event	Email	Trap
Cold Start	<input type="checkbox"/>	<input checked="" type="checkbox"/>
Warm Start	<input type="checkbox"/>	<input checked="" type="checkbox"/>
Link Down	<input type="checkbox"/>	<input checked="" type="checkbox"/>
Link Up	<input type="checkbox"/>	<input checked="" type="checkbox"/>
Authentication Failure	<input type="checkbox"/>	<input checked="" type="checkbox"/>
User Login	<input type="checkbox"/>	<input type="checkbox"/>
User Logout	<input type="checkbox"/>	<input type="checkbox"/>
STP Topology Changed	<input type="checkbox"/>	<input type="checkbox"/>
STP Disabled	<input type="checkbox"/>	<input type="checkbox"/>
STP Enabled	<input type="checkbox"/>	<input type="checkbox"/>
LACP Disabled	<input type="checkbox"/>	<input type="checkbox"/>

Fig. 3-55

Parameter description:

Trap: Cold Start, Warm Start, Link Down, Link Up, Authentication Failure, User login, User logout

STP: STP Topology Changed, STP Disabled, STP Enabled

LACP: LACP Disabled, LACP Enabled, LACP Member Added, LACP Port Failure

GVRP: GVRP Disabled, GVRP Enabled

VLAN: Port-based VLAN Enabled, Tag-based VLAN Enabled

Module Swap: Module Inserted, Module Removed, Dual Media Swapped

Function name:

Email Configuration

Function description:

Alarm configuration is used to configure the persons who should receive the alarm message via either email. It depends on your settings. An email address has to be set in the web page of alarm configuration (See Fig. 3-49). Then, user can read the trap information from the email. This function provides 6 email addresses. The 21 different trap events will be sent out to SNMP Manager when trap event occurs. After ticking trap events, you can fill in your desired email addresses. Then, please click **<Apply>** button to complete the alarm configuration. It will take effect in a few seconds.

Alarm Configuration

Mail Server	<input type="text"/>
Username	<input type="text"/>
Password	<input type="text"/>
Email Address 1	<input type="text"/>
Email Address 2	<input type="text"/>
Email Address 3	<input type="text"/>
Email Address 4	<input type="text"/>
Email Address 5	<input type="text"/>
Email Address 6	<input type="text"/>

Fig. 3-56

Parameter description:

Email:

Mail Server: the IP address of the server transferring your email.

Username: your username on the mail server.

Password: your password on the mail server.

Email Address 1 – 6: email address that would like to receive the alarm message.

3-19. Configuration

The switch supports three copies of configuration, including the default configuration, working configuration and user configuration for your configuration management. All of them are listed and described below respectively.

▪ **Default Configuration:**

This is Manufacture's setting and cannot be altered. In Web UI, two restore default functions are offered for the user to restore to the default setting of the switch. One is the function of "Restore Default Configuration included default IP address", the IP address will restore to default "192.168.1.1" as you use it. The other is the function of "Restore Default Configuration without changing current IP address", the IP address will keep the same one that you had saved before by performing this function.

▪ **Working Configuration:**

It is the configuration you are using currently and can be changed any time. The configurations you are using are saved into this configuration file. This is updated each time as you press **<Apply>** button.

▪ **User Configuration:**

It is the configuration file for the specified or backup purposes and can be updated while having confirmed the configuration. You can retrieve it by performing Restore User Configuration.

Configuration

Save Start	Save as Start Configuration
Save User	Save as User Configuration
Restore Default	Restore Default Configuration including default ip address
Restore Default	Restore Default Configuration without changing current ip address
Restore User	Restore User Configuration

Fig. 3-57

3-19-1. Save/Restore

Function name:

Save As Start Configuration

Function description:

Save the current configuration as a start configuration file in flash memory.



Configuration

Save Start	Save as Start Configuration
Save User	Save as User Configuration
Restore Default	Restore Default Configuration including default ip address
Restore Default	Restore Default Configuration without changing current ip address
Restore User	Restore User Configuration

Fig. 3-58

Function name:

Save As User Configuration

Function description:

Save the current configuration as a user configuration file in flash memory.



Configuration

Save Start	Save as Start Configuration
Save User	Save as User Configuration
Restore Default	Restore Default Configuration including default ip address
Restore Default	Restore Default Configuration without changing current ip address
Restore User	Restore User Configuration

Fig. 3-59

Function name:

Restore Default Configuration (includes default IP address)

Function description:

Restore Default Configuration function can retrieve Manufacture's setting to replace the start configuration. And the IP address of the switch will also be restored to 192.168.1.1.

Restore Default Configuration Successfully

Reboot the system to take effect for the setting?

Reboot

Fig. 3-60

Function name:

Restore Default Configuration (excludes current IP address)

Function description:

Restore Default Configuration function can retrieve Manufacture's setting to replace the start configuration. However, the switch's current IP address that the user set up will not be changed and will NOT be restored to 192.168.1.1 as well.

Restore Default Configuration Successfully

Reboot the system to take effect for the setting?

Reboot

Fig. 3-61

Function name:

Restore User Configuration

Function description:

Restore User Configuration function can retrieve the previous confirmed working configuration stored in the flash memory to update start configuration. When completing to restore the configuration, the system's start configuration is updated and will be changed its system settings after rebooting the system.

Restore User Configuration Successfully

Reboot the system to take effect for the setting?

Reboot

Fig. 3-62

3-19-2. Config File

Function name:

Config File

Function description:

With this function, user can back up or reload the config files of Save As Start or Save As User via TFTP.

Configure Export/Import File Path

TFTP Server IP	0.0.0.0
Export File Path	<input type="text"/>
	<input type="button" value="Export Start"/> <input type="button" value="Export User-Conf"/>
Import File Path	<input type="text"/>
	<input type="button" value="Import Start"/> <input type="button" value="Import User-Conf"/>

Fig. 3-63

Parameter description:

Export File Path:

Export Start:

Export Save As Start's config file stored in the flash.

Export User-Conf:

Export Save As User's config file stored in the flash.

Import File Path:

Import Start:

Import Save As Start's config file stored in the flash.

Import User-Conf:

Import Save As User's config file stored in the flash.

3-20. Security

Function name:

Mirror Configuration

Function description:

Mirror Configuration is to monitor the traffic of the network. For example, we assume that Port A and Port B are Monitoring Port and Monitored Port respectively, thus, the traffic received by Port B will be copied to Port A for monitoring.

Mirror

Mode	Disable ▾							
Monitoring Port	Port 1 ▾							
Monitored Ingress Port	1. <input type="checkbox"/>	2. <input type="checkbox"/>	3. <input type="checkbox"/>	4. <input type="checkbox"/>	5. <input type="checkbox"/>	6. <input type="checkbox"/>	7. <input type="checkbox"/>	8. <input type="checkbox"/>
	9. <input type="checkbox"/>	10. <input type="checkbox"/>	11. <input type="checkbox"/>	12. <input type="checkbox"/>	13. <input type="checkbox"/>	14. <input type="checkbox"/>	15. <input type="checkbox"/>	16. <input type="checkbox"/>
	17. <input type="checkbox"/>	18. <input type="checkbox"/>	19. <input type="checkbox"/>	20. <input type="checkbox"/>	21. <input type="checkbox"/>	22. <input type="checkbox"/>	23. <input type="checkbox"/>	24. <input type="checkbox"/>
	25. <input type="checkbox"/>	26. <input type="checkbox"/>						
Monitored Egress Port	1. <input type="checkbox"/>	2. <input type="checkbox"/>	3. <input type="checkbox"/>	4. <input type="checkbox"/>	5. <input type="checkbox"/>	6. <input type="checkbox"/>	7. <input type="checkbox"/>	8. <input type="checkbox"/>
	9. <input type="checkbox"/>	10. <input type="checkbox"/>	11. <input type="checkbox"/>	12. <input type="checkbox"/>	13. <input type="checkbox"/>	14. <input type="checkbox"/>	15. <input type="checkbox"/>	16. <input type="checkbox"/>
	17. <input type="checkbox"/>	18. <input type="checkbox"/>	19. <input type="checkbox"/>	20. <input type="checkbox"/>	21. <input type="checkbox"/>	22. <input type="checkbox"/>	23. <input type="checkbox"/>	24. <input type="checkbox"/>
	25. <input type="checkbox"/>	26. <input type="checkbox"/>						

Fig. 3-64

Parameter description:

Mode:

Used for the activation or de-activation of Port Mirror function. Default is disable.

Monitoring Port:

Set up the port for monitoring. Valid port is Port 1~26 and default is Port 1.

Monitored Ingress Port:

Set up the port for being monitored. It only monitor the packets received by the port you set up. Just tick the check box () beside the port x and valid port is Port 1~26.

Monitored Egress Port:

Set up the port for being monitored. It only monitor the packets transmitted by the port you set up. Just tick the check box () beside the port x and valid port is Port 1~26.

Function name:

Isolated Group

Function description:

Isolated Group function can let the port be independent of other ports in the Isolated group, and the communication is also forbidden between these ports. But, the ports of the Isolated group are still able to communicate with the ports of the non-Isolated group. With this design, it will be helpful to the administrator to immediately find and solve the port that results in the occurrence of looping problems in the network.

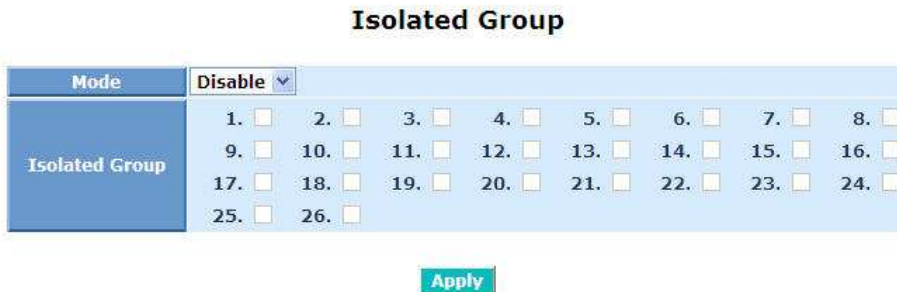

Fig. 3-65

Parameter description:

Mode:

Used for the activation or de-activation of Isolated Group function.
Default is disable

Isolated Group:

User can choose any port to be the member of this group. Just tick the check box (☑) beside the port x and valid port is Port 1~26. In this group, all of these member ports cannot forward packets with each other. Thus, the switch will not be capable of forwarding any packets in case its all ports become the members of the Isolated group.

3-21. Bandwidth

Function name:

Ingress Bandwidth Setting

Function description:

Ingress Bandwidth Setting function is used to set up the limit of Ingress bandwidth for each port.

Ingress Bandwidth Control

FE Ports: 64 - 102400 (Kbps)

GE Ports: 1024 - 1024000 (Kbps)

Port No	Rate(Kb)	Port No	Rate(Kb)
1	102400	2	102400
3	102400	4	102400
5	102400	6	102400
7	102400	8	102400
9	102400	10	102400
11	102400	12	102400
13	102400	14	102400
15	102400	16	102400
17	102400	18	102400
19	102400	20	102400
21	102400	22	102400
23	102400	24	102400
25	1024000	26	1024000

Apply

Fig. 3-66

Parameter description:

Port No.:

Choose the port that you would like this function to work on it. Valid range of the port is 1~26.

Rate:

Set up the limit of Ingress bandwidth for the port you choose. Incoming traffic will be discarded if the rate exceeds the value you set up in Data Rate field. Pause frames are also generated if flow control is enabled. The format of the packet limits to unicast, broadcast and multicast. Valid value of Port 1~24 ranges from 66~102400, and Port 25~26 ranges from 66~1024000 with the minimum unit of 1. Default value of Port 1~24 is 102400 and Port 25~26 is 1024000.

Function name:

Egress Bandwidth Setting

Function description:

Egress Bandwidth Setting function is used to set up the limit of Egress bandwidth for each port.

Egress Bandwidth Control

FE Ports: 64 - 102400 (Kbps)
GE Ports: 1024 - 1024000 (Kbps)

Port No	Rate(Kb)	Port No	Rate(Kb)
1	102400	2	102400
3	102400	4	102400
5	102400	6	102400
7	102400	8	102400
9	102400	10	102400
11	102400	12	102400
13	102400	14	102400
15	102400	16	102400
17	102400	18	102400
19	102400	20	102400
21	102400	22	102400
23	102400	24	102400
25	1024000	26	1024000

Apply

Fig. 3-67

Parameter description:

Port No.:

Choose the port that you would like this function to work on it. Valid range of the port is 1~26.

Rate:

Set up the limit of Egress bandwidth for the port you choose. Packet transmission will be delayed if the rate exceeds the value you set up in Data Rate field. Traffic may be lost if egress buffers run full. The format of the packet limits to unicast, broadcast and multicast. Valid value of Port 1~24 ranges from 66~102400, and Port 25~26 ranges from 66~1024000 with the minimum unit of 1. Default value of Port 1~24 is 102400 and Port 25~26 is 1024000.

Function name:

Storm

Function description:

Bandwidth Management function is used to set up the limit of Ingress and Egress bandwidth for each port.

Storm Control

FE Ports: 64 - 102400 (Kbps)

GE Ports: 1024 - 1024000 (Kbps)

Port	Type	Rate
1	Disable	102400
2	Disable	102400
3	BC,UC	102400
4	MC	102400
5	BC,MC	102400
6	UC,MC	102400
7	BC,UC,MC	102400
8	Disable	102400

Fig. 3-68

Parameter description:

Storm Type:

Disable:

Disable the function of the bandwidth storm control.

BC (Broadcast Storm Control):

Enable the function of bandwidth storm control for broadcast packets.

UC (Unknown Unicast Storm Control):

Enable the function of bandwidth storm control for unknown unicast packets. These packets are the MAC address that had not completed the learning process yet.

BC, UC (Broadcast, Unknown Unicast Storm Control):

Enable the function of bandwidth storm control for broadcast and Unknown Unicast Storm packets in transmission

MC (Multicast Storm Control):

Enable the function of bandwidth storm control for multicast packets.

BC, MC (Broadcast, Multicast Storm Control):

Enable the function of bandwidth storm control for broadcast and multicast Storm packets in transmission.

UC, MC (Unknown Unicast, Multicast Storm Control):

Enable the function of bandwidth storm control for Unknown Unicast and multicast Storm packets in transmission.

BC, UC, MC (Broadcast, Unknown Unicast, Multicast Storm Control):

Enable the function of bandwidth storm control for all packets in transmission.

Rate :

Set up the limit of bandwidth for storm type you choose. Valid value of the storm rate ranges:

FE Ports: 64 - 102400 (Kbps)

GE Ports: 1024 - 1024000 (Kbps).

And only integer is acceptable. Default is 102400.

3-22. QoS(Quality of Service Configuration)

The switch supports 5 kinds of QoS, are as follows, MAC Priority, 802.1p Priority, IP TOS Priority, and DiffServ DSCP Priority. Port Based Priority has a special name called VIP Port in the switch. Any packets enter VIP Port will have highest transmitting priority. MAC Priority act on the destination address of MAC in packets. VLAN tagged Priority field is effected by 802.1p Priority setting. IP TOS Priority affects TOS fields of IP header, and you can find it has 8-bit SERVICE TYPE field that specifies how the datagram should be handled. The field could be divided into six subfields as follows, PRECEDENCE (3 bits), D-Type (Delay Priority, 1 bit), T-Type (Throughput Priority, 1bit), R-Type (Reliability Priority, 1bit), M-Type (Monetary Cost Priority, 1bit), and UNUSED (1bit).

User can randomly control these fields to achieve some special QoS goals. When bits D, T, R, or M set, the D bit requests low delay, the T bit requests high throughput, the R bit requests high reliability, and the M bit requests low cost.

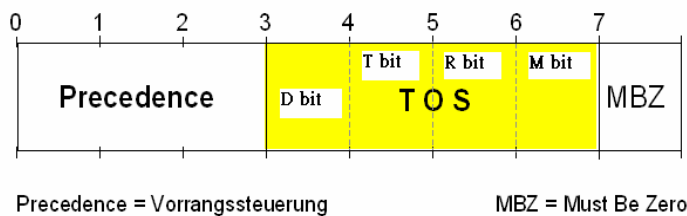

DiffServ DSCP Priority act on DSCP field of IP Header. In the late 1990s, the IETF redefined the meaning of the 8-bit SERVICE TYPE field to accommodate a set of differentiated services (DS). Under the differentiated services interpretation, the first six bits comprise a codepoint, which is sometimes abbreviated DSCP, and the last two bits are left unused.

High Priority Packet streams will experience less delay into the switch. For handing different priority packets, each egress port has designed up to 4 queues. Each QoS is influenced by two scheduling, WRR (Weighted Round Robin) and Strict Priority as well. When you finish to set the priority mapping to the queue, WRR scheduling will distribute the bandwidth according to the weight you set for 4 queues (queue 0 to queue 3). Another scheduling is Strict Priority dedicated for the function named VIP Port of QoS. While we select some ports as the VIP Port, these ports will own the highest transmitting priority in egress queue of the switch.

The QoS functions as we mentioned above are able to be enabled at the same time. But, the following precedence will decide whether these functions work or not.

1. Enable both VIP and TOS. Choose priorities of VIP and TOS.
2. Enable both VIP and DSCP. Choose priorities of VIP and DSCP.
3. Enable both TOS and DSCP. Choose "DSCP".
4. Enable both VIP and DSCP. Choose priorities of VIP and DSCP.
5. Enable both 802.1p and TOS. Choose "TOS".
6. Enable both 802.1p and DSCP. Choose "DSCP".
7. Enable both 802.1p and DSCP and TOS. Choose "DSCP".
8. Enable both 802.1p and DSCP and TOS and VIP. Choose priorities of VIP

and DSCP.

** VIP/DSCP > TOS > 802.1p (Final result)

Function name:

QoS Global Setting

Function description:

When you want to use QoS function, please enable QoS Mode in advance. Then you can use MAC Priority, 802.1p Priority, IP TOS Priority, DiffServ DSCP Priority, or VIP Port functions and take effect. In this function, you can Enable QoS Mode. Choose any of Priority Control, such as 802.1p, TOS, DSCP. Moreover, you can select Scheduling Method of WRR (Weighted Round Robin) or Strict Priority. Next, you can arrange Weight values for queue 0 to queue 3.

QoS Global Config

QoS Mode	Disable ▾		
Priority Control			
802.1P	DSCP		
<input type="checkbox"/>	<input type="checkbox"/>		
Scheduling Method			
4 WRR ▾			
Weight (1-55)			
Queue 0	Queue 1	Queue 2	Queue 3
1	2	4	8

Fig. 3-69

Parameter description:

QoS Mode:

You can Enable QoS Mode and let QoS function become effective. Default is Disable.

Priority Control:

Just tick the check box (☑) of 802.1P, TOS, or DSCP Qos and click Apply button to be in operation.

Scheduling Method:

There are two Scheduling Method, WRR and Strict Priority. Default is WRR. After you choose any of Scheduling Method, please click Apply button to be in operation.

Weight (1~55):

Over here, you can make an arrangement to Weight values of Queue 0 to Queue 3. The range of Weight you can set is 1~55. In default, the weight of Queue 0 is 1, the weight of Queue 1 is 2, the weight of Queue 2 is 4, and the weight of Queue 3 is 8.

Function name:

802.1p Setting

Function description:

This function will affect the priority of VLAN tag. Based on priority of VLAN tag, it can arrange 0~8 priorities, priorities can map to 4 queues of the switch (queue 0~3) and possess different bandwidth distribution according to your weight setting.

802.1p Priority Mapping

Priority	Queue
0	0
1	0
2	1
3	1
4	2
5	2
6	3
7	3

Apply

Fig. 3-70

Parameter description:

802.1p Priority Mapping:

Each Priority can select any of Queue 0 ~ Queue 3. In Default, Priority 0 is mapping to Queue 0, Priority 1 is mapping to Queue 0, Priority 2 is mapping to Queue 1, Priority 3 is mapping to Queue 1, Priority 4 is mapping to Queue 2, Priority 5 is mapping to Queue 2, Priority 6 is mapping to Queue 3, and Priority 7 is mapping to Queue 3.

Function name:

DSCP Setting

Function description:

In the late 1990s, the IETF redefined the meaning of the 8-bit SERVICE TYPE field to accommodate a set of differentiated services (DS). Under the differentiated services interpretation, the first six bits comprise a codepoint, which is sometimes abbreviated DSCP, and the last two bits are left unused.

DSCP can form total 64 (0~63) kinds of Traffic Class based on the arrangement of 6-bit field in DSCP of the IP packet. In the switch, user is allowed to set up these 64 kinds of Class that belong to any of queue 0~3.

DSCP Priority Mapping

Priority	Queue	Priority	Queue	Priority	Queue	Priority	Queue
0	0	1	0	2	0	3	0
4	0	5	0	6	0	7	0
8	0	9	0	10	0	11	0
12	0	13	0	14	0	15	0
16	1	17	1	18	1	19	1
20	1	21	1	22	1	23	1
24	1	25	1	26	1	27	1
28	1	29	1	30	1	31	1
32	2	33	2	34	2	35	2
36	2	37	2	38	2	39	2
40	2	41	2	42	2	43	2
44	2	45	2	46	2	47	2
48	3	49	3	50	3	51	3
52	3	53	3	54	3	55	3
56	3	57	3	58	3	59	3
60	3	61	3	62	3	63	3

Apply

Fig. 3-71

Parameter description:

DSCP Priority Mapping:

64 kinds of priority traffic as mentioned above, user can set up any of Queue 0~3. In default, Priority 0~15 are mapping to Queue 0, Priority 16~31 are mapping to Queue 1, Priority 32~47 are mapping to Queue 2, Priority 48~63 are mapping to Queue 3.

3-23. ACL

The MSM-6226 switch access control list (ACL) is probably the most commonly used object in the IOS. It is used for packet filtering but also for selecting types of traffic to be analyzed, forwarded, or influenced in some way.

The ACLs are divided into EtherTypes. IPv4, ARP protocol, MAC and VLAN parameters etc. Here we will just go over the standard and extended access lists for TCP/IP. As you create ACEs for ingress classification, you can assign a policy for each port, the policy number is 1-8, however, each policy can be applied to any port. This makes it very easy to determine what type of ACL policy you will be working with.

Note: The High-ACL List rule: When you set on the switch, it will apply the ACL rules with the top priority. The High-ACL rules will give the top priority against the other access control rules.

The Low-ACL List rule: When you set on the switch, it will apply the ACL rules which are lower than some specific packet filtering rules (e.g. MAC filtering, IP-MAC-Port Binding).

Function name:

High-ACL List / Low-ACL List

Function description:

The switch ACL function support **up to 128 High Access Control List (High-ACL) and 256 Low Access Control List (Low-ACL List)**, using the shared 128 High ACEs and 256 Low ACEs for ingress classification. You can create an ACE and assign this ACE for each port with <Any> or assign this ACE for a policy or assign this ACE for a port. There are 7 priorities, each port can select one of policy, then decides which of the following actions would take according to the packet's IPv4, EtherType, ARP Protocol, MAC Parameters and VLAN parameters:



Fig. 3-72

Parameter description:

Add

To add new access control rule on switch. You must configure the parameters what described later when you add the new access control rule.

Edit/ Show:

To modify or monitor the access control configuration rule on switch.

Delete:

To delete existed access control rule on switch.

ACL Configuration

ACL Name	<input type="text"/>
Ingress Port Map	1 <input type="checkbox"/> 2 <input type="checkbox"/> 3 <input type="checkbox"/> 4 <input type="checkbox"/> 5 <input type="checkbox"/> 6 <input type="checkbox"/> 7 <input type="checkbox"/> 8 <input type="checkbox"/> 9 <input type="checkbox"/> 10 <input type="checkbox"/> 11 <input type="checkbox"/> 12 <input type="checkbox"/> 13 <input type="checkbox"/> 14 <input type="checkbox"/> 15 <input type="checkbox"/> 16 <input type="checkbox"/> 17 <input type="checkbox"/> 18 <input type="checkbox"/> 19 <input type="checkbox"/> 20 <input type="checkbox"/> 21 <input type="checkbox"/> 22 <input type="checkbox"/> 23 <input type="checkbox"/> 24 <input type="checkbox"/> 25 <input type="checkbox"/> 26 <input type="checkbox"/> All <input type="checkbox"/>
MAC DA/SA	
VLAN Tag	
Ethernet Type	
IPv4	

Fig. 3-73

ACL Configuration:

To add a new ACL rule on switch.

ACL name:

To add a new ACL rule name, A name is composed of any letter (A-Z, a-z) and digit (0-9) with maximal 8 characters.

Ingress Port Map:

To evoke the ingress ports to join the access control rule. port number is 1~26 or all.

MAC DA/SA:

To input the source and destination MAC filter.

For example: 00-40-c7-00-00-01

ACL Configuration

ACL Name	<input type="text"/>
Ingress Port Map	<input checked="" type="checkbox"/> 1 <input type="checkbox"/> 2 <input type="checkbox"/> 3 <input type="checkbox"/> 4 <input type="checkbox"/> 5 <input type="checkbox"/> 6 <input type="checkbox"/> 7 <input type="checkbox"/> 8 <input type="checkbox"/> 9 <input type="checkbox"/> 10 <input type="checkbox"/> 11 <input type="checkbox"/> 12 <input type="checkbox"/> 13 <input type="checkbox"/> 14 <input type="checkbox"/> 15 <input type="checkbox"/> 16 <input type="checkbox"/> 17 <input type="checkbox"/> 18 <input type="checkbox"/> 19 <input type="checkbox"/> 20 <input type="checkbox"/> 21 <input type="checkbox"/> 22 <input type="checkbox"/> 23 <input type="checkbox"/> 24 <input type="checkbox"/> 25 <input type="checkbox"/> 26 <input type="checkbox"/> All
MAC DA/SA	
SMAC Filter	<input type="text"/> 00 - <input type="text"/> 00 - <input type="text"/> 00 - <input type="text"/> 00 - <input type="text"/> 00
DMAC Filter	<input type="text"/> 00 - <input type="text"/> 00 - <input type="text"/> 00 - <input type="text"/> 00 - <input type="text"/> 00
VLAN Tag	
Ethernet Type	
IPv4	

Fig. 3-74

VLAN Tag:

To input VLAN Type with 2 type include “any” and “ Tag-based Vlan” If you choice Tag-based Vlan type then you must input Tag VID in field and droll the Tag Priority bar to choice the tag priority from 0 to 7.

ACL Configuration

ACL Name	<input type="text" value="rule1"/>
Ingress Port Map	<input type="checkbox"/> 1 <input type="checkbox"/> 2 <input type="checkbox"/> 3 <input type="checkbox"/> 4 <input type="checkbox"/> 5 <input type="checkbox"/> 6 <input type="checkbox"/> 7 <input type="checkbox"/> 8 <input type="checkbox"/> 9 <input type="checkbox"/> 10 <input type="checkbox"/> 11 <input type="checkbox"/> 12 <input type="checkbox"/> 13 <input type="checkbox"/> 14 <input type="checkbox"/> 15 <input type="checkbox"/> 16 <input checked="" type="checkbox"/> 17 <input checked="" type="checkbox"/> 18 <input checked="" type="checkbox"/> 19 <input checked="" type="checkbox"/> 20 <input checked="" type="checkbox"/> 21 <input type="checkbox"/> 22 <input type="checkbox"/> 23 <input type="checkbox"/> 24 <input type="checkbox"/> 25 <input type="checkbox"/> 26 <input type="checkbox"/> All
MAC DA/SA	
VLAN Tag	
Vlan Type	<input type="text" value="Tag-based Vlan"/>
Tag VID	<input type="text" value="1"/>
Tag Priority	<input type="text" value="0"/>
Ethernet Type	
IPv4	
Action	

Fig. 3-75

Ethernet Type:

ACL Configuration

ACL Name	<input type="text" value="rule1"/>
Ingress Port Map	<input type="checkbox"/> 1 <input type="checkbox"/> 2 <input type="checkbox"/> 3 <input type="checkbox"/> 4 <input type="checkbox"/> 5 <input type="checkbox"/> 6 <input type="checkbox"/> 7 <input type="checkbox"/> 8 <input type="checkbox"/> 9 <input type="checkbox"/> 10 <input type="checkbox"/> 11 <input type="checkbox"/> 12 <input type="checkbox"/> 13 <input type="checkbox"/> 14 <input type="checkbox"/> 15 <input type="checkbox"/> 16 <input checked="" type="checkbox"/> 17 <input checked="" type="checkbox"/> 18 <input checked="" type="checkbox"/> 19 <input checked="" type="checkbox"/> 20 <input checked="" type="checkbox"/> 21 <input type="checkbox"/> 22 <input type="checkbox"/> 23 <input type="checkbox"/> 24 <input type="checkbox"/> 25 <input type="checkbox"/> 26 <input type="checkbox"/> All
MAC DA/SA	
VLAN Tag	
Ethernet Type	
Frame Type	<input type="text" value="Any"/>
IPv4	
Action	

Fig. 3-76

To droll “Ethernet Type” bar and option “any”, “ IPv4”, “ ARP” and “ Specific” for ACL requirement.

- Any: It is including all frame type
- IPv4: It is including all IPv4 protocol frame type
- ARP: It is including all ARP protocol frame type
- Specific: It is specific frame type

ACL Configuration

ACL Name	rule1
Ingress Port Map	<input type="checkbox"/> 1 <input type="checkbox"/> 2 <input type="checkbox"/> 3 <input type="checkbox"/> 4 <input type="checkbox"/> 5 <input type="checkbox"/> 6 <input type="checkbox"/> 7 <input type="checkbox"/> 8 <input type="checkbox"/> 9 <input type="checkbox"/> 10 <input type="checkbox"/> 11 <input type="checkbox"/> 12 <input type="checkbox"/> 13 <input type="checkbox"/> 14 <input type="checkbox"/> 15 <input type="checkbox"/> 16 <input checked="" type="checkbox"/> 17 <input type="checkbox"/> 18 <input type="checkbox"/> 19 <input checked="" type="checkbox"/> 20 <input checked="" type="checkbox"/> 21 <input type="checkbox"/> 22 <input type="checkbox"/> 23 <input type="checkbox"/> 24 <input type="checkbox"/> 25 <input type="checkbox"/> 26 <input type="checkbox"/> All
MAC DA/SA	
VLAN Tag	
Ethernet Type	
Frame Type	Specific
Type Value	0x0000
IPv4	

Fig. 3-77

IPv4:

To set the IPv4 packet filter function with ACLs, the parameters shown as below:

Protocol : To droll the bar and you can elect “ Any”, “ICMP”, “ UDP”, “TCP” and “Other”

ACL Configuration

ACL Name	rule1
Ingress Port Map	<input type="checkbox"/> 1 <input type="checkbox"/> 2 <input type="checkbox"/> 3 <input type="checkbox"/> 4 <input type="checkbox"/> 5 <input type="checkbox"/> 6 <input type="checkbox"/> 7 <input type="checkbox"/> 8 <input type="checkbox"/> 9 <input type="checkbox"/> 10 <input type="checkbox"/> 11 <input type="checkbox"/> 12 <input type="checkbox"/> 13 <input type="checkbox"/> 14 <input type="checkbox"/> 15 <input type="checkbox"/> 16 <input checked="" type="checkbox"/> 17 <input type="checkbox"/> 18 <input type="checkbox"/> 19 <input checked="" type="checkbox"/> 20 <input checked="" type="checkbox"/> 21 <input type="checkbox"/> 22 <input type="checkbox"/> 23 <input type="checkbox"/> 24 <input type="checkbox"/> 25 <input type="checkbox"/> 26 <input type="checkbox"/> All
MAC DA/SA	
VLAN Tag	
Ethernet Type	
IPv4	
Protocol	Any
IPv4 TOS	Any
TTL Range	
IPv4 DA	
IPv4 SA	Any
L4 Destination port	Specific
Destination Port Value	0

Fig. 3-78

IPv4 TOS : To droll the bar and you can elect “ Any”, and “ Specific”. If you click “ Specific” then you need to set the TOS Value to filter.

MAC DA/SA	
VLAN Tag	
Ethernet Type	
IPv4	
Protocol	Any
IPv4 TOS	Any
TTL Range	Any
IPv4 DA	Any
IPv4 SA	Any
L4 Destination port	Any
L4 Source port	Any

Fig. 3-79

IPv4	
Protocol	Any
IPv4 TOS	Specific
TOS Value	0x 00
TTL Range	TTL=0
IPv4 DA	Any
IPv4 SA	Any
L4 Destination port	Any
L4 Source port	Any

Fig. 3-80

TTL Range : To droll the bar and you can elect “ TTL=0”, “TTL=1”, “TTL=2-254” and “ TTL=255” and set the Time to live value range.

MAC DA/SA	
VLAN Tag	
Ethernet Type	
IPv4	
Protocol	Any
IPv4 TOS	Any
TTL Range	TTL=0
IPv4 DA	Any
IPv4 SA	Any
L4 Destination port	Any
L4 Source port	Any

Fig. 3-81

IPv4 DA/ SA : To roll the bar and you can elect “ Any”, “HOST” and “Network”.

17 <input type="checkbox"/> 18 <input type="checkbox"/> 19 <input type="checkbox"/> 20 <input type="checkbox"/> 21 <input type="checkbox"/> 22 <input type="checkbox"/> 23 <input type="checkbox"/> 24 <input type="checkbox"/>	
25 <input type="checkbox"/> 26 <input type="checkbox"/> All <input type="checkbox"/>	
MAC DA/SA	
VLAN Tag	
Ethernet Type	
IPv4	
Protocol	Any <input type="button" value="v"/>
IPv4 TOS	Any <input type="button" value="v"/>
TTL Range	TTL=0 <input type="button" value="v"/>
IPv4 DA	Any <input type="button" value="v"/>
IPv4 SA	Any <input type="button" value="v"/>
L4 Destination port	Any <input type="button" value="v"/>
L4 Source port	Any <input type="button" value="v"/>

Fig. 3-82

L4 Destination port : To roll the bar and you can elect “ Any” and “Specific”. If you click “specific” then you need to set destination port value.

17 <input type="checkbox"/> 18 <input type="checkbox"/> 19 <input type="checkbox"/> 20 <input type="checkbox"/> 21 <input type="checkbox"/> 22 <input type="checkbox"/> 23 <input type="checkbox"/> 24 <input type="checkbox"/>	
25 <input type="checkbox"/> 26 <input type="checkbox"/> All <input type="checkbox"/>	
MAC DA/SA	
VLAN Tag	
Ethernet Type	
IPv4	
Protocol	Any <input type="button" value="v"/>
IPv4 TOS	Any <input type="button" value="v"/>
TTL Range	TTL=0 <input type="button" value="v"/>
IPv4 DA	Any <input type="button" value="v"/>
IPv4 SA	Any <input type="button" value="v"/>
L4 Destination port	Any <input type="button" value="v"/>
L4 Source port	Any <input type="button" value="v"/>

Fig. 3-83

17 <input type="checkbox"/> 18 <input type="checkbox"/> 19 <input type="checkbox"/> 20 <input type="checkbox"/> 21 <input type="checkbox"/> 22 <input type="checkbox"/> 23 <input type="checkbox"/> 24 <input type="checkbox"/>	
25 <input type="checkbox"/> 26 <input type="checkbox"/> All <input type="checkbox"/>	
MAC DA/SA	
VLAN Tag	
Ethernet Type	
IPv4	
Protocol	Any <input type="button" value="v"/>
IPv4 TOS	Any <input type="button" value="v"/>
TTL Range	TTL=0 <input type="button" value="v"/>
IPv4 DA	Any <input type="button" value="v"/>
IPv4 SA	Any <input type="button" value="v"/>
L4 Destination port	Specific <input type="button" value="v"/>
Destination Port Value	0 <input type="text"/>
L4 Source port	Any <input type="button" value="v"/>

Fig. 3-84

L4 Source port : To roll the bar and you can elect “ Any” and “Specific”. If you click “specific” then you need to set source port value.

The screenshot shows a configuration window with several sections: MAC DA/SA, VLAN Tag, Ethernet Type, and IPv4. Under the IPv4 section, there are several fields with dropdown menus: Protocol (Any), IPv4 TOS (Any), TTL Range (TTL=0), IPv4 DA (Any), IPv4 SA (Any), L4 Destination port (Any), and L4 Source port (Any). The L4 Source port dropdown menu is open, showing two options: "Any" and "Specific".

Fig. 3-85

The screenshot shows the same configuration window as Fig. 3-85. In this view, the L4 Source port dropdown menu is set to "Specific", and a new field labeled "Source Port Value" has appeared below it, containing the number "0".

Fig. 3-86

Action:

To set network packet filter includes “In-band” , “Out-band” and “Modify Packet for In/Out-Band”.

In-Band / Out-Band:

Forward Decision:

To roll down the bar to elect “No change” , “ Use new forward map” , “ ORed with new map” and “ Explicit actions”

Use new forward map: When the packet is in-band then it will forward to new map.

ORed with new map: When the packet is in-band then it will redirect forward to new map.

Explicit actions: When the packet is in-band then it forward with explicit action and You need to elect the parameters.

Action

In-Band	
Forward Decision	No change
Modify Packet-DSCP	No change Use new forward map ORed with new map Explicit actions
Forward Decision	No change
Modify Packet-DSCP	Any
Modify Packet for In/Out-Band	
Modify Packet-802.1P	Any
Modify Packet-QOS	Any

Fig. 3-87

Action

In-Band	
Forward Decision	Use new forward map
Forward Map	All Linked-Port
Modify Packet-DSCP	Specific
DSCP Value	0

Fig. 3-88

Action

In-Band	
Forward Decision	ORed with new map
Forward Map	Port 14
Modify Packet-DSCP	Specific
DSCP Value	0
Out-Band	

Fig. 3-89

Action

In-Band	
Forward Decision	Explicit actions
Forward Map	As ARL map and copy to mirror port
Modify Packet-DSCP	As ARL map As ARL map and copy to mirror port
DSCP Value	Drop Forward to mirror port
Out-Band	
Forward Decision	No change
Modify Packet-DSCP	Any
Modify Packet for In/Out-Band	
Modify Packet-802.1P	Any
Modify Packet-QOS	Any

Fig. 3-90

Modify Packet for In/ Out-Band :

Modify Packet -802.1P:

To roll down the bar to elect “Any” and “Specific”. If you click the “ Specific” then you need to set 802.1p value in the field. default is 0

Modify Packet for In/Out-Band	
Modify Packet-802.1P	Specific ▾
802.1P Value	0
Modify Packet-QoS	Specific ▾
QoS Value	0

Fig. 3-91

Modify Packet -QOS:

To roll down the bar to elect “Any” and “Specific”. If you click the “ Specific” then you need to set QoS value in the field. default is 0

Modify Packet for In/Out-Band	
Modify Packet-802.1P	Specific ▾
802.1P Value	0
Modify Packet-QoS	Specific ▾
QoS Value	0

Fig. 3-92

Rate Meter:

To set rate meter function with the bandwidth parameter. The range is 64 to 1024000kbps.

Rate Meter

Bandwidth	1024000	Kbps
-----------	---------	------

Fig. 3-93

3- 24. Diagnostics

Five functions, including Diagnostics, Loopback Test, Ping Test, Auto Ping and Cable are contained in this function folder for device self-diagnostics. Each of them will be described in detail orderly in the following sections.

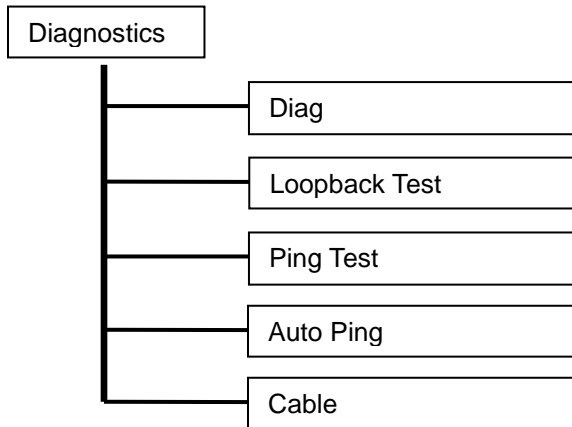

Function name:

Diag

Function description:

Diagnostics function provides a set of basic system diagnosis. It let users know that whether the system is health or needs to be fixed. The basic system check includes EEPROM test, UART test, DRAM test and Flash test.



Fig. 3-95

Function name:

Loopback Test

Function description:

In the Loopback Test function, there are two different loopback tests. One is Internal Loopback Test and the other is External Loopback Test. The former test function will not send the test signal outside the switch box. The test signal only wraps around in the switch box. As to the latter test function, it will send the test signal to its link partner. If you do not have them connected to active network devices, i.e. the ports are link down, the switch will report the port numbers failed. If they all are ok, it just shows OK.

Note: Whatever you choose Internal Loopback Test or External Loopback Test, these two functions will interfere with the normal system working, and all packets in sending and receiving also will stop temporarily.

Loopback Test

Port No	Internal Loopback	External Loopback
1	OK	OK
2	OK	Fail
3	OK	Fail
4	OK	Fail
5	OK	Fail
6	OK	Fail
7	OK	Fail
8	OK	Fail

Fig. 3-96

Function name:

Ping Test

Function description:

Ping Test function is a tool for detecting if the target device is alive or not through ICMP protocol which abounds with report messages. The switch provides Ping Test function to let you know that if the target device is available or not. You can simply fill in a known IP address and then click **<Ping>** button. After a few seconds later, the switch will report you the pinged device is alive or dead in the field of Ping Result.

Ping Test

IP Address	<input type="text"/>
Default Gateway	192.168.2.254
Ping Result	

Input an address to ping, ex. 192.168.1.1

Fig. 3-97

Parameter description:

IP Address:

An IP address with the version of v4, e.g. 192.168.1.1.

Default Gateway:

IP address of the default gateway.

For more details, please see the section of IP address in Chapter 2.

Function name:

Auto Ping

Function description:

Auto Ping function is a tool for detecting if the target device is alive or not through ICMP protocol which abounds with report messages. The switch provides auto Ping Test function to let you know that if the target device is available or not.

Auto Ping

State	IP address	Interval	Times
Disable ▾	<input type="text"/>	20 (1~300 sec)	10 (3~100)

Fig. 3-98

Parameter description:

IP Address:

An IP address with the version of v4, e.g. 192.168.1.1.

Interval:

Range is 1 ~300 sec.

Times:

Range is 3 ~100

Function name:

Cable

Function description:

Cable function is a tool for detecting if the cable per port status is OK or not. report messages. The switch provides cable Test function to let you know that if the cable connect to a port is OK or not.

Cable Diagnostic

Port to diagnose:

Status	Ok (2 pairs, deviation in 10 meters)
PAIR A	Ok, length 8 meters
PAIR B	Ok, length 8 meters

Fig. 3-99

3- 25. TFTP Server

Function name:

TFTP Server

Function description:

Set up IP address of TFTP server.



Fig. 3-100

Parameter description:

Specify the IP address where the TFTP server locates. Fill in the IP address of your TFTP server, then press **<Apply>** button to have the setting taken effect.

3-26. Log

This function shows the log data. The switch provides system log data for users. There are 16 private trap logs, 5 public trap logs. The switch supports total 120 log entries. For more details on log items, please refer to the section of Trap/Alarm Configuration and SNMP Configuration.

Function name:

Log Data

Function description:

The Trap Log Data is displaying the log items including all SNMP Private Trap events, SNMP Public traps and user logs occurred in the system. In the report table, No., Time and Events are three fields contained in each trap record.

Log Data		
TFTP Server	0.0.0.0	
Auto Upload	Disabled	
No.	Time	Events
1	Mon Feb 16 14:04:16 2009	Login [admin]
2	Mon Feb 16 13:04:40 2009	LACP Enabled [Port 26 : Group: 1]
3	Mon Feb 16 13:04:40 2009	LACP Enabled [Port 25 : Group: 1]
4	Mon Feb 16 12:36:22 2009	Login [admin]
5	Mon Feb 16 09:58:35 2009	Login [admin]
6	Mon Feb 16 09:46:30 2009	Tag-based VLAN Enabled
7	Mon Feb 16 09:38:26 2009	Port-based VLAN Enabled
8	Mon Feb 16 08:46:26 2009	Logout [admin]
9	Mon Feb 16 08:40:53 2009	Login [admin]
10	Mon Feb 16 08:29:41 2009	Login [admin]
11	Mon Feb 16 08:02:35 2009	Cold Start

Auto Upload Enable	Upload Log	Clear Log
--------------------	------------	-----------

Fig. 3-101

Parameter description:

No.:

Display the order number that the trap happened.

Time:

Display the time that the trap happened.

Events:

Display the trap event name.

Auto Upload Enable:

Switch the enabled or disabled status of the auto upload function.

Upload Log:

Upload log data through tftp.

Clear Log:

Clear log data.

3-27. Firmware Upgrade

Software upgrade tool is used to help upgrade the software function in order to fix or improve the function. The switch provides a TFTP client for software upgrade. This can be done through Ethernet.

Function name:

Firmware Upgrade

Function description:

The switch supports TFTP upgrade tool for upgrading software. If you assure to upgrade software to a newer version one, you must follow two procedures:

- 1.) Specifying the IP address where TFTP server locates. In this field, the IP address of your TFTP server should be filled in.
- 2.) Specifying what the filename and where the file is. You must specify full path and filename.

Then, press **<Upgrade>** button if your download is not successful, the switch will also be back to “Software Upgrade”, and it will not upgrade the software as well.

When download is completed, the switch starts upgrading software. A reboot message will be prompted after completing upgrading software. At this time, you must reboot the switch to have new software worked.

Note: Software upgrade is hazardous if power is off. You must do it carefully.

Firmware Upgrade

TFTP Server	0.0.0.0
Path and Filename	

Upgrade

Fig. 3-102

Parameter description:

TFTP Server: A TFTP server stored the image file you want to upgrade.

Path and Filename: File path and filename stored the image file you want to upgrade.

3-28. Reboot

We offer you many ways to reboot the switch, including power up, hardware reset and software reset. You can press the RESET button in the front panel to reset the switch. After upgrading software, changing IP configuration or changing VLAN mode configuration, then you must reboot to have the new configuration taken effect. Here we are discussing is software reset for the “reboot” in the main menu.

Function name:

Reboot

Function description:

Reboot the switch. Reboot takes the same effect as the RESET button on the front panel of the switch. It will take around thirty (30) seconds to complete the system boot.

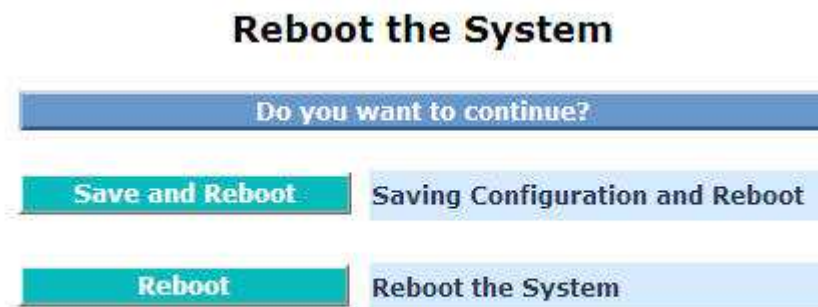

Fig. 3-103

Parameter description:

Save and Reboot:

Save the current settings as start configuration before rebooting the switch.

Reboot:

Reboot the system directly.

3-29. Logout

You can manually logout by performing Logout function. In the switch, it provides another way to logout. You can configure it to logout automatically.

Function name:

Logout

Function description:

The switch allows you to logout the system to prevent other users from the system without the permission. If you do not logout and exit the browser, the switch will automatically have you logout. Besides this manually logout and implicit logout, you can pull down the **<Auto Logout>** list at the left-top corner to explicitly ON/OFF this logout function.



Fig. 3-104

Parameter description:

Auto Logout:

Default is ON. If it is "ON", and no action and no key is stroke as well in any function screen more than 3 minutes, the switch will have you logout automatically.

4. Operation of CLI Management

4-1. CLI Management

Refer to Chapter 2 for basic installation. The following description is the brief of the network connection.

- Locate the correct DB-9 null modem cable with female DB-9 connector. Null modem cable comes with the management switch. Refer to the Appendix B for null modem cable configuration.
- Attach the DB-9 female connector to the male DB-9 serial port connector on the Management board.
- Attach the other end of the DB-9 cable to an ASCII terminal emulator or PC Com-1, 2 port. For example, PC runs Microsoft Windows HyperTerminal utility.
- At "Com Port Properties" Menu, configure the parameters as below: (see the next section)

Baud rate	57600
Stop bits	1
Data bits	8
Parity	N
Flow control	none

4-1-1. Login

The command-line interface (CLI) is a text-based interface. User can access the CLI through either a direct serial connection to the device or a Telnet session. The default values of the managed switch are listed below:

Username: admin

Password: admin

After you login successfully, the prompt will be shown as "#" if you are the first login person and your authorization is administrator; otherwise it may show "\$". See the following two figures. The former means you behave as an administrator and have the access right of the system. As to the latter, it means you behave as a guest and are only allowed to view the system without the permission to do any setting for this switch.

```
Managed Switch - ES-2226C  
Login: admin  
Password:  
ES-2226C#
```

Fig. 4-1

4-2. Commands of CLI

To see the commands of the mode, please input “?” after the prompt, then all commands will be listed in the screen. All commands can be divided into two categories, including global commands and local commands. Global commands can be used wherever the mode you are. They are “exit”, “end”, “help”, “history”, “logout”, “save start”, “save user”, “restore default” and “restore user”. For more details, please refer to Section 4-2-1.

Command instructions reside in the corresponding modes are local commands. The same command with the same command name may occur but perform totally different function in different modes. For example, “show” in IP mode performs displaying the IP information; however, it performs displaying the system information in system mode. For more details, please refer to Section 4-2-2.

```
Login: admin
Password:

FEL2P-SW26# help
Commands available:
-----<< Local commands >>-----
802.1X      Enter into 802.1X mode
account    Enter into account mode
acl        Enter into acl mode
alarm      Enter into alarm mode
autologout Change autologout time
bandwidth  Enter into bandwidth mode
config-file Enter into config file mode
dhcp-boot  Enter into dhcp-boot mode
dhcp-snooping Enter into DHCP snooping mode
diag       Enter into diag mode
firmware   Enter into firmware mode
gvrp       Enter into gvrp mode
hostname   Change hostname
ip         Enter into ip mode
ip-mac-bind Enter into IP-MAC binding mode
log        Enter into log mode
loop-detection Enter into Loop-Detection(LD) mode
mac-table  Enter into mac table mode
management Enter into management mode
mstp       Enter into mstp mode
```

Fig. 4-2

4-2-1. Global Commands of CLI

end

Syntax:

end

Description:

Back to the top mode.

When you enter this command, your current position would move to the top mode. If you use this command in the top mode, you are still in the position of the top mode.

Argument:

None.

Possible value:

None.

Example:

```
FEL2P-SW26 # alarm
FEL2P-SW26 (alarm)# events
FEL2P-SW26 (alarm-events)# end
```

```
FEL2P-SW26 #
```

exit

Syntax:

exit

Description:

Back to the previous mode.

When you enter this command, your current position would move back to the previous mode. If you use this command in the top mode, you are still in the position of the top mode.

Argument:

None.

Possible value:

None.

Example:

```
FEL2P-SW26 # trunk
FEL2P-SW26 (trunk)# exit
```

```
FEL2P-SW26 #
```

help

Syntax:

help

Description:

To show available commands.

Some commands are the combination of more than two words. When you enter this command, the CLI would show the complete commands. Besides, the command would help you classify the commands between the local commands and the global ones.

Argument:

None.

Possible value:

None.

Example:

```
FEL2P-SW26# ip
```

```
FEL2P-SW26(ip)# help
```

```
Commands available:
```

```
-----<< Local commands >>-----
disable dhcp      Disable DHCP
enable dhcp       Enable DHCP, and set dns auto or manual
set dns           Set dns
set ip            Set ip and gateway
show              Show IP Configuration
-----<< Global commands >>-----
end               Back to the top mode
exit              Back to the previous mode
help              Show available commands
history           Show a list of previously run commands
logout            Logout the system
restore default   Restore default config
restore user      Restore user config
save start        Save as start config
save user         Save as user config
```

```
FEL2P-SW26(ip)#
```

history

Syntax:

history [#]

Description:

To show a list of previous commands that you had ever run.

When you enter this command, the CLI would show a list of commands which you had typed before. The CLI supports up to 256 records. If no argument is typed, the CLI would list total records up to 256. If optional argument is given, the CLI would only show the last numbers of records, given by the argument.

Argument:

[#]: show last number of history records. (optional)

Possible value:

[#]: 1, 2, 3,, 256

Example:

```
FEL2P-SW26 (ip)# history
```

```
Command history:
```

0. ?
1. trunk
2. exit
3. FEL2P-SW26 # trunk
4. FEL2P-SW26 (trunk)# exit
5. FEL2P-SW26 #
6. trunk
7. exit
8. alarm
9. events
10. end
11. ip
12. help
13. history

```
FEL2P-SW26 (ip)# history 3
```

```
Command history:
```

12. help
13. history
14. history 3

```
FEL2P-SW26 (ip)#
```

logout

Syntax:

logout

Description:

When you enter this command via Telnet connection, you would logout the system and disconnect. If you connect the system through direct serial port with RS-232 cable, you would logout the system and be back to the initial login prompt when you run this command.

Argument:

None.

Possible value:

None.

Example:

```
FEL2P-SW26# logout
```

Managed Switch - FEL2P-SW26

Login:

restore default

Syntax:

restore default

Description:

When you use this function in CLI, the system will show you the information “Do you want to restore the default IP address?(y/n)”. If you choose Y or y, the IP address will restore to default “192.168.1.1”. If you choose N or n, the IP address will keep the same one that you had saved before.

If restoring default successfully, the CLI would prompt if reboot immediately or not. If you press Y or y, the system would reboot immediately; otherwise, it would be back to the CLI system. After restoring default configuration, all the changes in the startup configuration would be lost. After rebooting, the entire startup configuration would reset to factory default.

Argument:

None.

Possible value:

None.

Example:

```
FEL2P-SW26# restore default
Do you want to restore the default ip address?(y/n)
Restoring ...
Restore default configuration successfully.
Do you want to reboot the system?(y/n)
```

restore user

Syntax:

restore user

Description:

To restore the startup configuration as user defined configuration. If restoring default successfully, the CLI would prompt if reboot immediately or not. If you press Y or y, the system would reboot immediately; others would back to the CLI system. After restoring user-defined configuration, all the changes in the startup configuration would be lost. After rebooting, the entire startup configuration would replace as user defined one.

Argument:

None.

Possible value:

None.

Example:

```
FEL2P-SW26# restore user
Restoring ...
Restore user configuration successfully.
Do you want to reboot the system?(y/n)
```

save start

Syntax:

save start

Description:

To save the current configuration as the start one. When you enter this command, the CLI would save your current configuration into the non-volatile FLASH. If you want the configuration still works after rebooting, save the configuration using the command 'save stat'.

Argument:

None.

Possible value:

None.

Example:

```
FEL2P-SW26 # save start
Saving start...
Save Successfully
```

```
FEL2P-SW26 #
```

save user

Syntax:

save user

Description:

To save the current configuration as the user-defined configuration. When you enter this command, the CLI would save your current configuration into the non-volatile FLASH as user-defined configuration.

Argument:

None.

Possible value:

None.

Example:

```
FEL2P-SW26 # save user
```

```
Saving user...
```

```
Save Successfully
```

```
FEL2P-SW26 #
```

4-2-2. Local Commands of CLI

■ 802.1x

set quiet-period

Syntax:

set quiet-period <port-range> <sec>

Description:

A timer used by the Authenticator state machine to define periods of time during when it will not attempt to acquire a Supplicant.

Argument:

<port range> : syntax 1,5-7, available from 1 to 26

<sec> : timer, range 0-65535

Possible value:

<port range> : 1 to 26

<sec> : 0-65535, default is 60

Example:

```
FEL2P-SW26 (802.1x)# set quiet-period 2 30
```

set reAuthEnabled

Syntax:

set reAuthEnabled <port-range> <ebl>

Description:

A constant that define whether regular reauthentication will take place on this port.

Argument:

<port range> : syntax 1,5-7, available from 1 to 26

<ebl> :

0:"OFF" to disable reauthentication

1:"ON" to enable reauthentication

Possible value:

<port range> : 1 to 26

<ebl> : 0 or 1, default is 1

Example:

```
FEL2P-SW26 (802.1x)# set reAuthEnabled 2 1
```

set reAuthMax

Syntax:

set reAuthMax <port-range> <max>

Description:

The number of reauthentication attempts that are permitted before the port becomes Unauthorized.

Argument:

<port range> : syntax 1,5-7, available from 1 to 26

<max> : max. value , range 1-10

Possible value:

<port range> : 1 to 26
<max> : 1-10, default is 2

Example:

```
FEL2P-SW26 (802.1x)# set reAuthMax 2 2
```

set reAuthPeriod

Syntax:

```
set reAuthPeriod <port-range> <sec>
```

Description:

A constant that defines a nonzero number of seconds between periodic reauthentication of the supplicant.

Argument:

<port range> : syntax 1,5-7, available from 1 to 26

<sec> : timer, range 1-65535

Possible value:

<port range> : 1 to 26

<sec> : 1-65535, default is 3600

Example:

```
FEL2P-SW26 (802.1x)# set reAuthPeriod 2 3600
```

set serverTimeout

Syntax:

```
set serverTimeout <port-range> <sec>
```

Description:

A timer used by the Backend Authentication state machine in order to determine timeout conditions in the exchanges between the Authenticator and the Supplicant or Authentication Server. The initial value of this timer is either suppTimeout or serverTimeout, as determined by the operation of the Backend Authentication state machine.

Argument:

<port range> : syntax 1,5-7, available from 1 to 26

<sec> : timer, range 1-65535

Possible value:

<port range> : 1 to 26

<sec> : 1-65535, default is 30

Example:

```
FEL2P-SW26 (802.1x)# set serverTimeout 2 30
```

set state

Syntax:

```
set state <ip> <port-number> <secret-key> <Accounting Service> <Accounting Server> <Accounting Port>
```

Description:

To configure the settings related with 802.1X Radius Server.

Argument:

<ip> : the IP address of Radius Server, and the IP format is xxx.xxx.xxx.xxx

<port-number> : the service port of Radius Server(Authorization port),
range 1~65535

<secret-key> : set up the value of secret-key, and the length of secret-key is

from 1 to 31
<Accounting Service> : 0 for disable, 1 for enable
<Accounting Server> : xxx.xxx.xxx.xxx
<Accounting Port> :1~65535

Possible value:

<port-number> : 1~65535, default 1812
<Accounting Service> : 0 for disable, 1 for enable
<Accounting Server> : xxx.xxx.xxx.xxx
<Accounting Port> :1~65535

Example:

```
FEL2P-SW26(802.1X)# set state 192.168.2.252 1812 winradius 1 192.168.2.252 225
```

```
FEL2P-SW26(802.1X)# show state
Radius Server      : 192.168.2.252
Port Number       : 1812
Secret Key        : winradius
Accounting Service : Enable
Accounting Server : 192.168.2.252
Accounting Port   : 225
```

```
FEL2P-SW26(802.1X)#
```

set suppTimeout

Syntax:

```
set suppTimeout <port-range> <sec>
```

Description:

A timer used by the Backend Authentication state machine in order to determine timeout conditions in the exchanges between the Authenticator and the Supplicant or Authentication Server. The initial value of this timer is either suppTimeout or serverTimeout, as determined by the operation of the Backend Authentication state machine.

Argument:

<port range> : syntax 1,5-7, available from 1 to 26
<sec> : timer, range 1-65535

Possible value:

<port range> : 1 to 26
<sec> : 1-65535, default is 30

Example:

```
MSM-6226 (802.1x)# set suppTimeout 2 30
```

set txPeriod

Syntax:

```
set txPeriod <port-range> <sec>
```

Description:

A timer used by the Authenticator PAE state machine to determine when an EAPOL PDU is to be transmitted.

Argument:

<port range> : syntax 1,5-7, available from 1 to 26

<sec> : timer, range 1-65535

Possible value:

<port range> : 1 to 26

<sec> : 1-65535, default is 30

Example:

```
FEL2P-SW26 (802.1x)# set txPeriod 2 30
```

show mode**Syntax:**

```
show mode
```

Description:

To display the mode of each port.

Argument:

None.

Possible value:

None.

Example:

```
FEL2P-SW26 (802.1X)# show mode
```

```

=====
1      Disable
2      Disable
3      Disable
4      Disable
5      Disable
6      Disable
7      Disable
8      Disable
9      Disable
10     Advanced 802.1X
11     Disable
12     Disable
13     Disable
14     Disable
15     Disable
16     Disable
      :
      :

```

Show parameter**Syntax:**

```
show parameter
```

Description:

To display the parameter settings of each port.

Argument:

None.

Possible value:

None.

Example:

```
FEL2P-SW26 (802.1x)# show parameter
```

```

port 1) port control : Auto
      reAuthMax      : 2
      txPeriod       : 30
      Quiet Period   : 60
      reAuthEnabled  : ON
      reAuthPeriod   : 3600
      max. Request   : 2
      suppTimeout    : 30
      serverTimeout  : 30
      :
      :
      :

```

show security

Syntax:

```
show security
```

Description:

To display the authentication status of each port.

Argument:

None.

Possible value:

None.

Example:

```
MSM-6226FEL2P-SW26 (802.1x)# show security
```

```

Port      Mode      Status
=====
 1      Disable
 2      Disable
 3      Disable
 4      Disable
 5      Disable
 6      Normal   Unauthorized
 7      Disable
 8      Disable
 9      Disable
10      Authorized Entries :0
11      Disable
12      Disable

```

show state

Syntax:

show state

Description:

To display the Radius server configuration.

Argument:

None.

Possible value:

None.

Example:

```
FEL2P-SW26 (802.1x)# show state
Radius Server: 192.168.1.115
Port Number   : 1812
Secret Key    : WinRadius
```

■ **account**

add

Syntax:

add <name>

Description:

To create a new guest user. When you create a new guest user, you must type in password and confirm password.

Argument:

<name> : new account name

Possible value:

<name> : A string must be at least 5 character.

Example:

```
FEL2P-SW26(account)# add aaaaa
Password:
Confirm Password:
FEL2P-SW26(account)#
```

del

Syntax:

del <name>

Description:

To delete an existing account.

Argument:

<name> : existing user account

Possible value:

None.

Example:

```
FEL2P-SW26(account)# del aaaaa
Account aaaaa deleted
```

modify

Syntax:

modify <name>

Description:

To change the username and password of an existing account.

Argument:

<name> : existing user account

Possible value:

None.

Example:

```
FEL2P-SW26(account)# modify aaaaa
username/password: the length is from 5 to 15.
Current username (aaaaa):bbbb
New password:
Confirm password:
Username changed successfully.
Password changed successfully.
```

show**Syntax:**

show

Description:

To show system account, including account name and identity.

Argument:

None.

Possible value:

None.

Example:

```
FEL2P-SW26(account)# show
```

Account Name	Identity
admin	Administrator
guest	guest
bbbb	guest

■ alarm

<<email>>

del mail-address

Syntax:

del mail-address <#>

Description:

To remove the e-mail address.

Argument:

<#>: email address number, range: 1 to 6

Possible value:

<#>: 1 to 6

Example:

```
FEL2P-SW26(alarm-email)# del mail-address 2
```

del server-user

Syntax:

del server-user

Description:

To remove the server, user account and password.

Argument:

None.

Possible value:

None.

Example:

```
FEL2P-SW26(alarm-email)# del server-user
```

set mail-address

Syntax:

set mail-address <#> <mail address>

Description:

To set up the email address.

Argument:

<#> : email address number, range: 1 to 6

<mail address> : email address

Possible value:

<#>: 1 to 6

Example:

```
FEL2P-SW26(alarm-email)# set mail-address 1 abc@mail.abc.com
```

set server

Syntax:

set server <ip>

Description:

To set up the IP address of the email server.

Argument:

<ip>:email server ip address or domain name

Possible value:

None.

Example:

```
FEL2P-SW26(alarm-email)# set server 192.168.1.6
```

set user

Syntax:

set user <username>

Description:

To set up the account of the email server.

Argument:

<username>: email server account

Possible value:

None.

Example:

```
FEL2P-SW26(alarm-email)# set user admin
```

show

Syntax:

show

Description:

To display the configuration of e-mail trap event.

Argument:

None.

Possible value:

None.

Example:

```
FEL2P-SW26(alarm-email)# show
Mail Server      : 192.168.1.6
Username         : admin
Password         : *****
Email Address 1 : abc@mail.abc.com
Email Address 2 :
Email Address 3 :
Email Address 4 :
Email Address 5 :
Email Address 6 :
```

<<events>>

del all

Syntax:

del all <range>

Description:

To disable email and trap of events.

Argument:

<range>:del the range of email and trap of events, syntax 1,5-7, available from 1 to 25

Possible value:

<range>: 1~25

Example:

```
FEL2P-SW26(alarm-events)# del all 1-3
```

del email

Syntax:

del email <range>

Description:

To disable the email of the events.

Argument:

<range>:del the range of email, syntax 1,5-7, available from 1 to 25

Possible value:

<range>: 1~25

Example:

```
FEL2P-SW26(alarm-events)# del email 1-3
```

del trap

Syntax:

del trap <range>

Description:

To disable the trap of the events.

Argument:

<range>:del the range of trap, syntax 1,5-7, available from 1 to 25

Possible value:

<range>: 1~25

Example:

```
FEL2P-SW26(alarm-events)# del trap 1-3
```

set all

Syntax:

set all <range>

Description:

To enable email and trap of events.

Argument:

<range>:set the range of email and trap of events, syntax 1,5-7, available from 1 to 25

Possible value:

<range>: 1~25

Example:

```
FEL2P-SW26(alarm-events)# set all 1-3
```

set email

Syntax:

set email <range>

Description:

To enable the email of the events.

Argument:

<range>:set the range of email, syntax 1,5-7, available from 1 to 25

Possible value:

<range>: 1~25

Example:

```
FEL2P-SW26(alarm-events)# set email 1-3
```

set trap

Syntax:

set trap <range>

Description:

To enable the trap of the events.

Argument:

<range>:set the range of trap, syntax 1,5-7, available from 1 to 25

Possible value:

<range>: 1~25

Example:

```
FEL2P-SW26(alarm-events)# set trap 1-3
```

show

Syntax:

show

Description:

The Show here is used to display the configuration of alarm event.

Argument:

None.

Possible value:

None.

Example:

```
FEL2P-SW26(alarm-events)# show
  Events                Email    Trap
-----
1  Cold Start                v
2  Warm Start                v
3  Link Down                 v
4  Link Up                   v
5  Authentication Failure    v
6  User Login
7  User Logout
8  STP Topology Changed
9  STP Disabled
10 STP Enabled
11 LACP Disabled
12 LACP Enabled
13 LACP Member Added
14 LACP Port Failure
15 GVRP Disabled
16 GVRP Enabled
17 Port-based Vlan Enabled
18 Tag-based Vlan Enabled
19 Metro-mode Vlan Enabled
20 Module Inserted
21 Module Removed
22 Dual Media Swapped
23 Looping Detected
24 IP-MAC Binding Offered
25 IP-MAC Binding Released    v
```

show (alarm)

Syntax:

show

Description:

The Show for alarm here is used to display the configuration of Trap or E-mail.

Argument:

None.

Possible value:

None.

Example:

```
FEL2P-SW26 (alarm)# show email
Mail Server      :
Username         :
Password        : *****
Email Address 1:
Email Address 2:
```

Email Address 3:
Email Address 4:
Email Address 5:
Email Address 6:

FEL2P-SW26 (alarm)# show events

1	Cold Start	v
4	Link Up	v
5	Authentication Failure	v
6	User Login	
7	User Logout	
8	STP Topology Changed	
9	STP Disabled	
10	STP Enabled	
11	LACP Disabled	
12	LACP Enabled	
13	LACP Member Added	
14	LACP Port Failure	
15	GVRP Disabled	
16	GVRP Enabled	
17	Port-based Vlan Enabled	
18	Tag-based Vlan Enabled	
19	Metro-mode Vlan Enabled	
20	Module Inserted	
21	Module Removed	
22	Dual Media Swapped	
23	Looping Detected	
24	IP-MAC Binding Offered	
25	IP-MAC Binding Released	v

■ autologout

autologout

Syntax:

autologout <time>

Description:

To set up the timer of autologout.

Argument:

<time>: range 1 to 3600 seconds, 0 for autologout off, current setting is 180 seconds.

Possible value:

< time >: 0,1-3600

Example:

```
FEL2P-SW26 # autologout 3600
```

Set autologout time to 3600 seconds

■ bandwidth

set egress

Syntax:

set egress <range> < rate>

Description:

To set up the egress-rate of the ports.

Argument:

<range>:syntax 1,5-7, available from 1 to 26

< rate>: 64-1024000(Kb).

port 1-24: 64-102400(Kb); port 25-26: 64-1024000(Kb)

Possible value:

<range>: 1 to 26

<rate>: 64-102400(Kb) for port 1-24; 64-1024000(Kb) for port 25-26

Example:

```
FEL2P-SW26(bandwidth)# set egress 8-12 3780
```

```
FEL2P-SW26(bandwidth)# show
```

```
Port   Ingress Rate(Kb)   Egress Rate(Kb)   Storm Type   Storm Rate(Kb)
snmp mode
      stp
```

=====

Enter into system mode

1	102400	102400	DISABLE	102400
2	102400	102400	DISABLE	102400
3	102400	102400	DISABLE	102400
4	102400	102400	DISABLE	102400
5	102400	102400	DISABLE	102400
6	102400	102400	DISABLE	102400
7	102400	102400	DISABLE	102400
8	102400	3776	DISABLE	102400
9	102400	3776	DISABLE	102400
10	102400	3776	DISABLE	102400

11	102400	3776	DISABLE	102400
12	102400	3776	DISABLE	102400
13	102400	102400	DISABLE	102400
14	102400	102400	DISABLE	102400
15	102400	102400	DISABLE	102400
16	102400	102400	DISABLE	102400
17	102400	102400	DISABLE	102400
18	102400	102400	DISABLE	102400
19	102400	102400	DISABLE	102400
20	102400	102400	DISABLE	102400
21	102400	102400	DISABLE	102400
22	102400	102400	DISABLE	102400
23	102400	102400	DISABLE	102400
24	102400	102400	DISABLE	102400
25	1024000	1024000	DISABLE	1024000
26	1024000	1024000	DISABLE	1024000

set ingress-rate

Syntax:

set ingress <range> <rate>

Description:

To set up the ingress-rate of the ports.

Argument:

<range>:syntax 1,5-7, available from 1 to 26

<rate>: 64-1024000(Kb).

port 1-24: 64-102400(Kb); port 25-26: 64-1024000(Kb)

Possible value:

<range>: 1 to 26

<rate>: 64-102400(Kb) for port 1-24; 64-1024000(Kb) for port 25-26

Example:

```
FEL2P-SW26 (bandwidth)# set ingress 1-16 100
```

```
FEL2P-SW26 (bandwidth)# show
```

```
Port    Ingress Rate(Kb)    Egress Rate(Kb)    Storm Type    Storm Rate(Kb)
```

```
snmp mode
```

```
stp
```

```
=====
```

```
Enter into system mode
```

1	102400	102400	DISABLE	102400
2	102400	102400	DISABLE	102400
3	102400	102400	DISABLE	102400
4	102400	102400	DISABLE	102400
5	102400	102400	DISABLE	102400
6	102400	102400	DISABLE	102400

```
7    102400    102400    DISABLE    102400
```

```
8    102400    3776     DISABLE    102400
```

9	102400	3776	DISABLE	102400
10	102400	3776	DISABLE	102400
11	102400	3776	DISABLE	102400
12	102400	3776	DISABLE	102400
13	102400	102400	DISABLE	102400
14	102400	102400	DISABLE	102400
15	19520	102400	DISABLE	102400
16	19520	102400	DISABLE	102400
17	19520	102400	DISABLE	102400
18	19520	102400	DISABLE	102400
19	102400	102400	DISABLE	102400
20	102400	102400	DISABLE	102400
21	102400	102400	DISABLE	102400
22	102400	102400	DISABLE	102400
23	102400	102400	DISABLE	102400
24	102400	102400	DISABLE	102400
25	1024000	1024000	DISABLE	1024000
26	1024000	1024000	DISABLE	1024000

set storm

Syntax:

set storm <range> <type> <rate>

Description:

To set up the storm control of the ports.

Argument:

<range>:syntax: 1,5-7, available from 1 to 26

<type>:

0 - Disable

1 - BC for broadcast storm

2 - UC for unicast storm

3 - BC,UC for both broadcast and unicast storm

4 - MC for multicast storm

5 - BC,MC for both broadcast and multicast storm

6 - UC,MC for both unicast and multicast storm

7 - BC,UC,MC for broadcast, unicast and multicast storm<data_rate>: 1-100.

<rate>: 64 - 1024000 (Kbps).

FE port: 64 - 102400 (Kbps)

GE port: 64 - 1024000 (Kbps).

Possible value:

<range>: 1 to 26

<type> : 0 to 7

<rate>: 64- 1024000 (Kbps)

Example:

```
FEL2P-SW26(bandwidth)# set storm 20 3 5000
```

```
FEL2P-SW26(bandwidth)# show
```

```
Port    Ingress Rate(Kb)    Egress Rate(Kb)    Storm Type    Storm Rate(Kb)
```

```
=====
...
5      102400              102400             DISABLE       102400
```

6	102400	102400	DISABLE	102400
7	102400	102400	DISABLE	102400
8	102400	3776	DISABLE	102400
9	102400	3776	DISABLE	102400
10	102400	3776	DISABLE	102400
11	102400	3776	DISABLE	102400
12	102400	3776	DISABLE	102400
13	102400	102400	DISABLE	102400
14	102400	102400	DISABLE	102400
15	19520	102400	DISABLE	102400
16	19520	102400	DISABLE	102400
17	19520	102400	DISABLE	102400
18	19520	102400	DISABLE	102400
19	102400	102400	DISABLE	102400
20	102400	102400	BC, UC	4992
21	102400	102400	DISABLE	102400
22	102400	102400	DISABLE	102400
23	102400	102400	DISABLE	102400
24	102400	102400	DISABLE	102400
25	1024000	1024000	DISABLE	1024000
26	1024000	1024000	DISABLE	1024000

FEL2P-SW26 (bandwidth) #

show

Syntax:

show

Description:

To display all current settings of the bandwidth.

Argument:

None

Possible value:

None

Example:

FEL2P-SW26 (bandwidth) # show

FEL2P-SW26 (bandwidth) # show

Port	Ingress Rate (Kb)	Egress Rate (Kb)	Storm Type	Storm Rate (Kb)
------	-------------------	------------------	------------	-----------------

=====

...				
5	102400	102400	DISABLE	102400
6	102400	102400	DISABLE	102400
7	102400	102400	DISABLE	102400
8	102400	3776	DISABLE	102400
9	102400	3776	DISABLE	102400
10	102400	3776	DISABLE	102400
11	102400	3776	DISABLE	102400

12	102400	3776	DISABLE	102400
13	102400	102400	DISABLE	102400
14	102400	102400	DISABLE	102400
15	19520	102400	DISABLE	102400
16	19520	102400	DISABLE	102400
17	19520	102400	DISABLE	102400
18	19520	102400	DISABLE	102400
19	102400	102400	DISABLE	102400
20	102400	102400	BC, UC	4992
21	102400	102400	DISABLE	102400
22	102400	102400	DISABLE	102400
23	102400	102400	DISABLE	102400
24	102400	102400	DISABLE	102400
25	1024000	1024000	DISABLE	1024000
26	1024000	1024000	DISABLE	1024000

■ config-file

export start

Syntax:

export start

Description:

To run the export start function.

Argument:

None.

Possible value:

None.

Example:

```
FEL2P-SW26 (config-file)# export start
```

Export successful.

export user-conf

Syntax:

export user-conf

Description:

To run the export user-conf function.

Argument:

None.

Possible value:

None.

Example:

```
FEL2P-SW26 (config-file)# export user-conf
```

Export successful.

import start

Syntax:

import start

Description:

To run the import start function.

Argument:

None.

Possible value:

None.

Example:

```
FEL2P-SW26 (config-file)# import start
Import successful.
```

import user-conf

Syntax:

import user-conf

Description:

To run the import user-conf function.

Argument:

None.

Possible value:

None.

Example:

```
FEL2P-SW26 (config-file)# import user-conf
Import successful.
```

set export-path

Syntax:

set export-path <filepath>

Description:

To set up the file path and filename that user would like to export.

Argument:

<filepath>:filepath and filename

Possible value:

<filepath>:filepath and filename

Example:

```
FEL2P-SW26 (config-file)# set export-path log/21511.txt
```

set import-path

Syntax:

set import-path <filepath>

Description:

To set up the filepath and filename that user would like to import.

Argument:

<filepath>:filepath and filename

Possible value:

<filepath>:filepath and filename

Example:

```
FEL2P-SW26 (config-file)# set import-path log/21511.txt
```

show

Syntax:

show

Description:

To display the information of the config file.

Argument:

None.

Possible value:

None.

Example:

```
FEL2P-SW26(config-file)# show
TFTP Server IP Address: 192.168.3.111
Export Path and Filename: log/21511.txt
Import Path and Filename: log/21511.txt
```

■ **dhcp-boot**

set

Syntax:

set <sec>

Description:

To set up the delay time for DHCP Boot.

Argument:

<sec>:range syntax: 0, 1-30. The value "0" is to disable dhcp-boot delay

Possible value:

<sec>:0-30

Example:

```
FEL2P-SW26 (dhcp-boot)# set 30
```

show

Syntax:

show

Description:

To display the status of DHCP Boot.

Argument:

None.

Possible value:

None.

Example:

```
FEL2P-SW26(dhcp-boot)# show
DHCP Boot : Enable
Second    : 30
FEL2P-SW26(dhcp-boot)#
```

■ diag**<<autoping>>*****disable*****Syntax:**

disable

Description:

Disable auto ping function on switch

Argument:

None.

Possible value:

None.

Example:

```
FEL2P-SW26 (diag-autoping)# disable
```

enable**Syntax:**

enable

Description:

Enable auto ping function on switch

Argument:

None.

Possible value:

None.

Example:

```
FEL2P-SW26 (diag-autoping)# enable
```

set

Syntax:

```
set <IP address> <interval> <times>
```

Description:

To set auto ping function on switch

Argument:

<IP address> : IPv4 format

<interval>: 1~300 (sec)

<times>: 3~100

Possible value:

<IP address> : IPv4 format

<interval>: 1~300 (sec)

<times>: 3~100

Example:

```
FEL2P-SW26(diag-autoping)# set 192.168.2.22 100 3
```

```
FEL2P-SW26(diag-autoping)# show
```

```
Auto Ping state :Enabled
```

```
IP address      :192.168.2.22
```

```
Interval(sec)   :100
```

```
Times           :3
```

```
FEL2P-SW26(diag-autoping)#
```

show**Syntax:**

```
show
```

Description:

To show auto ping function on switch

Argument:

none

Possible value:

none

Example:

```
FEL2P-SW26(diag-autoping)# show
```

```
Auto Ping state :Enabled
```

```
IP address      :192.168.2.22
```

```
Interval(sec)   :100
```

```
Times           :3
```

```
FEL2P-SW26(diag-autoping)#
```

<< cable >>***cable***

Syntax:

cable <port>

Description:

To enable cable diagnostic function on switch

Argument:

<port> : syntax: 1,5-7, available from 1 to 26

Possible value:

<port> : 1 to 26.

Example:

```
FEL2P-SW26(diag)# cable 1-5
port 1: cable Ok (2 pairs, length +/- 10 meters)
        pair A Ok, length 10 meters
        pair B Ok, length 10 meters
```

diag**Syntax:**

diag

Description:

Diag is used to test whether EEPROM, UART, DRAM and Flash is normal or not.

Argument:

None.

Possible value:

None.

Example:

```
FEL2P-SW26 (diag)# diag
EEPROM Test : OK
UART Test   : OK
DRAM Test   : OK
Flash Test  : OK
```

Loopback**Syntax:**

loopback

Description:

For Internal/External Loopback Test.

Argument:

None.

Possible value:

None.

Example:

```
FEL2P-SW26(diag)# loopback
Internal Loopback Test : OK
```

```
External Loopback Test : Port 2 3 4 6 8 9 10 11 12 13 14 15 16 17 18 19 20
21 22 23 24 25 26 Fail
```

```
FEL2P-SW26(diag)#
```

ping

Syntax:

```
ping <ip>
```

Description:

To confirm that whether the remote end-station or switch itself is alive or not.

Argument:

<ip> : IP address or domain name

Possible value:

IP address, e.g. 192.168.2.65 or domain name, e.g. tw.yahoo.com

Example:

```
FEL2P-SW26(diag)# ping 192.168.2.22
Gateway      : 192.168.2.254
192.168.2.22 is alive.
```

```
FEL2P-SW26(diag)#
```

■ **firmware**

set upgrade-path

Syntax:

```
set upgrade-path <filepath>
```

Description:

To set upgrade file path and name on switch.

Argument:

<filepath>: upgrade file path and name

Possible value:

<filepath>: upgrade file path and name

Example:

```
FEL2P-SW26 (firmware)# set upgrade-path icpdas_ms6226_v0.99.img
```

show

Syntax:

```
show
```

Description:

To display the information of tftp server and upgrade-path and file name.

Argument:

None.

Possible value:

None.

Example:

```
FEL2P-SW26(firmware)# show
TFTP Server IP Address: 192.168.3.111
Path and Filename      : icpdas_ms2226_v0.99.img
```

upgrade

Syntax:

upgrade

Description:

To run the software upgrade function.

Argument:

None.

Possible value:

None.

Example:

```
FEL2P-SW26 (firmware)# upgrade
```

Upgrading firmware ...

■ **gvrp**

disable

Syntax:

disable

Description:

To disable the gvrp function

Argument:

None.

Possible value:

None.

Example:

```
FEL2P-SW26 (gvrp)# disable
```

enable

Syntax:

enable

Description:

To enable the gvrp function.

Argument:

None.

Possible value:

None.

Example:

```
FEL2P-SW26 (gvrp)# enable
```

group

Syntax:

group <group number>

Description:

To enter any of gvrp group for changing gvrp group setting. You can change the applicant or registrar mode of existing gvrp group per port.

Argument:

<group number>: enter which gvrp group you had created, using value is vid.

Available range: 1 to 4094

Possible value:

<group number>: 1~4094

Example:

```
FEL2P-SW26 (gvrp)# show group
GVRP group information
Current Dynamic Group Number: 1
VID Member Port
```

```
-----
2      5
```

```
FEL2P-SW26 (gvrp)# group 2
FEL2P-SW26 (gvrp-group-2)# set applicant 1-6 non-participant
```

```
FEL2P-SW26 (gvrp-group-2)# show
GVRP group VID: 2
Port Applicant      Registrar
```

```
-----
1      Non-Participant Normal
2      Non-Participant Normal
3      Non-Participant Normal
4      Non-Participant Normal
5      Non-Participant Normal
6      Non-Participant Normal
7      Normal          Normal
8      Normal          Normal
12     Normal          Normal
13     Normal          Normal
      :
      :
23     Normal          Normal
24     Normal          Normal
25     Normal          Normal
26     Normal          Normal
```

```
FEL2P-SW26 (gvrp-group-2)# set registrar 1-10 fixed
```

```
FEL2P-SW26 (gvrp-group-2)# show
GVRP group VID: 2
Port Applicant      Registrar
```

```
-----
1      Non-Participant Fixed
2      Non-Participant Fixed
3      Non-Participant Fixed
4      Non-Participant Fixed
5      Non-Participant Fixed
```

6	Non-Participant	Fixed
7	Normal	Fixed
8	Normal	Fixed
9	Normal	Fixed
10	Normal	Fixed
17	Normal	Normal
	:	:
23	Normal	Normal
24	Normal	Normal
25	Normal	Normal
26	Normal	Normal

set applicant

Syntax:

set applicant <range> <normal|non-participant>

Description:

To set default applicant mode for each port.

Argument:

<range>: port range, syntax 1,5-7, available from 1 to 26

<normal>: set applicant as normal mode

<non-participant>: set applicant as non-participant mode

Possible value:

<range>: 1 to 26

<normal|non-participant>: normal or non-participant

Example:

```
FEL2P-SW26 (gvrp)# set applicant 1-10 non-participant
```

set registrar

Syntax:

set registrar <range> <normal | fixed | forbidden>

Description:

To set default registrar mode for each port.

Argument:

<range>: port range, syntax 1,5-7, available from 1 to 26

<normal>: set registrar as normal mode

<fixed>: set registrar as fixed mode

<forbidden>: set registrar as forbidden mode

Possible value:

<range>: 1 to 26

<normal|fixed|forbidden>: normal or fixed or forbidden

Example:

```
FEL2P-SW26 (gvrp)# set registrar 1-5 fixed
```

set restricted

Syntax:

set restricted <range> <enable | disable>

Description:

To set the restricted mode for each port.

Argument:

<range>: port range, syntax 1,5-7, available from 1 to 26

<enable>: set restricted as enabled

<disable>: set restricted as disabled

Possible value:

<range>: 1 to 26

<enable | disable>: enable or disable

Example:

```
FEL2P-SW26 (gvrp)# set restricted 1-10 enable
```

```
FEL2P-SW26 (gvrp)# show config
```

```
GVRP state: Enable
```

Port	Join Time	Leave Time	LeaveAll Time	Applicant	Registrar	Restricted
1	20	60	1000	Normal	Normal	Enable
2	20	60	1000	Normal	Normal	Enable
3	20	60	1000	Normal	Normal	Enable
4	20	60	1000	Normal	Normal	Enable
5	20	60	1000	Normal	Normal	Enable
6	20	60	1000	Normal	Normal	Enable
7	20	60	1000	Normal	Normal	Enable
8	20	60	1000	Normal	Normal	Enable
9	20	60	1000	Normal	Normal	Enable
10	20	60	1000	Normal	Normal	Enable
				:		
				:		
22	20	60	1000	Normal	Normal	Disable
23	20	60	1000	Normal	Normal	Disable
24	20	60	1000	Normal	Normal	Disable
25	20	60	1000	Normal	Normal	Disable
26	20	60	1000	Normal	Normal	Disable

set timer

Syntax:

```
set timer <range> <join> <leave> <leaveall >
```

Description:

To set gvrp join time, leave time, and leaveall time for each port.

Argument:

<range> : port range, syntax 1,5-7, available from 1 to 26

<join>: join timer, available from 20 to 100

<leave>: leave timer, available from 60 to 300

<leaveall>: leaveall timer, available from 1000 to 5000

Leave Time must equal double Join Time at least.

Possible value:

<range> : 1 to 26

<join>: 20 to 100

<leave>: 60 to 300

<leaveall>: 1000 to 5000

Example:

```
FEL2P-SW26 (gvrp)# set timer 2-8 25 80 2000
```

show config

Syntax:

```
show config
```

Description:

To display the gvrp configuration.

Argument:

None.

Possible value:

None.

Example:

```
FEL2P-SW26(gvrp)# show config
```

```
GVRP state: Disable
```

Port	Join Time	Leave Time	LeaveAll Time	Applicant	Registrar	Restricted
1	20	60	1000	Normal	Normal	Disable
2	20	60	1000	Normal	Normal	Disable
3	20	60	1000	Normal	Normal	Disable
4	20	60	1000	Normal	Normal	Disable
			:			
			:			
			:			
23	20	60	1000	Normal	Normal	Disable
24	20	60	1000	Normal	Normal	Disable
25	20	60	1000	Normal	Normal	Disable
26	20	60	1000	Normal	Normal	Disable

show counter

Syntax:

```
show counter <port>
```

Description:

To show counter of the port.

Argument:

<port>: port number, available from 1 to 26

Possible value:

<port>: 1 to 26

Example:

```
FEL2P-SW26(gvrp)# show counter 2
```

```
GVRP Counter port: 2
```

Counter Name	Received	Transmitted
Total GVRP Packets	0	0
Invalid GVRP Packets	0	----
LeaveAll message	0	0
JoinEmpty message	0	0
JoinIn message	0	0
LeaveEmpty message	0	0

Empty message

0

0

show group

Syntax:

show group

Description:

To show the gvrp group.

Argument:

None.

Possible value:

None.

Example:

```
FEL2P-SW26(gvrp)# show group
```

GVRP group information

Current Dynamic Group Number: 0

VID Member Port

■ **hostname**

hostname

Syntax:

hostname <name>

Description:

To set up the hostname of the switch.

Argument:

<name>: hostname, max. 40 characters.

Possible value:

<name>: hostname, max. 40 characters.

Example:

```
FEL2P-SW26 # hostname Company
```

```
Company#
```

■ **multicast**

add group-filter

Syntax:

add group-filter <vid> <start> <end> <port>

Description:

To add group filter function on switch.

Argument:

<vid>: from 1 to 4094 value.

<start>: ip address format.

<end>: ip address format.

<port> syntax: 1,5-7, from 1 to 26 value.

Possible value:

<vid>: from 1 to 4094 value.

<start>: ip address format.

<end>: ip address format.

<port> syntax: 1,5-7, from 1 to 26 value.

Example:

```
FEL2P-SW26(multicast)# add group-filter 2 224.1.1.1 230.255.255.255 10-15
```

```
FEL2P-SW26(multicast)# show group-filtering 2
```

```
Index          : 1
```

```
Start Address  : 224.1.1.1
```

```
End Address    : 230.255.255.255
```

```
Port Member    : 10,11,12,13,14,15
```

```
FEL2P-SW26(multicast)#
```

add igmp-vlan**Syntax:**

```
add igmp-vlan <vid>
```

Description:

To add igmp vlan function on switch.

Argument:

<vid>: from 1 to 4094 value.

Possible value:

<vid>: from 1 to 4094 value.

Example:

```
FEL2P-SW26(multicast)# add igmp-vlan 3
```

```
FEL2P-SW26(multicast)# show igmp-vlan
```

Index	VID
1	1
2	2
3	3

deletegroup-filter**Syntax:**

```
delete group-filter <vid> <index>
```

Description:

To delete group-filter function on switch.

Argument:

<vid>: from 1 to 4094 value.

<index>: from 1 to 16 value.

Possible value:

<vid>: from 1 to 4094 value.

<index>: from 1 to 16 value.

Example:

```
FEL2P-SW26(multicast)# delete group-filter 2 1
```

```
FEL2P-SW26(multicast)# show group-filtering 2
```

None entry exist.

```
FEL2P-SW26(multicast)#
```

delete igmp-vlan

Syntax:

```
delete igmp-vlan <vid>
```

Description:

To delete igmp-vlan function on switch.

Argument:

<vid>: from 1 to 4094 value.

Possible value:

<vid>: from 1 to 4094 value.

Example:

```
FEL2P-SW26(multicast)# delete igmp-vlan 2
```

```
FEL2P-SW26(multicast)# show igmp-vlan
```

Index	VID
1	1
2	3

```
FEL2P-SW26(multicast)#
```

edit group-filter

Syntax:

```
edit group-filter <vid> <index> <start> <end> <port>
```

Description:

To delete igmp-vlan function on switch.

Argument:

<vid>: from 1 to 4094 value.

<index>: from 1 to 16 value.

<start>: ip address format.

<end>: ip address format.

<port> syntax: 1,5-7, from 1 to 26 value..

Possible value:

<vid>: from 1 to 4094 value.

<index>: from 1 to 16 value.

<start>: ip address format.

<end>: ip address format.

<port> syntax: 1,5-7, from 1 to 26 value..

Example:

```
FEL2P-SW26(multicast)# add group-filter 3 224.1.1.1 225.255.255.255 10-15
```

```
FEL2P-SW26(multicast)# show group-filtering 3
```

```
Index          : 1
```

```
Start Address  : 224.1.1.1
```

```
End Address    : 225.255.255.255
```

```

Port Member      : 10, 11, 12, 13, 14, 15
FEL2P-SW26(multicast)# edit group-filter 3 1 224.1.1.1 226.255.255.255 10-
11
FEL2P-SW26(multicast)# show group-filtering 3
Index           : 1
Start Address   : 224.1.1.1
End Address     : 226.255.255.255
Port Member     : 10, 11

```

set unregfld-enable

Syntax:

```
set unregfld-enable <state>
```

Description:

To set unregister multicast flooding state function on switch.

Argument:

<state>: 0(disable), 1(enable)

Possible value:

<state>: 0(disable), 1(enable)

Example:

```

FEL2P-SW26(multicast)# set unregfld-enable 1
FEL2P-SW26(multicast)# show igmp-setting
IGMP Snooping                : Enable
Unregister Multicast Flooding : Enable
General Query Interval       : 125
General Query Max Response Time : 10
General Query Timeout        : 11
Specific Query Count         : 2
Specific Query Max Response Time : 1
Specific Query Timeout       : 2

```

Port	Multicast Group Limit	IGMP Router
1	256	
2	256	
3	256	
4	256	
5	256	
6	256	
7	256	
8	256	
9	256	
10	256	v
11	256	v
12	256	v

... (q to quit)

set gnlqry-interval

Syntax:

set gnlqry-interval <sec>

Description:

To set general query interval function on switch.

Argument:

<sec>: from 1 to 2000 value.

Possible value:

<sec>: 1 to 2000 .

Example:

```
FEL2P-SW26(multicast)# set gnlqry-interval 20
```

set gnlqry-response

Syntax:

set gnlqry-response <sec>

Description:

To set general query max response time

Argument:

<sec>: from 1 to 10 value.

Possible value:

<sec>: 1 to 10 .

Example:

```
FEL2P-SW26(multicast)# set gnlqry-response 5
```

set gnlqry-timeout

Syntax:

set gnlqry-response <sec>

Description:

To set general query timeout

Argument:

<sec>: from 1 to 30 value.

Possible value:

<sec>: 1 to 30 .

Example:

```
FEL2P-SW26(multicast)# set gnlqry-timeout 15
```

set group-limit

Syntax:

set group-limit <port> <limit>

Description:

To set multicast group limit

Argument:

<port> syntax: 1,5-7, from 1 to 26 value.

<limit>: from 0 to 256 value

Possible value:

<port>: 1 to 26.

<limit>: 0 to 256.

Example:

```
FEL2P-SW26(multicast)# set group-limit 10-12 55
FEL2P-SW26(multicast)# show igmp-setting
IGMP Snooping                : Enable
Unregister Multicast Flooding : Enable
General Query Interval       : 20
General Query Max Response Time : 5
General Query Timeout        : 15
Specific Query Count         : 2
Specific Query Max Response Time : 1
Specific Query Timeout       : 2
```

Port	Multicast Group Limit	IGMP Router
1	256	
2	256	
3	256	
4	256	
5	256	
6	256	
7	256	
8	256	
9	256	
10	55	v
11	55	v
12	55	v

... (q to quit)

set igmpsnp-enable

Syntax:

set igmpsnp-enable <state>

Description:

To set igmp snooping state

Argument:

<state>: 0(disable), 1(enable).

Possible value:

<state>: 0(disable), 1(enable).

Example:

```
FEL2P-SW26(multicast)# set igmpsnp-enable 0
FEL2P-SW26(multicast)# show igmp-setting
IGMP Snooping                : Disable
Unregister Multicast Flooding : Enable
General Query Interval        : 20
General Query Max Response Time : 5
General Query Timeout         : 15
Specific Query Count          : 2
Specific Query Max Response Time : 1
Specific Query Timeout        : 2
```

Port	Multicast Group Limit	IGMP Router
1	256	
2	256	
3	256	
4	256	
5	256	
6	256	
7	256	
8	256	
9	256	
10	55	v
11	55	v
12	55	v

... (q to quit)

set igmp-router

Syntax:

set igmp-router <port> <state>

Description:

To set igmp router port

Argument:

<port> syntax: 1,5-7, from 1 to 26 value.

<state>: 0(non-router), 1(router).

Possible value:

<port> : 1 to 26.

<state>: 0(non-router), 1(router).

Example:

```
FEL2P-SW26(multicast)# set igmp-router 5-7 1
FEL2P-SW26(multicast)# show igmp-setting
IGMP Snooping                : Enable
Unregister Multicast Flooding : Enable
General Query Interval        : 20
General Query Max Response Time : 5
General Query Timeout         : 15
Specific Query Count          : 2
```

Specific Query Max Response Time : 1
Specific Query Timeout : 2

Port	Multicast Group Limit	IGMP Router
1	256	
2	256	
3	256	
4	256	
5	256	v
6	256	v
7	256	v
8	256	
9	256	
10	55	v
11	55	v
12	55	v

... (q to quit)

set mvr-enable

Syntax:

set mvr-enable <state> <mvid>

Description:

To set igmp router port

Argument:

<state>: 0(disable), 1(enable).

<mvid>: from 1 to 4094 value.

When set mvr to enable mode, this option is necessary.

Possible value:

<state>: 0(disable), 1(enable).

<mvid>: 1 to 4094.

Example:

FEL2P-SW26(multicast)# set mvr-enable 1 3

set mvr-tagging

Syntax:

set mvr-tagging <port> <state>

Description:

To set mvr tagging function on switch

Argument:

<port> syntax: 1,5-7, from 1 to 26 value.

<state>: 0(untag-out), 1(tag-out).

Possible value:

<port> : 1 to 26.

<state>: 0(untag-out), 1(tag-out)

Example:

```
FEL2P-SW26(multicast)# set mvr-tagging 8-10 1
FEL2P-SW26(multicast)# show mvr-setting
Multicast VLAN Registration : Enable
MMulticast VLAN ID          : 0
```

Port	Service Type	Tagging
1	None	
2	None	
3	None	
4	None	
5	None	
6	None	
7	None	
8	None	v
9	None	v
10	None	v
11	None	
12	None	
13	None	
14	None	
15	None	
16	None	
17	None	
18	None	

... (q to quit)

set mvr-vid

Syntax:

```
set mvr-vid <vid>
```

Description:

To set mvr vid on switch

Argument:

<vid>: from 1 to 4094 value

Possible value:

<vid>: from 1 to 4094 value

Example:

```
FEL2P-SW26(multicast)# set mvr-vid 3
```

set mvrser-vtype

Syntax:

set mvrser-vtype <port> <type>

Description:

To set mvr service type

Argument:

<port> syntax: 1,5-7, from 1 to 26 value.

<type>: 0(None), 1(Client), 2(Router).

Possible value:

<port> : 1 to 26.

<type>: 0(None), 1(Client), 2(Router).

Example:

```
FEL2P-SW26(multicast)# set mvrser-vtype 6-8 1
FEL2P-SW26(multicast)# set mvrser-vtype 9-10 2
FEL2P-SW26(multicast)# show mvr-setting
Multicast VLAN Registration : Enable
MMulticast VLAN ID          : 0
```

Port	Service Type	Tagging
------	--------------	---------

1	None	
2	None	
3	None	
4	None	
5	None	
6	Client	
7	Client	
8	Client	v
9	Router	v
10	Router	v
11	None	
12	None	
13	None	
14	None	
15	None	
16	None	
17	None	
18	None	

... (q to quit)

set specqry-count

Syntax:

set specqry-count <cnt>

Description:

To set specific query count function on switch

Argument:

<cnt>: from 1 to 10 value.

Possible value:

<cnt>: from 1 to 10 value.

Example:

```
FEL2P-SW26(multicast)# set specqry-count 5
```

set specqry-response

Syntax:

set specqry-response <time>

Description:

To set specific query max response time on switch.

Argument:

<time>: from 1 to 10 value.

Possible value:

<time>: 1 to 10.

Example:

```
FEL2P-SW26(multicast)# set specqry-response 2
```

Specific Query Max Response Time must less than Specific Query Timeout

```
FEL2P-SW26(multicast)# set specqry-response 1
```

set specqry-timeout

Syntax:

set specqry-timeout <time>

Description:

To set specific query timeout on switch.

Argument:

<time>: from 1 to 30 value.

Possible value:

<time>: 1 to 30.

Example:

```
FEL2P-SW26(multicast)# set specqry-timeout 20
```

```
FEL2P-SW26(multicast)# show igmp-setting
```

```
IGMP Snooping                : Enable
```

```
Unregister Multicast Flooding  : Enable
```

```
General Query Interval        : 20
```

```
General Query Max Response Time : 5
```

```
General Query Timeout         : 15
```

```
Specific Query Count          : 5
```

```
Specific Query Max Response Time : 1
```

```
Specific Query Timeout        : 20
```

Port Multicast Group Limit IGMP Router

```

-----
 1          256
 2          256
 3          256
 4          256
 5          256          v
 6          256          v
 7          256          v
 8          256
 9          256
10          55          v
11          55          v
12          55          v
... (q to quit)

```

show group-filtering

Syntax:

show group-filtering <vid>

Description:

To show group filtering on switch.

Argument:

<vid>: from 1 to 4094 value.

Possible value:

<vid>: 1 to 4094.

Example:

```

FEL2P-SW26(multicast)# show group-filtering 3
Index      : 1
Start Address : 224.1.1.1
End Address  : 226.255.255.255
Port Member  : 10,11

```

```

FEL2P-SW26(multicast)#

```

show igmp-setting

Syntax:

show igmp-setting

Description:

To show igmp-setting on switch.

Argument:

none

Possible value:

none

Example:

```

FEL2P-SW26(multicast)# show igmp-setting
IGMP Snooping          : Enable
Unregister Multicast Flooding : Enable

```

```

General Query Interval      : 20
General Query Max Response Time : 5
General Query Timeout      : 15
Specific Query Count       : 5
Specific Query Max Response Time : 1
Specific Query Timeout     : 20

```

```

Port  Multicast Group Limit  IGMP Router
-----
  1           256
  2           256
  3           256
  4           256
  5           256          v
  6           256          v
  7           256          v
  8           256
  9           256
 10          55           v
 11          55           v
 12          55           v
... (q to quit)

```

show igmp-vlan

Syntax:

```
show igmp-vlan
```

Description:

To show igmp-vlan on switch.

Argument:

none

Possible value:

none

Example:

```
FEL2P-SW26(multicast)# show igmp-vlan
```

```

Index  VID
-----
  1     1
  2     3

```

```
FEL2P-SW26(multicast)#
```

show multicast-status

Syntax:

```
show multicast-status
```

Description:

To show multicast-status on switch.

Argument:

none

Possible value:

none

Example:

```
FEL2P-SW26(multicast)# show multicast-status ?
```

None entry exist.

```
FEL2P-SW26(multicast)#
```

show mvr-setting

Syntax:

```
show mvr-setting
```

Description:

To show mvr-setting on switch.

Argument:

none

Possible value:

none

Example:

```
FEL2P-SW26(multicast)# show mvr-setting
```

```
Multicast VLAN Registration : Enable
```

```
MMulticast VLAN ID          : 0
```

```
Port  Service Type  Tagging
```

```
----  -
```

```
1      None
```

```
2      None
```

```
3      None
```

```
4      None
```

```
5      None
```

```
6      Client
```

```
7      Client
```

```
8      Client      v
```

```
9      Router      v
```

```
10     Router      v
```

```
11     None
```

```
12     None
```

```
13     None
```

```
14     None
```

```
15     None
```

```
16     None
```

```
17     None
```

```
18     None
```

```
... (q to quit)
```

■ IP

disable dhcp

Syntax:

disable dhcp

Description:

To disable the DHCP function of the system.

Argument:

None.

Possible value:

None.

Example:

```
FEL2P-SW26(ip)# disable dhcp
DHCP is already stopped.
```

enable dhcp

Syntax:

enable dhcp <manual | auto>

Description:

To enable the system DHCP function and set DNS server via manual or auto mode.

Argument:

<manual|auto> : set DNS by using manual or auto mode.

Possible value:

<manual|auto> : manual or auto

Example:

```
FEL2P-SW26(ip)# enable dhcp manual
```

set dns

Syntax:

set dns <ip>

Description:

To set the IP address of DNS server.

Argument:

<ip> : dns ip address

Possible value:

<ip> : 168.95.1.1

Example:

```
FEL2P-SW26 (ip)# set dns 168.95.1.1
```

set ip

Syntax:

set ip <ip> <mask> <gateway>

Description:

To set the system IP address, subnet mask and gateway.

Argument:

<ip> : ip address

<mask> : subnet mask

<gateway> : default gateway

Possible value:

<ip> : 192.168.1.1 or others

<mask> : 255.255.255.0 or others

<gateway> : 192.168.1.253 or others

Example:

```
FEL2P-SW26 (ip)# set ip 192.168.1.2 255.255.255.0 192.168.1.253
```

```
FEL2P-SW26(ip)# show
```

```
DHCP                : Disable
IP Address          : 192.168.1.2
Subnet mask         : 255.255.255.0
Gateway             : 192.168.1.253
Current IP Address  : 192.168.1.10
Current Subnet mask : 255.255.255.0
Current Gateway     : 192.168.1.254
DNS Setting         : Manual
DNS Server          : 0.0.0.0
```

show

Syntax:

show

Description:

To display the system's DHCP function state, IP address, subnet mask, default gateway, DNS mode, DNS server IP address and current IP address.

Argument:

None.

Possible value:

None.

Example:

```
FEL2P-SW26(ip)# show
```

```
DHCP                : Disable
IP Address          : 192.168.1.2
Subnet mask         : 255.255.255.0
Gateway             : 192.168.1.253
Current IP Address  : 192.168.1.10
Current Subnet mask : 255.255.255.0
Current Gateway     : 192.168.1.254
DNS Setting         : Manual
DNS Server          : 0.0.0.0
```

■ log

clear

Syntax:

clear

Description:

To clear the log data.

Argument:

None.

Possible value:

None.

Example:

```
FEL2P-SW26 (log)# clear
```

disable auto-upload

Syntax:

disable auto-upload

Description:

To disable the auto-upload function.

Argument:

None.

Possible value:

None.

Example:

```
FEL2P-SW26 (log)# disable auto-upload
```

enable auto-upload

Syntax:

enable auto-upload

Description:

To enable the auto-upload function.

Argument:

None.

Possible value:

None.

Example:

```
FEL2P-SW26 (log)# enable auto-upload
```

show

Syntax:

show

Description:

To show a list of trap log events. When any of log events happens, it will be recorded and using show command in log function to query. Up to 120 log records are supported.

Argument:

None.

Possible value:

None.

Example:

```
FEL2P-SW26(log)# show
```

```
Tftp Server : 192.168.2.2
```

```
Auto Upload : Enable
```

- 1) Thu Apr 03 14:45:17 2008 Login [admin]
- 2) Thu Apr 03 14:43:59 2008 Link Up [Port 7]
- 3) Thu Apr 03 14:43:56 2008 Link Down [Port 7]
- 4) Thu Apr 03 14:15:03 2008 Logout [admin]
- 5) Thu Apr 03 13:06:07 2008 Login [admin]
- 6) Thu Apr 03 13:05:15 2008 Warm Start

```
FEL2P-SW26(log)#
```

upload

Syntax:

Upload

Description:

To upload log data through tftp.

Argument:

None.

Possible value:

None.

Example:

```
FEL2P-SW26 (log)# upload
```

■ LLDP

<<set clear>>

set

Syntax:

set clear

Description:

Resets the traffic and error counters to zero.

Argument:

None

Possible value:

None

Example:

```
FEL2P-SW26(11dp)# set clear
```

```
FEL2P-SW26(11dp)#
```

set mode

Syntax:

set mode <mode> <range>

Description:

To set LLDP mode

Argument:

tx and rx = 1

tx only = 2

rx only = 3

disabled = 0

port range syntax : 1,5-7, available from 1 to 27

Possible value:

<Port range> : 1 to 10, <mode>: 0-3

Example:

```
FEL2P-SW26(11dp)# set mode 1 5
```

```
FEL2P-SW26(11dp)#
```

set notification

Syntax:

set notification <state> <range>

Description:

To set LLDP notification

Argument:

enable = 1

disable = 2

Possible value:

<Port range> : syntax : 1,5-7, available from 1 to 26, <state>: 1, 2

Example:

```
FEL2P-SW26(11dp)# set notification 1 5
```

```
FEL2P-SW26(11dp)#
```

set reInitDelay

Syntax:

set reInitDelay <time>

Description:

To set LLDP reInitDelay time

Argument:

<Time> : from 1 to 10 second(s)

Possible value:

<Time> : from 1 to 10 second(s)

Example:

```
FEL2P-SW26(11dp)# set reInitDelay 5
FEL2P-SW26(11dp)#
```

set tlv

Syntax:

set tlv <0> <1> <2> <3> <4> <range>

Description:

To set disable/enable lldp tlv

Argument:

Port Description: bit 0

System Name: bit 1

System Description: bit 2

System Capabilities: bit 3

Management Address: bit 4

port range syntax : 1,5-7, available from 1 to 10, <Port Description>: 0/1, <System Name> :0/1, <System Description> : 0/1, < System Capabilities>: 0/1, < Management Address>: 0/1

Possible value:

<Port Range> : syntax : 1,5-7, available from 1 to 10

Example:

```
FEL2P-SW26(11dp)# set tlv 1 1 1 1 1 1-10
FEL2P-SW26(11dp)#
```

set txDelay

Syntax:

set txDelay <time>

Description:

To set lldp txdelay

Argument:

<time>: from 1 to 8192 second(s)

Possible value:

<time>: from 1 to 8192 second(s)

Example:

```
FEL2P-SW26(11dp)# set txDelay 500
```

FEL2P-SW26(11dp)#

set txHold

Syntax:

set txHold <time>

Description:

To set lldp txHold

Argument:

<time>: from 2 to 10 second(s)

Possible value:

<time>: from 2 to 10 second(s)

Example:

```
FEL2P-SW26(11dp)# set txHold 5
```

```
FEL2P-SW26(11dp)#
```

set txInterval

Syntax:

set txInterval <time>

Description:

To set lldp txInterval

Argument:

<time>: from 5 to 32768 second(s)

Possible value:

<time>: from 5 to 32768 second(s)

Example:

```
FEL2P-SW26(11dp)# set txInterval 5
```

```
FEL2P-SW26(11dp)#
```

show config

Syntax:

Show config

Description:

To display LLDP Configuration

Argument:

None

Possible value:

none

Example:

```
FEL2P-SW26(11dp)# show config
```

LLDP Global Configuration

```
LLDP Transmit Interval    [30] : 5
LLDP Hold time Multiplier [4]  : 5
LLDP Delay Interval       [2]  : 1
LLDP Reinit Interval      [2]  : 5
```

LLDP Notification Interval [5] : 500

LLDP Port Configuration

Port	AdminStatus	NotificationEnabled
1	Disable	False
2	Disable	False
3	Disable	False
4	Disable	False
5	Disable	True
6	Disable	False
7	Disable	False
8	Disable	False
9	Disable	False
10	Disable	False

FEL2P-SW26(11dp)#

show detail counter

Syntax:

show detail-counter <port>

Description:

To display LLDP detail counter

Argument:

<port>: 1,5-9, available from 1 to 10

Possible value:

<port>: 1,5-9, available from 1 to 10

Example:

```
FEL2P-SW26(11dp)# show detail-counter 15
LLDP Port Statistics Detail
```

```
Port Name : 15
Frames Discarded : 0
Frames Invalid : 0
Frames REceived : 0
Frames Sent : 0
TLVs Unrecognized : 0
TLVs Discard : 0
Neighbor Ageouts : 0
FEL2P-SW26(11dp)#
```

show local-device

Syntax:

show local-device

Description:

To display LLDP local device

Argument:

None

Possible value:

None

Example:

```
FEL2P-SW26(11dp)# show local-device
```

LLDP Local Devices Information

Chassis Type : MAC-address

Chassis Id : 00-A0-57-15-2A-F7

System name = FEL2P-SW26

System Description : 24-Port FEL2 Plus Managed Switch with 2 SFP Dual

Media

System Capabilities Supported : bridge

System Capabilities Enabled : bridge

Management Address :

 Type : ipv4

 Address : 192 . 168. 20 . 15

LLDP Port Information

Port	PortType	PortId	PortDesc
1	local	1	Port #1
2	local	2	Port #2
3	local	3	Port #3
4	local	4	Port #4
5	local	5	Port #5
6	local	6	Port #6
7	local	7	Port #7
8	local	8	Port #8
9	local	9	Port #9
10	local	10	Port #10

```
FEL2P-SW26(11dp)#
```

show Neighbor

Syntax:

```
show neighbor <port>
```

Description:

To display LLDPneighbor

Argument:

<port>: 1,5-9, available from 1 to 26.

Possible value:

<port>: 1,5-9, available from 1 to 26.

Example:

```
FEL2P-SW26(11dp)# show Neighbor 1
```

LLDP Remote Devices Information

FEL2P-SW26(11dp)#

show port-config

Syntax:

show port-config <port>

Description:

To display LLDPport config

Argument:

<port>: 1,5-9, available from 1 to 26.

Possible value:

<port>: 1,5-9, available from 1 to 26.

Example:

```
FEL2P-SW26(11dp)# show port-config 5
```

LLDP Port Configuration Detail

```
Port : 5
AdminStatus [Tx_Rx] : Disable
NotificationEnabled [False] : True
```

TLVs Advertised :

```
FEL2P-SW26(11dp)#
```

```
FEL2P-SW26(11dp)#
```

show stats

Syntax:

show stats

Description:

To display LLDP stats

Argument:

None

Possible value:

None

Example:

```
FEL2P-SW26(11dp)# show stats
```

LLDP Device Statistics

```
Neighbor Entries List Last Updated : 5850 sec. ago
```

```
New Neighbor Entries Count : 0
```

```
Neighbor Entries Deleted Count : 0
```

```
Neighbor Entries Dropped Count : 0
```

```
Neighbor Entries AgeOut Count : 0
```

LLDP Port Statistics

Port	Tx Frames	Rx Frames	Rx Errors	Rx Discards	TLV Discards	TLV Unknown	Aged
1	0	0	0	0	0	0	0
2	0	0	0	0	0	0	0
3	0	0	0	0	0	0	0
4	0	0	0	0	0	0	0
5	0	0	0	0	0	0	0
..

FEL2P-SW26(11dp)#

■ mac-table

<<alias>>

del

Syntax:

del <mac>

Description:

To delete the mac alias entry.

Argument:

<mac> : mac address, format: xx-xx-xx-xx-xx-xx

Possible value:

<mac> : mac address

Example:

FEL2P-SW26(mac-table-alias)# del 00-e5-55-c9-93-c9

set

Syntax:

set <mac> <alias>

Description:

To set up the mac alias entry.

Argument:

<mac> : mac address, format: xx-xx-xx-xx-xx-xx

<alias> : mac alias name, max. 15 characters

Possible value:

<mac> : mac address

<alias> : max. 15 characters

Example:

FEL2P-SW26(mac-table-alias)# set 00-d0-59-c5-92-c8 client1

show

Syntax:

show

Description:

To display the mac alias entry.

Argument:

None.

Possible value:

None.

Example:

FEL2P-SW26(mac-table-alias)# show

MAC Alias List

	MAC Address	Alias
1)	00-d0-59-c5-92-c8	client1
2)	00-e5-55-c9-93-c9	client2

<<information>>

search**Syntax:**

search <port> <mac> <vid>

Description:

To look for the relative mac information in mac table.

Argument:<port> : set up the range of the ports to search for,
syntax 1,5-7, available form 1 to 26

<mac> : mac address, format: 01-02-03-04-05-06, '?' can be used

<vid> : vlan id, from 1 to 4094; '?' as don't care, 0 as untagged

Possible value:

<port> : 1 to 26

<vid> : 0, 1 ~4094

Example:

FEL2P-SW26(mac-table-information)# search 7 00-d0-59-c5-92-c8 1

MAC Table List

Alias	MAC Address	Port	VID	State
client1	00-D0-59-C5-92-C8	7	1	Dynamic

FEL2P-SW26(mac-table-information)#

show**Syntax:**

show

Description:

To display all mac table information.

Argument:

None.

Possible value:

None.

Example:

FEL2P-SW26 (mac-table-information)# show

MAC Table List

Alias	MAC Address	Port	VID	State
			233	

	00-C0-26-C3-3F-37	1	1	Dynamic
	00-C0-9F-71-12-24	1	1	Dynamic
client2	00-D0-59-C5-92-C8	7	1	Dynamic
	00-E0-18-6C-9E-DA	1	1	Dynamic
	00-E0-18-DF-91-DD	1	1	Dynamic
	52-54-4C-39-3A-38	1	1	Dynamic

<<maintain>>

flush

Syntax:

flush

Description:

To flush MAC table.

Argument:

none

Possible value:

none

Example:

FEL2P-SW26(mac-table-maintain)# flush

set aging

Syntax:

set aging <time>

Description:

To set up the age out time of dynamic learning mac.

Argument:

<time> : Mac table age out time between 10 and 1000000 seconds

set time to 0 as disable age out time

Possible value:

<time> : 10-1000000 seconds or 0

Example:

FEL2P-SW26(mac-table-maintain)# set aging 300

set learning

Syntax:

set learning <port> <num>

Description:

To set up the maximum amount of MAC that each port can learn.

Argument:

<port> syntax: 1,5-7, available from 1 to 26

<num> : MAC address numbers which can be dynamically learned

num range: between 0 to 8191; 0 for learning disabled

Possible value:

<port> : 1 to 26

<num>: 0 to 8191

Example:

FEL2P-SW26 (mac-table-maintain)# set learning 5 100

show

Syntax:

show

Description:

To display the settings of MAC table ageout time and the learning limit of each port.

Argument:

None.

Possible value:

None.

Example:

```
FEL2P-SW26(mac-table-maintain)# show
```

```
Mac table ageout time: 300 seconds
```

```
Port    Dynamically learn limit
```

```
-----
```

```
1      8191
```

```
2      8191
```

```
3      8191
```

```
4      8191
```

```
5      8191
```

```
:
```

```
:
```

```
:
```

```
21     8191
```

```
22     8191
```

```
23     8191
```

```
24     8191
```

```
25     8192
```

```
26     8192
```

<<port-security>>

disable

Syntax:

disable

Description:

To disable port security.

Argument:

none

Possible value:

none

Example:

```
FEL2P-SW26(mac-table-port-security)# disable
```

enable

Syntax:

enable

Description:

To enable port security.

Argument:

none

Possible value:

none

Example:

```
FEL2P-SW26(mac-table-port-security)# enable
```

<<port>>

Syntax:

port <range>

Description:

To enter into per port static mac mode.

Argument:

<range> : syntax: 1,5-7, available from 1 to 26

Possible value:

<range> : 1 to 26

Example:

```
FEL2P-SW26(mac-table-port-security)# port 10
```

```
FEL2P-SW26(mac-table-port-security-port-10)#
```

```
FEL2P-SW26(mac-table-port-security-port-10)# add 00-d0-59-c5-92-c8 2
```

```
FEL2P-SW26(mac-table-port-security-port-10)# show
```

```
Port 10 static mac entry:
```

```
-----  
No   MAC Address      VID  
1    00-D0-59-C5-92-C8  2
```

```
FEL2P-SW26(mac-table-port-security-port-10)# del 00-d0-59-c5-92-c8
```

```
FEL2P-SW26(mac-table-port-security-port-10)# show
```

```
Port 10 static mac entry:
```

```
-----  
(None)
```

```
FEL2P-SW26(mac-table-port-security-port-10)#
```

<<static-mac>>

add

Syntax:

add <mac> <vid> <rule> <port>

Description:

To add the static mac entry.

Argument:

<mac>: mac address, format: 01-02-03-04-05-06

<vid>: vlan id, from 1 to 4094

<rule> : forwarding rule, from 0 to 2

0:static

1:drop destination address matches

2:drop source address matches

<port> : forwarded destination port, form 1 to 26

Possible value:

<vid>: 1 to 4094

<rule>: 0 to 2

<port>: 1 to 26

Example:

```
FEL2P-SW26(mac-table-static-mac)# add 00-d0-59-c5-92-c8 1 1 8
```

```
FEL2P-SW26(mac-table-static-mac)# show
```

	MAC	VID	Forwarding Rule	Port
1)	00-D0-59-C5-92-C8	1	Static with Destination Drop	8

```
FEL2P-SW26(mac-table-static-mac)#
```

del**Syntax:**

del <mac>

Description:

To remove the static mac entry.

Argument:

<mac> : mac address, format: 00-02-03-04-05-06

Possible value:

<mac> : mac address

Example:

```
FEL2P-SW26(mac-table-static-mac)# del 00-d0-59-c5-92-c8
```

```
FEL2P-SW26(mac-table-static-mac)# show
```

	MAC	VID	Forwarding Rule	Port
--	-----	-----	-----------------	------

```
FEL2P-SW26(mac-table-static-mac)#
```

show**Syntax:**

show

Description:

To display static mac entry.

Argument:

None.

Possible value:

None.

Example:

```
FEL2P-SW26(mac-table-static-mac)# add 00-d0-59-c5-92-c8 1 1 8
```

```
FEL2P-SW26(mac-table-static-mac)# show
```

	MAC	VID	Forwarding Rule	Port
1)	00-D0-59-C5-92-C8	1	Static with Destination Drop	8

```
FEL2P-SW26(mac-table-static-mac)#
```

■ management***del*****Syntax:**

del <name>

Description:

To delete a management security entry

Argument:

<name> : management security entry name

Possible value:

<name> : management security entry name

Example:

```
FEL2P-SW26(management-add)# set name Mary vid 20 ip 192.168.1.1-
192.168.1.90 port 2-5,8 type h,s action a
```

set access**Syntax:**

set access <name> <range>

Description:

To setup access type field of a management security entry

Argument:

<name> : management security entry name

<range> syntax: 1,1-3, available from 0 to 3

1 - Http

2 - Telnet

3 - Snmp

0 - Any

Possible value:

<name> : management security entry name

<range> syntax: 1,1-3, available from 0 to 3

1 - Http

2 - Telnet

3 - Snmp

0 - Any

Example:

```
FEL2P-SW26(management)# set access acc2 1-3
```

```
FEL2P-SW26(management)# show
```

```
1) :  
Name      : acc1  
VID       : 2  
IP Range: 192.168.2.2-192.168.2.22  
Port      : 10  
Access    : Any  
Action    : Accept
```

```
2) :  
Name      : acc2  
VID       : Any  
IP Range: Any  
Port      : Any  
Access    : Http Telnet SNMP  
Action    : Deny
```

```
FEL2P-SW26(management)#
```

set action

Syntax:

```
set action <name> <act>
```

Description:

To setup action field of a management security entry

Argument:

<name> : management security entry name

<act> : 0 for deny, 1 for accept

Possible value:

<name> : management security entry name

<act> : 0 for deny, 1 for accept

Example:

```
FEL2P-SW26(management)# set action acc2 0
```

```
FEL2P-SW26(management)# show
```

```
1) :  
Name      : acc1  
VID       : 2  
IP Range: 192.168.2.2-192.168.2.22  
Port      : 10  
Access    : Any  
Action    : Accept
```

```
2) :  
Name      : acc2  
VID       : Any  
IP Range: Any  
Port      : Any
```

Access : Http Telnet SNMP
Action : Deny

FEL2P-SW26(management)#

set ip

Syntax:

set ip <name> <ip1> <ip2>

Description:

To setup ip field of a management security entry

Argument:

<name> : management security entry name

<ip1> : start ip address, 0 for any

<ip2> : end ip address

Possible value:

<name> : management security entry name

<ip1> : start ip address, 0 for any

<ip2> : end ip address

Example:

```
FEL2P-SW26(management)# set ip remotel 192.168.2.33 192.168.2.34
```

```
FEL2P-SW26(management)# show
```

```
1):
```

```
Name      : remotel
```

```
VID       : Any
```

```
IP Range: 192.168.2.33-192.168.2.34
```

```
Port      : Any
```

```
Access    : Any
```

```
Action    : Deny
```

```
FEL2P-SW26(management)#
```

set port

Syntax:

set port <name> <range>

Description:

To setup port field of a management security entry

Argument:

<name> : management security entry name

<range syntax> : 1,5-7, available from 0 to 26, 0 for any

Possible value:

<name> : management security entry name

<range syntax> : 1,5-7, available from 0 to 26, 0 for any

Example:

```
FEL2P-SW26(management)# set port remotel 9
```

```
FEL2P-SW26(management)# show
```

```
1):
```

```
Name      : remotel
```

```
VID       : Any
```

```
IP Range: 192.168.2.33-192.168.2.34
```

```
Port      : 9
```

```
Access    : Any
```

```
Action    : Deny
```

```
FEL2P-SW26(management)#
```

set vid

Syntax:

set vid <name> <vid>

Description:

To setup vid field of a management security entry

Argument:

<name> : management security entry name

<vid> : 0 for any, or 1 to 4094

Possible value:

<name> : management security entry name

<vid> : 0 for any, or 1 to 4094

Example:

```
FEL2P-SW26(management)# set vid remotel 300
```

```
FEL2P-SW26(management)# show
```

```
1):
```

```
Name      : remotel
```

```
VID       : 300
```

```
IP Range: 192.168.2.33-192.168.2.34
```

```
Port      : 9
```

Access : Any
Action : Deny

FEL2P-SW26 (management)#

show

Syntax:

show

Description:

To show management security entry.

Argument:

None

Possible value:

None.

Example:

```
FEL2P-SW26 (management)# show
 1):
Name      : remotel
VID       : 300
IP Range: 192.168.2.33-192.168.2.34
Port      : 9
Access    : Any
Action    : Deny
```

FEL2P-SW26 (management)#

■ **port**

clear counter

Syntax:

clear counter

Description:

To clear all ports' counter (include simple and detail port counter) information.

Argument:

None.

Possible value:

None.

Example:

```
FEL2P-SW26 (port)# clear counter
```

disable state

Syntax:

disable state <range>

Description:

To disable the communication capability of the port.

Argument:

<range>: port range, syntax 1,5-7, available from 1 to 26

Possible value:

<range>: 1 ~ 26

Example:

```
FEL2P-SW26 (port)# disable state 12
```

enable state**Syntax:**

```
enable state <range>
```

Description:

To enable the communication capability of the port.

Argument:

<range>: port range, syntax 1,5-7, available from 1 to 26

Possible value:

<range>: 1 ~ 26

Example:

```
FEL2P-SW26 (port)# enable state 3-10
```

set description**Syntax:**

```
set description <range> <description>
```

Description:

To set up the flow control function of all ports.

Argument:

<range> syntax: 1,5-7, available from 1 to 26

<description> : set its port description, max 47 characters

Possible value:

<range> : 1 to 26

<description> : set its port description, max 47 characters

Example:

```
FEL2P-SW26(port)# set description 6 Engineer
```

```
FEL2P-SW26(port)# show description
```

```
Port Description
```

```
-----: -0D-61-
```

```
1
```

```
2
```

```
3
```

```
4 RDTeam
```

```
5
```

```
6 Engineer
```

```
7
```

```
8 sales
```

9
10
11
12
13
.....

set flow-control

Syntax:

set flow-control <range> <symmetric | asymmetric>

Description:

To set up the flow control function of all ports.

Argument:

<range>:port range, syntax 1,5-7, available from 1 to 26

<symmetric>: set its flow control as symmetric

<asymmetric>: set its flow control as asymmetric

Possible value:

<range>: 1 to 26

<symmetric | asymmetric>:symmetric or asymmetric

Example:

```
FEL2P-SW26 (port)# set flow-control 3-6 asymmetric
```

set speed-duplex

Syntax:

set speed-duplex <range> <auto>[<10|100|1000> <half | full>]

Description:

To set up the speed and duplex of all ports.

Argument:

<range>:port range, syntax 1,5-7, available from 1 to 26

<port-speed>:

auto : set auto-negotiation mode

10 : set speed to 10M

100 : set speed to 100M

1000 : set speed to 1000M

<port-duplex> :

half : set to half duplex

full : set to full duplex

Possible value:

<range>: 1 to 26

<port-speed> : auto, 10, 100, 1000

<port-duplex> : full, half

Example:

```
FEL2P-SW26(port)# set speed-duplex 10-15 10 full
```

```
FEL2P-SW26(port)# show status
```

```
asymmetric: set
```

5	TP	Up	Enable	Enable	100M/Full	ON	OFF	
6	TP	Down	Enable	Enable	----/----	----	----	Engineer
7	TP	Down	Enable	Enable	----/----	----	----	
8	TP	Down	Enable	Enable	----/----	----	----	sales

```

 9  TP  Down  Enable  Enable  ----/----  ----  ----
10  TP  Down  Enable  Disable ----/----  ----  ----
11  TP  Up   Enable  Disable 100M/Half  ON    ON
12  TP  Down  Enable  Disable ----/----  ----  ----
13  TP  Down  Enable  Disable ----/----  ----  ----
14  TP  Down  Enable  Disable ----/----  ----  ----
15  TP  Down  Enable  Disable ----/----  ----  ----
16  TP  Down  Enable  Enable  ----/----  ----  ----
.....
.....
25  TP  Down  Enable  Enable  ----/----  ----  ----
26  TP  Down  Enable  Enable  ----/----  ----  ----

```

FEL2P-SW26(port)#

show conf

Syntax:

show conf

Description:

To display the each port's configuration about state, speed-duplex and flow control.

Argument:

None.

Possible value:

None.

Example:

FEL2P-SW26 (port)# show conf

```

.....
.....
 3  Enable  Auto Mode  Symmetrictem
 4  Enable  Auto Mode  Symmetricto security mode
 5  Enable  Auto Mode  Symmetric
 6  Enable  Auto Mode  Symmetric
 7  Enable  Auto Mode  Symmetric
 8  Enable  Auto Mode  Symmetric
 9  Enable  Auto Mode  Asymmetric
10  Enable  10M/Full  Symmetric
11  Enable  10M/Full  Symmetric
12  Enable  10M/Full  Symmetric
13  Enable  10M/Full  Symmetric
14  Enable  10M/Full  Symmetric
15  Enable  10M/Full  Symmetric
16  Enable  Auto Mode  Symmetric
17  Enable  Auto Mode  Symmetric
18  Enable  Auto Mode  Symmetric
19  Enable  Auto Mode  Symmetric

```

20	Enable	Auto Mode	Symmetric
21	Enable	Auto Mode	Symmetric
22	Enable	Auto Mode	Symmetric
23	Enable	Auto Mode	Symmetric

show detail-counter

Syntax:

show detail-counter <#>

Description:

To display the detailed counting number of each port's traffic.

Argument:

<#> : port, available from 1 to 26

Possible value:

<#>:1 ~ 26

Example:

```
FEL2P-SW26 (port)# show detail-counter 6
```

```
FEL2P-SW26(port)# show detail-counter 1
```

Receive Total:

```
-----
Rx Packets                :                61731
Rx Octets                  :                54949069
Rx Errors                  :                    0
Rx Unicast Packets        :                42150
Rx Broadcast Packets      :                12752
Rx Multicast Packets      :                6829
Rx Pause Packets          :                    0
```

Receive Size Counters:

```
-----
Rx Undersize Packets      :                    0
Rx Oversize Packets       :                    0
```

Receive Error Counters:

```
-----
Rx FCS Errors             :                    0
Rx Alignment Errors       :                    0
Rx Fragments              :                    0
Rx Jabbers                :                    0
Rx Drop Packets           :                    0
```

.. (q to quit)

show media

Syntax:

show media <port>

Description:

To display the module 25 or 26 information.

Argument:

<port>: available 25, 26

Possible value:

<port>: 25, 26

Example:

```
FEL2P-SW26(port)# show media 25
Port 25 Fiber Media Information
```

```
-----
Connector Type      : SFP - Unknown or unspecified
Fiber Type          : Reserved
Tx Central Wavelength : 0
Baud Rate           : 1G
Vendor OUI          : 00:00:00
Vendor Name         : FIBERXON INC.
Vendor PN           : FTM-C012R-LC
Vendor Rev          : 10
Vendor SN           : PP220052901281
Date Code           : 051012
Temperature         : none
Vcc                 : none
Mon1 (Bias) mA     : none
Mon2 (TX PWR)      : none
Mon3 (RX PWR)      : none
```

```
FEL2P-SW26(port)#
```

show simple-counter**Syntax:**

```
show simple-counter
```

Description:

To display the summary counting of each port's traffic.

Argument:

None.

Possible value:

None.

Example:

```
FEL2P-SW26 (port)# show simple-counter
```

```
Port 1
Tx Octets      : 2346780           Rx Octets : 57965158
Tx Packets     : 28884            Rx Packets : 65171
Tx Collisions  : 0                Rx Errors  : 0
```

```
Port 2
Tx Octets      : 0                Rx Octets : 0
Tx Packets     : 0                Rx Packets : 0
Tx Collisions  : 0                Rx Errors  : 0
```

```

Port 3
Tx Octets      : 0
Tx Packets     : 0
Tx Collisions  : 0
...
...
... (q to quit)

```

show status

Syntax:

show status

Description:

To display the port's current status.

Argument:

None.

Possible value:

None.

Example:

```
FEL2P-SW26(port)# show status
```

Port	Media	Link	State	Auto	Nego.	Speed/Duplex	Rx Pause	Tx Pause
1	TP	Down	Enable	Enable	Enable	----/----	----	----
2	TP	Down	Enable	Enable	Enable	----/----	----	----
3	TP	Down	Enable	Enable	Enable	----/----	----	----
4	TP	Down	Enable	Enable	Enable	----/----	----	----
5	TP	Up	Enable	Enable	Enable	100M/Full	ON	ON
6	TP	Down	Enable	Enable	Enable	----/----	----	----
7	TP	Down	Enable	Enable	Enable	----/----	----	----
				:				
				:				
				:				
24	TP	Down	Enable	Enable	Enable	----/----	----	----
25	TP	Down	Enable	Enable	Enable	----/----	----	----
26	TP	Down	Enable	Enable	Enable	----/----	----	----

■ qos

disable 1p

Syntax:

disable 1p

Description:

To disable 802.1p qos.

Argument:

None.

Possible value:

None.

Example:

```
FEL2P-SW26 (qos)# disable 1p
```

disable dscp

Syntax:

```
disable dscp
```

Description:

To disable IP DSCP qos.

Argument:

None.

Possible value:

None.

Example:

```
FEL2P-SW26 (qos)# disable dscp
```

disable qos

Syntax:

```
disable qos
```

Description:

To disable qos function.

Argument:

None.

Possible value:

None.

Example:

```
FEL2P-SW26 (qos)# disable qos
```

enable 1p

Syntax:

```
enable 1p
```

Description:

To enable 802.1p qos.

Argument:

None.

Possible value:

None.

Example:

```
FEL2P-SW26 (qos)# enable 1p
```

enable dscp

Syntax:

enable dscp

Description:

To enable IP DSCP qos.

Argument:

None.

Possible value:

None.

Example:

```
FEL2P-SW26 (qos)# enable dscp
```

enable qos

Syntax:

enable qos

Description:

To enable qos function.

Argument:

None.

Possible value:

None.

Example:

```
FEL2P-SW26 (qos)# enable qos
```

enable tos

Syntax:

enable tos

Description:

To enable IP TOS qos.

Argument:

None.

Possible value:

None.

Example:

```
FEL2P-SW26 (qos)# enable tos
```

set dscp

Syntax:

```
set dscp [<q0><priority>] [<q1><priority>] [<q2><priority>] [<q3><priority>]
```

Description:

To set IP DSCP qos weighting for 4 queues.

Argument:

<q>: queue level, q0: queue 0; q1: queue 1; q2: queue 2; q3: queue 3
<priority>: priority level. One queue has been assigned 2 different priorities.

You don't need to use all of queues, but must assign queues in order

syntax: 1,2 or 2,5-7, available from 0 to 63.

Possible value:

<priority>: 0 to 63

Example:

```
FEL2P-SW26 (qos)# set dscp q0 2 q1 2 q2 2 q3 3
```

set pri-tag

Syntax:

```
set pri-tag [<q0><priority>] [<q1><priority>] [<q2><priority>] [<q3><priority>]
```

Description:

To set 802.1p qos weighting for 4 queues.

Argument:

<q>: queue level, q0: queue 0; q1: queue 1; q2: queue 2; q3: queue 3.

<priority>: priority level. One queue has been assigned 2 different priorities.

You don't need to use all of queues, but must assign queues in order.

Syntax: 1,2 or 2,5-7, available from 0 to 7.

Possible value:

<priority>: 0 to 7.

Example:

```
FEL2P-SW26(qos)# set pri-tag q0 0 q1 1 q2 2 q3 3
```

```
FEL2P-SW26(qos)# show priority-tag
```

```
802.1p priority
```

```
=====
```

```
Global QoS mode: Enable QoS
```

```
Enable 802.1p Priority
```

```
Enable ip diffserv classification
```

```
Scheduling: 4 WRR method.
```

```
weight: wrr 0 = 1; wrr 1 = 2; wrr 2 = 4; wrr 3 = 8.
```

```
weighted range: 1~55.
```

```
P0~7: Priority 0~7.
```

```
Default mode: Queue0: P0,P1; Queue1: P2,P3; Queue2: P4,P5; Queue3:
```

```
P6,P7.
```

	P0	P1	P2	P3	P4	P5	P6	P7
Queue	0	1	2	3	1	2	3	3

```
FEL2P-SW26(qos)#
```

set sche

Syntax:

```
set sche <wrr|strict> <wrr_0> <wrr_1> <wrr_2> <wrr_3>
```

Description:

To setup scheduling methods or weight.

Argument:

method : priority scheduling method

0: 4 WRR

1: 1 Strict + 3 WRR

2: 2 Strict + 2 WRR

3: 4 Strict

wrr_0 to 3: weighted for every queue. weighted range : 1-55.

Possible value:

<method>: 0-3

<wrr_0 to 3>: 1-55.

Example:

```
FEL2P-SW26(qos)# set sche 0 2 8 11 11
```

```
FEL2P-SW26(qos)# show pr
```

```
802.1p priority
```

```
=====
```

```
Global QoS mode: Enable QoS
```

```
Enable 802.1p Priority
```

```
Enable ip diffserv classification
```

```
Scheduling: 4 WRR method.
```

```
weight: wrr 0 = 2; wrr 1 = 8; wrr 2 = 11; wrr 3 = 11.  
weighted range: 1~55.
```

```
P0~7: Priority 0~7.
```

```
Default mode: Queue0: P0,P1; Queue1: P2,P3; Queue2: P4,P5; Queue3:  
P6,P7.
```

	P0	P1	P2	P3	P4	P5	P6	P7
Queue	0	1	2	3	1	2	3	3

```
FEL2P-SW26(qos)#
```

Possible value:

show dscp

Syntax:

```
show dscp
```

Description:

To show IP DSCP Qos configuration.

Argument:

None.

Possible value:

None.

Example:

```
FEL2P-SW26 (qos)# show dscp
```

```
ip diffserv classification
```

```
=====
```

```
Global QoS mode: Enable QoS
```

```
Disable 802.1p Priority
```

```
Disable ip tos classification
```



```

Scheduling:      Enable ip diffserv classification
                  weighted round robin method.
weight:          wrr 0 = 1; wrr 1 = 1; wrr 2 = 8; wrr 3 = 16.
                  weighted range: 1~55.
P0~63:          Priority 0~63.
Default mode:    Queue0: P0~15; Queue1: P16~31; Queue2: P32~47; Queue3:
P48~63.

```

DiffServ	Queue	DiffServ	Queue	DiffServ	Queue	DiffServ	Queue
0	0	1	0	2	0	3	0
4	0	5	0	6	0	7	0
8	0	9	0	10	0	11	0
12	0	13	0	14	0	15	0
16	1	17	1	18	1	19	1
20	1	21	1	22	1	23	1
24	1	25	1	26	1	27	1
28	1	29	1	30	1	31	1
32	2	33	2	34	2	35	2
36	2	37	2	38	2	39	2
40	2	41	2	42	2	43	2
44	2	45	2	46	2	47	2
48	3	49	3	50	3	51	3
52	3	53	3	54	3	55	3
56	3	57	3	58	3	59	3
60	3	61	3	62	3	63	3

show priority-tag

Syntax:

```
show priority-tag
```

Description:

To show 802.1p QoS configuration.

Argument:

None.

Possible value:

None.

Example:

```
FEL2P-SW26 (qos)# show priority-tag
```

```
802.1p priority
```

```
=====
```

```
Global QoS mode: Enable QoS
```

```
                  Enable 802.1p Priority
```

```
                  Enable ip diffserv classification
```

```
Scheduling:
```

```
                  4 WRR method.
```

```
weight:
```

```
                  wrr 0 = 2; wrr 1 = 8; wrr 2 = 11; wrr 3 = 11.
```

```
                  weighted range: 1~55.
```

P0~7: Priority 0~7.
Default mode: Queue0: P0,P1; Queue1: P2,P3; Queue2: P4,P5; Queue3:
P6,P7.

	P0	P1	P2	P3	P4	P5	P6	P7
Queue	0	1	2	3	1	2	3	3

FEL2P-SW26(qos)#

■ reboot

reboot

Syntax:

reboot

Description:

To reboot the system.

Argument:

None.

Possible value:

None.

Example:

FEL2P-SW26 # reboot

■ security

<<isolated-group>>

set

Syntax:

set <port>

Description:

To set up the function of the isolated group.

Argument:

<port> : isolated port; range syntax: 1,5-7, available from 0 to 26
set 0 as disabled

Possible value:

<port>:0 to 26

Example:

FEL2P-SW26(security-isolated-group)# set 9,10-14

FEL2P-SW26(security-isolated-group)# show

Isolated group:

9 10 11 12 13 14

FEL2P-SW26(security-isolated-group)#

show

Syntax:

show

Description:

To display the current setting status of isolated group.

Argument:

None.

Possible value:

None.

Example:

```
FEL2P-SW26 (security-isolated-group)# set 9,10-14
```

```
FEL2P-SW26 (security-isolated-group)# show  
Isolated group:  
9 10 11 12 13 14
```

```
FEL2P-SW26 (security-isolated-group)#
```

<<mirror>>

disable

Syntax:

disable

Description:

To disable the function of mirror.

Argument:

None.

Possible value:

None.

Example:

```
FEL2P-SW26 (security-mirror)# disable
```

enable

Syntax:

enable

Description:

To enable the function of mirror.

Argument:

None.

Possible value:

None.

Example:

```
FEL2P-SW26 (security-mirror)# enable
```

set

Syntax:

set <spy> <ingress> <egress>

Description:

To set up the monitoring port and monitored ports of the mirror (ingress/egress) function. User can monitor the ports that receive or transmit the packets.

Argument:

<spy> : Monitoring port

<ingress> : monitored ingress port; range syntax: 1,5-7, available from 0 to 26

<egress> : monitored egress port; range syntax: 1,5-7, available from 0 to 26

set ingress/egress to 0 as ingress/egress disabled

Possible value:

<ingress>: 0 to 26

<egress>: 0 to 26

Example:

```
FEL2P-SW26(security-mirror)# set 9 1-10 1-10
```

```
FEL2P-SW26(security-mirror)# show
```

```
Mirror:
```

```
Monitoring Port   :9
```

```
Monitored Ingress :
```

```
Monitored Egress  :
```

```
FEL2P-SW26(security-mirror)#
```

show

Syntax:

show

Description:

To display the current setting status of mirror.

Argument:

None.

Possible value:

None.

Example:

```
FEL2P-SW26 (security-mirror)# show
```

```
Mirror:
```

```
Monitoring Port   :1
```

```
Monitored Ingress :4
```

```
Monitored Egress  :2 3
```

■ **snmp**

disable

Syntax:

disable set-community

disable snmp

Description:

The Disable here is used for the de-activation of snmp or set-community.

Argument:

None.

Possible value:

None.

Example:

```
FEL2P-SW26 (snmp)# disable set-community
```

```
FEL2P-SW26 (snmp)# disable snmp
```

enable**Syntax:**

```
enable set-community
```

```
enable snmp
```

Description:

The Enable here is used for the activation snmp or set-community.

Argument:

None.

Possible value:

None.

Example:

```
FEL2P-SW26 (snmp)# enable set-community
```

```
FEL2P-SW26 (snmp)# enable snmp
```

set**Syntax:**

```
set get-community <community>
```

```
set set-community <community>
```

```
set trap <#> <ip> [port] [community]
```

Description:

The Set here is used for the setup of get-community, set-community, trap host ip, host port and trap- community.

Argument:

<#>: trap number, range: 1 to 6

<ip>: ip address or domain name

<port>: trap port

<community>: community name

Possible value:

<trap number> : 1 to 6

<port> :1~65535

Example:

```
FEL2P-SW26 (snmp)# set get-community public
```

```
FEL2P-SW26 (snmp)# set set-community private
```

```
FEL2P-SW26 (snmp)# set trap 1 192.168.1.1 162 public
```

show**Syntax:**

```
show
```

Description:

The Show here is to display the configuration of SNMP.

Argument:

None.

Possible value:

None.

Example:

```
FEL2P-SW26 (snmp)# show
SNMP          : Enable
Get Community: public
Set Community: private [Enable]
Trap Host 1 IP Address: 192.168.1.1 Port: 162 Community: public
Trap Host 2 IP Address: 0.0.0.0 Port: 162 Community: public
Trap Host 3 IP Address: 0.0.0.0 Port: 162 Community: public
Trap Host 4 IP Address: 0.0.0.0 Port: 162 Community: public
Trap Host 5 IP Address: 0.0.0.0 Port: 162 Community: public
Trap Host 6 IP Address: 0.0.0.0 Port: 162 Community: public
```

■ stp***MCheck*****Syntax:**

MCheck <range>

Description:

To force the port to transmit RST BPDUs.

Argument:

<range>: syntax 1,5-7, available from 1 to 26

Possible value:

<range>: 1 to 26

Example:

```
FEL2P-SW26 (stp)# Mcheck 1-8
```

disable**Syntax:**

disable

Description:

To disable the function of STP.

Argument:

None.

Possible value:

None.

Example:

```
FEL2P-SW26 (stp)# disable
```

enable**Syntax:**

enable

Description:

To enable the function of STP.

Argument:

None.

Possible value:

None.

Example:

```
FEL2P-SW26 (stp)# enable
```

set config

Syntax:

```
set config <Bridge Priority> <Hello Time> <Max. Age> <Forward Delay>
```

Description:

To set up the parameters of STP.

Argument:

<Bridge Priority>: priority must be a multiple of 4096, available from 0 to 61440.

<Hello Time>: available from 1 to 10.

<Max. Age>: available from 6 to 40.

<Forward Delay>: available from 4 to 30.

Note: $2 * (\text{Forward Delay} - 1) \geq \text{Max Age}$

$\text{Max Age} \geq 2 * (\text{Hello Time} + 1)$

Possible value:

<Bridge Priority>: 0 to 61440.

<Hello Time>: 1 to 10.

<Max. Age>: 6 to 40.

<Forward Delay>: 4 to 30.

Example:

```
FEL2P-SW26 (stp)# set config 61440 2 20 15
```

set port

Syntax:

```
set port <range> <path cost> <priority> <edge_port> <admin p2p>
```

Description:

To set up the port information of STP.

Argument:

<range>: syntax 1,5-7, available from 1 to 26

<path cost>: 0, 1-200000000. The value zero means auto status

<priority>: priority must be a multiple of 16, available from 0 to 240

<edge_port>: Admin Edge Port, <yes|no>

<admin p2p>: Admin point to point, <auto|true|false>

Possible value:

<range> :1 to 26 <path cost>: 0, 1-200000000.

<priority> : 0 to 240 <edge_port> : yes / no

<admin p2p>: auto / true / false

Example:

```
FEL2P-SW26 (stp)# set port 1-16 0 128 yes auto
```

set version

Syntax:

set version <stp|rstp>

Description:

To set up the version of STP.

Argument:

<stp|rstp>:stp / rstp

Possible value:

<stp|rstp>:stp / rstp

Example:

```
FEL2P-SW26 (stp)# set version rstp
```

show config

Syntax:

show config

Description:

To display the STP configuration data.

Argument:

None.

Possible value:

None.

Example:

```
FEL2P-SW26 (stp)# show config
STP State Configuration :
Spanning Tree Protocol      : Enabled
Bridge Priority (0-61440)   : 61440
Hello Time (1-10 sec)      : 2
Max. Age (6-40 sec)        : 20
Forward Delay (4-30 sec)   : 15
Force Version                : RSTP
```

show port

Syntax:

show port

Description:

To display the port information of STP.

Argument:

None.

Possible value:

None.

Example:

```
FEL2P-SW26 (stp)# show port
Port Port Status Path Cost Priority Admin Edge Port Admin Point To Point
==== =====
1 DISCARDING 2000000 128 Yes Auto
2 DISCARDING 2000000 128 Yes Auto
3 DISCARDING 2000000 128 Yes Auto
```

4	DISCARDING	2000000	128	Yes	Auto
5	DISCARDING	2000000	128	Yes	Auto
		:			
		:			
		:			
23	DISCARDING	200000	128	No	Auto
24	DISCARDING	200000	128	No	Auto
25	DISCARDING	20000	128	No	Auto
26	DISCARDING	20000	128	No	Auto

show status

Syntax:

show status

Description:

To display of the status of STP.

Argument:

None.

Possible value:

None.

Example:

```
FEL2P-SW26 (stp)# show status
```

```
STP Status :
```

```
STP State : Enabled
```

```
Bridge ID : 00:40:C7:D8:09:1D
```

```
Bridge Priority : 61440
```

```
Designated Root : 00:40:C7:D8:09:1D
```

```
Designated Priority : 61440
```

```
Root Port : 0
```

```
Root Path Cost : 0
```

```
Current Max. Age(sec) : 20
```

```
Current Forward Delay(sec) : 15
```

```
Hello Time(sec) : 2
```

```
STP Topology Change Count : 0
```

```
Time Since Last Topology Change(sec) : 848
```

■ system

set contact

Syntax:

```
set contact <contact>
```

Description:

To set the contact description of the switch.

Argument:

<contact>:string length up to 40 characters.

Possible value:

<contact>: A, b, c, d, ... ,z and 1, 2, 3, etc.

Example:

```
FEL2P-SW26 (system)# set contact Taipei
```

set device-name

Syntax:

```
set device-name <device-name>
```

Description:

To set the device name description of the switch.

Argument:

<device-name>: string length up to 40 characters.

Possible value:

<device-name>: A, b, c, d, ... ,z and 1, 2, 3, etc.

Example:

```
FEL2P-SW26 (system)# set device-name CR-2600
```

set location

Syntax:

```
set location <location>
```

Description:

To set the location description of the switch.

Argument:

<location>: string length up to 40 characters

Possible value:

<location>: A, b, c, d, ... ,z and 1, 2, 3, etc.

Example:

```
FEL2P-SW26 (system)# set location Taipei
```

show

Syntax:

```
show
```

Description:

To display the basic information of the switch.

Argument:

None.

Possible value:

None.

Example:

```
FEL2P-SW26 (system)# show
```

```
Model Name                : FEL2P-SW26
```

```
System Description        : 24 Fast Ethernet + 2 Gigabit L2 Managed  
                          Switch
```

```
Location                  :
```

Contact :
Device Name : FEL2P-SW26
System Up Time : 0 Days 22 Hours 29 Mins 31 Secs
Current Time : Wed Aug 31 14:03:33 2005
BIOS Version : v1.03
Firmware Version : v2.04
Hardware-Mechanical Version : v65535.65535-v0.04
Serial Number : 123
Host IP Address : 192.168.1.1
Host MAC Address : 00-40-c7-08-00-00
Device Port : UART * 1 TP *24 Fiber * 2
RAM Size : 16 M
Flash Size : 2 M

■ tftp

set server

Syntax:

set server <ip>

Description:

To set up the IP address of tftp server.

Argument:

<ip>: the IP address of tftp server

Possible value:

<ip>: tftp server IP

Example:

FEL2P-SW26 (tftp)# set server 192.168.3.111

show

Syntax:

show

Description:

To display the information of tftp server.

Argument:

None

Possible value:

None

Example:

FEL2P-SW26 (tftp)# show

Tftp Server : 192.168.3.111

■ time

set daylightsaving

Syntax:

set daylightsaving <hr> <MM/DD/HH> <mm/dd/hh>

Description:

To set up the daylight saving.

Argument:

<hr> : daylight saving hour, range: -5 to +5
<MM> : daylight saving start Month (01-12)
<DD> : daylight saving start Day (01-31)
<HH> : daylight saving start Hour (00-23)
<mm> : daylight saving end Month (01-12)
<dd> : daylight saving end Day (01-31)
<hh> : daylight saving end Hour (00-23)

Possible value:

<hr> : -5 to +5
<MM> : (01-12)
<DD> : (01-31)
<HH> : (00-23)
<mm> : (01-12)
<dd> : (01-31)
<hh> : (00-23)

Example:

```
FEL2P-SW26(time)# set daylightsaving -5 10/31/00 12/31/00
```

```
FEL2P-SW26(time)# show
```

```
Current Time          : Tue Apr 08 10:28:54 2008  
NTP Server            : 209.81.9.7  
Timezone              : 8  
Day light Saving      : -5 Hours  
Day light Saving Start: Mth: 10 Day: 31 Hour: 0  
Day light Saving End  : Mth: 12 Day: 31 Hour: 0
```

set manual

Syntax:

set manual <YYYY/MM/DD> <hh:mm:ss>

Description:

To set up the current time manually.

Argument:

<YYYY> : Year (2000-2036) <MM> : Month (01-12)
<DD> : Day (01-31) <hh> : Hour (00-23)
<mm> : Minute (00-59) <ss> : Second (00-59)

Possible value:

<YYYY> : (2000-2036) <MM> : (01-12)
<DD> : (01-31) <hh> : (00-23)
<mm> : (00-59) <ss> : (00-59)

Example:

```
FEL2P-SW26(time)# set manual 2008/04/08 11:24:00
```

```
FEL2P-SW26(time)# show
Current Time          : Tue Apr 08 11:24:02 2008
NTP Server           : 209.81.9.7
Timezone             : 8
Day light Saving     : -5 Hours
Day light Saving Start: Mth: 10 Day: 31 Hour: 0
Day light Saving End  : Mth: 12 Day: 31 Hour: 0
```

```
FEL2P-SW26(time)#
```

set ntp

Syntax:

```
set ntp <ip> <timezone>
```

Description:

To set up the current time via NTP server.

Argument:

<ip>: ntp server ip address or domain name

<timezone>: time zone (GMT), range: -12 to +13

Possible value:

<timezone>: -12,-11...,0,1...,13

Example:

```
FEL2P-SW26(time)# set ntp 192.168.2.22 8
Synchronizing... (1)
Synchronization success
```

show

Syntax:

```
show
```

Description:

To show the time configuration, including "Current Time", "NTP Server", "Timezone", "Daylight Saving", "Daylight Saving Start" and "Daylight Saving End"

Argument:

None.

Possible value:

None.

Example:

```
FEL2P-SW26(time)# show
Current Time          : Wed Apr 21 06:16:22 2005
NTP Server           : 209.81.9.7
Timezone             : 8
Day light Saving     : 4 Hours
Day light Saving Start: Mth: 2 Day: 20 Hour: 10
Day light Saving End  : Mth: 3 Day: 20 Hour: 10
FEL2P-SW26 (time)#
```

■ trunk

del trunk

Syntax:

del trunk <port-range>

Description:

To remove the trunk port.

Argument:

<port-range> : syntax 1,5-7, available from 1 to 26

Possible value:

<port-range> : 1 to 26

Example:

```
FEL2P-SW26 (trunk)# del trunk 1
```

set hash

Syntax:

set hash <method>

Description:

To set up trunk hash method.

Argument:

<method>: lacp hash method

0: DA and SA

1: SA

2: DA

Note : This hash method applies to both LACP and static trunk.

Possible value:

<method>: 0~2

Example:

```
FEL2P-SW26 (trunk)# set hash 2
```

set priority

Syntax:

set priority <range>

Description:

To set up the LACP system priority.

Argument:

<range>:available from 1 to 65535.

Possible value:

<range>:1 to 65535.

Example:

```
FEL2P-SW26 (trunk)# set priority 33333
```

set trunk

Syntax:

set trunk <port-range> <method> <group> <active LACP>

Description:

To set up the status of trunk, including the group number and mode of the trunk as well as LACP mode.

Argument:

<port-range> : syntax 1,5-7, available from 1 to 26

<method>: <static|lacp>

static : adopt the static link aggregation

lacp : adopt the dynamic link aggregation- link aggregation control protocol

<group>: 1-3.

<active LACP>: <passive|active>

active : set the LACP to active mode

passive : set the LACP to passive mode

Possible value:

<port-range> : 1 to 26

<method>: static or lacp

<group>: 1-3.

<active LACP>: active or passive

Example:

```
FEL2P-SW26 (trunk)# set trunk 2-5 lacp 1 active
```

show aggtr-view

Syntax:

show aggtr-view

Description:

To display the aggregator list.

Argument:

None.

Possible value:

None.

Example:

```
FEL2P-SW26 (trunk)# show aggtr-view
```

```
Aggregator 1) Method: None
              Member Ports: 1
              Ready Ports:1
```

```
Aggregator 2) Method: LACP
              Member Ports: 2
              Ready Ports:
```

:

⋮
⋮

show lacp-config

Syntax:

show lacp-config

Description:

To display the value of LACP Priority.

Argument:

None.

Possible value:

None.

Example:

```
FEL2P-SW26 (trunk)# show lacp-config
LACP System Priority : 33333
Hash Method        : DA
```

show lacp-detail

Syntax:

show lacp-detail <aggr>

Description:

To display the detailed information of the LACP trunk group.

Argument:

<aggr> : aggregator, available from 1 to 26

Possible value:

<aggr> : 1 to 26

Example:

```
FEL2P-SW26 (trunk)# show lacp-detail 2
```

Aggregator 2 Information:

Actor			Partner	
System Priority	MAC Address		System Priority	MAC Address
32768	00-40-c7-e8-00-02		32768	00-00-00-00-00-00
Port	Key	Trunk Status	Port	Key
2	257	---	2	0

show status

Syntax:

show status

Description:

To display the aggregator status and the settings of each port.

Argument:

None.

Possible value:

None.

Example:

FEL2P-SW26 (trunk)# show status

Trunk Port Setting				Trunk Port Status	
port	Method	Group	Active LACP	Aggtregator	Status
1	None	0	Active	1	Ready
2	LACP	1	Active	2	---
3	LACP	1	Active	3	---
4	LACP	1	Active	4	---
5	LACP	1	Active	5	---
6	None	0	Active	6	---
7	None	0	Active	7	---
8	None	0	Active	8	---
9	None	0	Active	9	---
10	None	0	Active	10	---
11	None	0	Active	11	---
12	None	0	Active	12	---
13	None	0	Active	13	---
14	None	0	Active	14	---
15	None	0	Active	15	---
16	None	0	Active	16	---
17	None	0	Active	17	---
18	None	0	Active	18	---
19	None	0	Active	19	---
20	None	0	Active	20	---
21	None	0	Active	21	---
22	None	0	Active	22	---
23	None	0	Active	23	---
24	None	0	Active	24	---
25	None	0	Active	25	---
26	None	0	Active	26	---

■ vlan***del port-group*****Syntax:**

del port-group <name>

Description:

To delete the port-based vlan group.

Argument:

<name>: port-vlan name

Possible value:

<name>: port-vlan name

Example:

```
FEL2P-SW26 (vlan)# del port-group vlan-2
```

del tag-group

Syntax:

```
del tag-group <vid>
```

Description:

To delete the tag-based vlan group.

Argument:

<vid>: vlan ID, available from 1 to 4094

Possible value:

<vid>: 1 to 4094

Example:

```
FEL2P-SW26 (vlan)# del tag-group 2
```

disable double-tag

Syntax:

```
disable double-tag
```

Description:

To disable double-tag.

Argument:

None.

Possible value:

None.

Example:

```
FEL2P-SW26 (vlan)# disable double-tag
```

disable drop-untag

Syntax:

```
disable drop-untag <port_range>
```

Description:

To disable drop-untag.

Argument:

<port_range>: which port(s) you want not to drop untagged frames. Syntax: 1,5-7, available from 1 to 26

Possible value:

<port_range>: 1 to 26

Example:

```
FEL2P-SW26 (vlan)# disable drop-untag 2,4,5-7
```

disable svl

Syntax:

```
disable svl
```

Description:

To enable Independent VLAN Learning.

Argument:

None.

Possible value:

None.

Example:

```
FEL2P-SW26 (vlan)# disable svl
```

disable symmetric**Syntax:**

```
disable symmetric
```

Description:

To Not drop frames from the non-member port.

Argument:

None.

Possible value:

None.

Example:

```
FEL2P-SW26 (vlan)# disable symmetric
```

enable double-tag**Syntax:**

```
enable double-tag
```

Description:

To enable double-tag.

Argument:

None.

Possible value:

None.

Example:

```
FEL2P-SW26 (vlan)# enable double-tag
```

enable drop-untag**Syntax:**

```
enable drop-untag <port_range>
```

Description:

To enable drop-untag.

Argument:

<port_range>: which port(s) you want to drop untagged frames. Syntax: 1,5-7, available from 1 to 26

Possible value:

<port_range>: 1 to 26

Example:

```
FEL2P-SW26 (vlan)# enable drop-untag 2,4,5-7
```

enable svl**Syntax:**

```
enable svl
```

Description:

To enable Shared VLAN Learning.

Argument:

None.

Possible value:

None.

Example:

```
FEL2P-SW26 (vlan)# enable svl
```

enable symmetric**Syntax:**

```
enable symmetric
```

Description:

To drop frames from the non-member port.

Argument:

None.

Possible value:

None.

Example:

```
FEL2P-SW26 (vlan)# enable symmetric
```

set mgt-vlan**Syntax:**

```
set mgt-vlan <state> [vid]
```

Description:

To set management vlan function on switch..

Argument:

<state> : 0 for disable; 1 for enable

<vid> : vlan id, from 1 to 4094

Possible value:

<state> : 0 for disable; 1 for enable

<vid > : 1 to 4094

Example:

```
FEL2P-SW26(vlan)# set mgt-vlan 1 33
```

```
FEL2P-SW26(vlan)# show mgt-vlan
```

```
Management Vlan:
```

```
State : Enable
```

```
VID   : 33
```

```
FEL2P-SW26(vlan)#
```

set mode

Syntax:

set mode <port | tag | metro #>

Description:

To switch vlan mode between port-based and tag-based modes.

Argument:

<tag> : set tag-based vlan

<port> : set port-based vlan

<metro> : set metro mode vlan

#: up-link port type

0: 25 port

1: 26 port

2: 25 and 26 port

Possible value:

<tag>: set tag-based vlan

<port>: set port-based vlan

<metro> : set metro mode vlan

#: up-link port type

0: 25 port

1: 26 port

2: 25 and 26 port

Example:

```
FEL2P-SW26(vlan)# set mode tag 0
```

set port-group

Syntax:

set port-group <name> <range>

Description:

To add or edit a port-based vlan group.

Argument:

<name>: port-vlan name

<range>: vlan group members, syntax: 1,5-7, available from 1 to 26

Possible value:

<range>: 1 to 26

Example:

```
FEL2P-SW26 (vlan)# set port-group vlan-1 2-5,6-10
```

set pvid

Syntax:

set pvid <port_range> <pvid> <default_priority>

Description:

To set vlan PVID and port priority.

Argument:

<port_range>: which port(s) you want to set PVID(s). Syntax 1,5-7, available from 1 to 26

<pvid>: which PVID you want to set, available from 1 to 4094
<default_priority>: which priority you want to set, available from 0 to 7

Possible value:

<port_range>: 1 to 26

<pvid>: 1 to 4094

<default_priority>: 0 to 7

Example:

```
FEL2P-SW26 (vlan)# set pvid 3,5,6-8 5 6
```

set tag-group

Syntax:

```
set tag-group <vid> <name> <member_range> <untag_range>
```

Description:

To add or edit the tag-based vlan group.

Argument:

<vid>: vlan id, from 1 to 4094

<name>: tag-vlan group name

<member_range>: member port; syntax: 1,5-7, available from 1 to 26

<untag_range>: untagged out port; syntax: 1,5-7, available from 0 to 26

set untag_range to 0 as none of the ports are force untagged

Possible value:

<vid>: 1 to 4094

<member_range>: 1 to 26

<untag_range>: 0 to 26

Example:

```
FEL2P-SW26 (vlan)# set tag-group 2 vlan-2 2-5,6,15-13 0
```

show config

Syntax:

```
show config
```

Description:

To display the current vlan mode, Symmetric vlan, SVL and Double tag states.

Argument:

None.

Possible value:

None.

Example:

```
FEL2P-SW26 (vlan)# show config
```

```
Current vlan mode:Tag-based vlan
```

```
Global setting:
```

```
Symmetric vlan : Disable (Asymmetric)
```

```
SVL : Disable (IVL)
```

```
Double tag : Disable
```

show group

Syntax:

show group

Description:

To display vlan mode and vlan group.

Argument:

None

Possible value:

None

Example:

```
FEL2P-SW26 (vlan)# show group
```

Vlan mode is tag-based.

```
1) Name :default
   VID  :1
   Member:1 2 3 4 5 6 7 8 9 10 11 12 13 14 15 16 17 18 19 20 21 22 23 24
          25 26
   Untag :1 2 3 4 5 6 7 8 9 10 11 12 13 14 15 16 17 18 19 20 21 22 23 24
          25 26
2) Name :VLAN-2
   VID  :2
   Member:2 3 4 5 6 13 14 15
   Untag :
```

show pvid

Syntax:

show pvid

Description:

To display pvid, priority and drop untag result.

Argument:

None

Possible value:

None

Example:

```
FEL2P-SW26 (vlan)# show pvid
```

Port	PVID	Priority	Drop Untag
1	1	0	Disable
2	1	0	Disable
3	5	6	Disable
4	1	0	Disable
5	5	6	Disable
6	5	6	Disable
7	5	6	Disable
8	5	6	Disable
9	1	0	Disable
10	1	0	Disable
11	1	0	Disable
12	1	0	Disable

13	1	0	Disable
14	1	0	Disable
15	1	0	Disable
16	1	0	Disable
17	1	0	Disable

■ vs

disable

Syntax:

disable

Description:

To disable the virtual stack.

Argument:

None.

Possible value:

None.

Example:

```
FEL2P-SW26(vs)# disable
```

enable

Syntax:

enable

Description:

To enable the virtual stack.

Argument:

None.

Possible value:

None.

Example:

```
FEL2P-SW26 (vs)# enable
```

set gid

Syntax:

```
set gid <gid>
```

Description:

To set the group id.

Argument:

<gid>: group ID

Possible value:

<gid>: a-z,A-Z,0-9

Example:

```
FEL2P-SW26 (vs)# set gid group1
```

set role

Syntax:

set role <master|slave>

Description:

To set role.

Argument:

<master|slave>: master: act as master, slave : act as slave

Possible value:

<master|slave>: master or slave

Example:

```
FEL2P-SW26 (vs)# set role master
```

show**Syntax:**

show

Description:

To display the configuration of the virtual stack.

Argument:

None.

Possible value:

None.

Example:

```
FEL2P-SW26 (vs)# show
```

Virtual Stack Config:

State : Enable

Role : Master

Group ID : group1

5. Maintenance

5-1. Resolving No Link Condition

The possible causes for a no link LED status are as follows:

- The attached device is not powered on
- The cable may not be the correct type or is faulty
- The installed building premise cable is faulty
- The port may be faulty

5-2. Q&A

1. Computer A can connect to Computer B, but cannot connect to Computer C through the Managed Switch.
 - ✓ The network device of Computer C may fail to work. Please check the link/act status of Computer C on the LED indicator. Try another network device on this connection.
 - ✓ The network configuration of Computer C may be something wrong. Please verify the network configuration on Computer C.
2. The uplink connection function fails to work.
 - ✓ The connection ports on another must be connection ports. Please check if connection ports are used on that Managed Switch.
 - ✓ Please check the uplink setup of the Managed Switch to verify the uplink function is enabled.
3. The console interface cannot appear on the console port connection.
 - ✓ The COM port default parameters are [Baud Rate: 57600, Data Bits: 8, Parity Bits: None, Stop Bit: A, Flow Control: None]. Please check the COM port property in the terminal program. And if the parameters are changed, please set the COM configuration to the new setting.
 - ✓ Check the RS-232 cable is connected well on the console port of the Managed Switch and COM port of PC.
 - ✓ Check if the COM of the PC is enabled.
4. How to configure the Managed Switch?
 - ✓ The "Hyperterm" is the terminal program in Win95/98/NT. Users can also use any other terminal programs in Linux/Unix to configure the Managed Switch. Please refer to the user guide of that terminal program. But the COM port parameters (baud rate/ data bits/ parity bits/ flow control) must be the same as the setting of the console port of the Managed Switch.

Appendix A

Technical Specifications

Features

- The switch included 24-Port 10/100Mbps TP and 2-Port Gigabit Dual Media TP/SFP or TP/GBIC.
- Supports 24-port 10/100M TP ports with Nway and auto MDIX function.
- MSM-6226 supports 2 Gigabit dual media ports(TP/SFP) and 2 slots for removable SFP module supporting 1000M SFP fiber module.
- MSM-6226 supports 2 Gigabit dual media ports(TP/GBIC) and 2 slots for removable GBIC module supporting 1000M GBIC fiber module.
- Supports on-line plug/unplug SFP/GBIC transceiver modules.
- Non-blocking, store-and-forward and shared-memory L2 managed switch.
- Supports auto-negotiation for configuring speed, duplex mode.
- Supports 802.3x flow control for full-duplex ports.
- Supports collision-based and carrier-based backpressure for half-duplex ports.
- 256-entry Multicast Address table.
- Any ports can be in disable mode, force mode or auto-polling mode.
- Per-port ingress/egress rate control with 64K/128K/256K (up to 100Mbps) resolution.
- Supports Head of Line (HOL) blocking prevention.
- Supports broadcast storm filtering.
- 8K MAC addresses with automatic learning and aging.
- Auto-aging with programmable inter-age time.
- Supports 802.1p Class of Service with 4-level priority queuing.
- Supports port sniffer function with 3 modes:
(TX Monitor Mode, RX Monitor Mode and TX-RX pair Monitor Mode).
- Supports port-based VLAN, 802.1Q tag-based VLAN with 4K entries.
- Efficient self-learning and address recognition mechanism enables forwarding rate at wire speed.
- Web-based management provides the ability to completely manage the switch from any web browser.
- SNMP/Telnet interface delivers complete in-band management.
- Supports IEEE 802.1D Spanning Tree Protocol.
- Supports IEEE 802.1w Rapid Spanning Trees.
- Supports IEEE 802.1X port-based network access control.
- Supports IP Multicasting to implement IGMP Snooping function.
- Supports 802.3ad port trunking with flexible load distribution and failover function.
- Supports ingress port security mode for VLAN Tagged and Untagged frame process.
- Supports SNMP MIB2 and RMON sampling with sampled packet error indication.
- Power Saving with "ActiPHY Power Management" and "PerfectReach Power Management" techniques.
- Supports Link Layer Discovery Protocol (LLDP, IEEE802.1AB)

Hardware Specifications

- **Standard Compliance:** IEEE802.3ab / 802.3z / 802.3u / 802.3x
802.3z and 802.3ab compliant Gigabit Ethernet ports

- **Network Interface of Option transceiver:**

Configuration	Mode	Connector	Port
SFP.0LC.202	1000FDX	*LC M-M	2(Option)
SFP.0LC.212.XX	1000FDX	*LC S-M	2(Option)
SFP.0BL.621.20X	1000FDX	*BiDi-LC S-M	2(Option)
GBI.ZSC.202	1000FDX	*SC M-M	2(Option)
GBI.ZSC.212.XX	1000FDX	*SC S-M	2(Option)
GBI.ZSC.621.20X	1000FDX	*BiDi-SC S-M	2(Option)

* : Default module

- **Transmission Mode:** 10/100Mbps support full or half duplex
1000Mbps support full duplex only
- **Transmission Speed:** 10/100/1000Mbps for TP
1000Mbps for Fiber
- **Full Forwarding/Filtering Packet Rate:** PPS (packets per second)

Forwarding Rate	Speed
1,488,000PPS	1000Mbps
148,800PPS	100Mbps
14,880PPS	10Mbps

- **MAC Address and Self-learning:** 8K address table entries,
256 VLAN table entries,
256 IP multicast table entries,
- **Buffer Memory:** Embedded 256KB packet buffers and 128KB control memory.
- **Flow Control:** IEEE802.3x compliant for full duplex
Backpressure flow control for half duplex
- **Cable and Maximum Length:**

TP	Cat. 5 UTP cable, up to 100m
1000Base-SX SC M-M	Up to 220/275/500/550m, which depends on Multi-Mode Fiber type
1000Base-LX SC S-M	Single-Mode Fiber, up to 10/30/50Km
1000Base-FX WDM SC S-M	Single Fiber, BiDi 20Km

- **Diagnostic LED:**

System LED :

Power
CPURUN
ACT (LEDSET)
FDX (LEDSET)
SPD (LEDSET)

Per Port LED:

10/100M TP Port 1 to 24

: LINK/ACT, FDX, SPD

1000M Fiber/TP Port 25,26 : LINK/ACT, FDX, SPD

- **Power Requirement** : AC Line
 - Voltage : 100~240 V
 - Frequency : 50~60 Hz
 - Consumption : 15W
- **Ambient Temperature** : -10°C ~ 60 °C
- **Humidity** : 5% ~ 90%
- **Dimensions** : 44(H) × 442(W) × 209(D) mm
- **Comply with FCC Part 15 Class A & CE Mark Approval**

Management Software Specifications

System Configuration	Auto-negotiation support on 10/100Base-TX ports, Web browser or console interface can set transmission speed (10/100Mbps) and operation mode (Full/Half duplex) on each port, enable/disable any port, set VLAN group, set Trunk Connection.
Management Agent	SNMP support; MIB II, Bridge MIB, RMON MIB
Spanning Tree Algorithm	IEEE 802.1D
VLAN Function	Port-Base / 802.1Q-Tagged, allowed up to 256 active VLANs in one switch.
Trunk Function	Ports trunk connections allowed
IGMP	IP Multicast Filtering by passively snooping on the IGMP Query.
Bandwidth Control	Supports by-port Egress/Ingress rate control
Quality of Service (QoS)	Referred as Class of Service (CoS) by the IEEE 802.1P standard Four queues per port Packet transmission schedule using Weighted Round Robin (WRR) User-defined weight Classification of packet priority can be based on either a VLAN tag on packet or a user-defined port priority.
Port Security	Limit number of MAC addresses learned per port static MAC addresses stay in the filtering table.
Internetworking Protocol	Bridging : 802.1D Spanning Tree IP Multicast : IGMP Snooping IP Multicast Packet Filtering Maximum of 256 active VLANs and IP multicast sessions
Network Management	One RS-232 port as local control console Telnet remote control console SNMP agent : MIB-2 (RFC 1213) Bridge MIB (RFC 1493) RMON MIB (RFC 1757)-statistics Ethernet-like MIB (RFC 1643) Web browser support based on HTTP Server and CGI parser TFTP software-upgrade capability.

Note: Any specification is subject to change without notice.

Appendix B

Null Modem Cable Specifications

The DB-9 cable is used for connecting a terminal or terminal emulator to the Managed Switch's RS-232 port to access the command-line interface.

The table below shows the pin assignments for the DB-9 cable.

Function	Mnemonic	Pin
Carrier	CD	1
Receive Data	RXD	2
Transmit Data	TXD	3
Data Terminal Ready	DTR	4
Signal Ground	GND	5
Data Set Ready	DSR	6
Request To Send	RTS	7
Clear To Send	CTS	8

9 Pin Null Modem Cable

CD	1	_____	4	DTR
DSR	6	_____	1	CD
DTR	4	_____	6	DSR
RXD	2	_____	3	TXD
TXD	3	_____	2	RXD
GND	5	_____	5	GND
RTS	7	_____	8	CTS
CTS	8	_____	7	RTS
Reserve	9	_____	9	Reserve

